



Published by
the New Jersey Department of Agriculture —
State Soil Conservation Committee



Cover: Restoration of 800 feet of the Ramapo River bank after damage by Hurricane Irene in August 2011. Restoration by the Boro of Oakland, Bergen County NJ Spring 2013 (completed). Technical and funding assistance from the USDA Natural Resources Conservation Service. Erosion Control oversight by the Bergen County Soil Conservation District.

STANDARDS
FOR
SOIL EROSION AND SEDIMENT CONTROL IN NEW JERSEY

Adopted
December 2013

Vegetative and Engineering Standards, chapters 1 - 32 inclusive are promulgated as “Standards” pursuant to the Soil Erosion and Sediment Control Act of 1975 as amended (N.J.S.A. 4:24-39 et seq.) and New Jersey Administrative Code (N.J.A.C. 2:90-1.1 et seq.).

By the

NEW JERSEY STATE SOIL CONSERVATION COMMITTEE

Douglas H. Fisher, Chairman, Secretary, New Jersey Department of Agriculture

Robert Martin, Commissioner, New Jersey Department of Environmental Protection

Dr. Robert M. Goodman, Exec. Dean, School of Environmental and Biological Sciences, Rutgers University

Dr. Larry Katz, Director, Rutgers Cooperative Extension, Cook College

Carrie Mosley, State Conservationist, USDA Natural Resources Conservation Service

Raymond Cywinski, Supervisor, Bergen County Soil Conservation District

Priscilla Hayes, Supervisor, Mercer County Soil Conservation District

Barbara Rosko, Supervisor, Sussex County Soil Conservation District

Anthony DiLodovico, Supervisor, Ocean County Soil Conservation District

Charles Buscaglia, Supervisor, Freehold Soil Conservation District

Joseph Lomax, Supervisor, Cape-Atlantic Conservation District

John Kocubinski, Governor’s Appointee

Frank Minch, Executive Secretary, State Soil Conservation Committee

FOREWORD AND ACKNOWLEDGMENTS

2014 marks the 38th year of service to New Jersey by the Soil Erosion and Sediment Control Program administered by the Department of Agriculture and the New Jersey Soil Conservation Districts. Since the inception of the idea to apply conservation practices to urban development in 1976, New Jersey has significantly evolved in its approach to erosion control. From simple hay bales for filtering runoff, to advanced computer simulations which model watershed runoff, New Jersey's erosion control practices have taken advantage of developing technologies. Periodically the Department, and Soil Conservation Districts update the "*Standards for Soil Erosion and Sediment Control*" to reflect the ongoing emergence of science and technology.

The *Standards* are a blend of agronomic science and state of the art engineering practices, embodied in 32 individual design chapters and detailed appendices that enable developers to successfully design erosion control practices for construction sites. Soil loss prevention is addressed both during as well as after construction to safeguard New Jersey's natural resources.

Since 1976, more than 920,000 acres of land have been protected from erosion by the application of construction site best management practices to control erosion. This equates to more than 28 million tons of soil that have been prevented from entering the state's waterways. Erosion protection allows for the continuation of recreational opportunities, aids in flood prevention efforts and minimizes the need for water treatment.

The seventh edition of the *Standards* has been revised to include additional guidance for assessing downstream stability, rip rap design, the use of infiltration and additional options for vegetation used in the Pinelands National Reserve. Future revisions are planned to enhance the quality of soil used in establishing vegetation for stabilization of development sites.

The New Jersey Department of Agriculture acknowledges its long-time partners - the United States Department of Agriculture – Natural Resources Conservation Service, the state's 15 Soil Conservation Districts, Rutgers University and the New Jersey Department of Environmental Protection for their assistance in developing these *Standards*. Additionally, the Department appreciates the valued expertise of the New Jersey Pinelands Commission, the New Jersey Department of Transportation and the many representatives of the New Jersey Builders Association and Professional Consulting Engineers who assisted in this project. These partnerships have achieved great success in the minimization of damage due to excessive stormwater runoff and related soil loss from construction sites while at the same time promoting concepts of good stewardship of the state's resources to all of New Jersey's residents.

Douglas H. Fisher
Secretary, New Jersey Department of Agriculture
January 2014

**COMMITTEE FOR REVIEW AND DEVELOPMENT OF
STANDARDS FOR SOIL EROSION
AND
SEDIMENT CONTROL**

January 2014

Mr. William Brash
District Director
Mercer County Soil Conservation District

Mr. Anthony DiLodivico
President
Tony D Environmental Permitting,
LLC

Mr. Steven Jacobus
Watershed Team Leader
Division of Watershed Management N.J.
Department of Environmental Protection

Mr. David Lamm, P.E.
State Conservation Engineer
Natural Resources Conservation Service
U.S. Department of Agriculture

Mr. John Showler, P.E.,
State Erosion Control Engineer
State Soil Conservation Committee
N.J. Department of Agriculture

Mr. Angelo Caruso
District Manager
Bergen County Soil Conservation District

Mr. David Earl, ASLA
Section Chief
Office of Landscape Architecture
NJ Department of Transportation

Mr. Paul Schiariti, P.E.
NPS Coordinator
Mercer County Soil Conservation
District

Mr. Anthony Castillo, P.E.
Principal
SESI Consulting Engineers, Inc.

Mr. Wayne Birchler, P.E.
Former District Engineer
Gloucester County Soil Conservation
District

Mr. Ken Marsh, P.E.
Supervisor (retired)
Somerset-Union Soil Conservation
District

Mr. David Kreck, P.E.
Senior Managing Engineer
Rodriguez Consulting, LLC

Mr. Richard Eigenbrood
Natural Resource Conservationist
(retired)
Gloucester County Soil Conservation
District

Ms. Stephanie Murphy, PhD.
Soil Scientist
Rutgers University

Mr. Ernest Thurlow, PhD.
Manager (retired)
Somerset-Union Soil Conservation
District

Mr. Don Kinesik
President
Pinelands Nursery

Mr. David Friedman
Manager (retired)
Ocean County Soil Conservation
District

Ms. Amy Karpati, PhD
Director for Conservation Science
Pinelands Preservation Alliance

Ms. Valarie Hrable, P.E.
Manager, Hydrology & Hydraulics
Greenman & Pedesen, Inc.

Mr. Robert McCarthy, P.E.
Principle
DW Smith, Inc.

Mr. Brian McClendon
Section Chief
Stormwater Permitting NJDEP

Mr. Ron Bannister
Environmental Specialist
Groundwater NJDEP

Mr. Fred Bowers, PhD
Section Chief (retired)
Groundwater NJDEP

Mr. Barry Chalofsky
Bureau Chief (retired)
Stormwater Permitting, NJDEP

Ms. Robyn Jeney
Regulatory Programs Specialist
New Jersey Pinelands Commission

Developing a Successful Plan to Control Soil Erosion on Construction Sites

“He who fails to plan, plans to fail...” is an oft-quoted proverb. Its original author is unknown, but it is frequently attributed to such famous individuals as Benjamin Franklin, Abraham Lincoln and Winston Churchill. Regardless of who coined the phrase, failure to plan (properly) is never more evident than in a poorly thought out erosion and sediment control plan. Once a slope has eroded, or an infiltration basin has failed, it is too late to ‘plan’. It is only time to react and correct. And usually, it costs more to do something twice, than to do it right the first time.

Though not an exhaustive list, the following represent many of the primary design considerations and constraints in preparing an effective erosion control plan. Effective erosion control should be integrated into planning for stormwater management, and not done as an after-thought. A properly developed plan should address the following aspects of site construction when designing for erosion control:

General Considerations-

1. Design report included and submitted to the district
2. Table of Contents for the design report denoting location of erosion control designs
3. Plan drawn at proper scale (usually not less than 1:50)
4. Erosion Control Plan sheets labeled, signed and sealed by a NJ Licensed Engineer or Architect
5. Pre and post construction contours clearly labeled and depicted
6. Limits of disturbance clearly delineated and corresponding to area of disturbance on the application form
7. Temporary controls such as sediment barriers, inlet filters graphically depicted on plan sheets
8. Details for erosion control applications clearly shown on a ‘detail sheet’; dimensions correspond to design report
9. District notes, vegetative stabilization specifications and other notes shown on the detail page
10. Soil delineations shown on the erosion control plan sheets
11. Other natural features, such as streams, wetlands and buffers delineated on plan sheets
12. Permanent structures graphically depicted on plan sheets (piping, basins, rip rap outlets, swales, basins etc)
13. Offsite improvements (sewer, water, storm drainage, electrical utilities) shown and included in area calculations
14. Proposed staging and stockpile areas depicted (on and off site).

Construction Disturbance Considerations-

1. Phasing of disturbed areas (minimizing open soil areas)
2. Sequence of construction specific to the site (avoid generic sequencing)
3. Stormwater management on a construction site
 - a. Temporary sediment basins with design support and appropriate details
 - b. Diversions & swales
 - c. Grading
 - d. Filtering via pumped discharge
 - e. Dewatering excavations and points of discharge
4. Temporary stabilization with vegetation, mulch, man-made materials etc.
5. Location of temporary controls such as inlet filters, sediment barriers, construction entrances
6. Soil movement – cuts, fills, removal, stockpiles and importation shown on plans
7. Minimization of soil compaction – restrict vehicle travel, avoid working wet soils, restore if needed

Hydrologic Design Considerations-

1. Correct application of hydrologic analysis both onsite and within the local drainage area
 - a. Correct unit hydrograph (i.e., Delmarva for coastal plain areas)
 - b. Pre and post drainage area maps with Tc flow paths and POI’s identified
 - c. Realistic sheet flow length in time of concentration (in all cases, not to exceed 100’)
 - d. Correct pre and post development runoff coefficients
 - e. Influence of geology (esp. limestone prone areas)
 - f. Submission of electronic modeling files to the district
 - g. Submission of Hydrologic Summary forms for each basin
2. Assessment of pre and post development flows for the 2, 10 and 25 (rip rap) year storm events

3. Determination of soil types and their associated limitations (i.e., depth to ground water, slope stability) using the Web Soil Survey (<http://websoilsurvey.nrcs.usda.gov/app/HomePage.htm>)
4. Final points of discharge from the site and stability at those locations
5. Discharging to agricultural fields (generally not permitted due to stability concerns)
6. Infiltration and failure analysis for stability
7. Impact of discharge beyond the limits of the project (off site stability)
8. Stability of slopes – both from overland flow as well as impacts due to infiltration saturation
9. Proper use of permanent vegetative cover – species selection, irrigation, soil quality, maintenance
10. Use of turf reinforcement matting on steep slopes or channel lining
11. Rock rip rap sizing, gradation and availability; alternate use of gabions or reinforced concrete
12. Grass water way designs using vegetative retardance (D & E) factors, soil conditions, velocity, proper vegetation and reinforcement mating

Requirements of Other Agencies-

1. NJ Department of Environmental Protection-
 - a. Stormwater Rules
 - b. Wetlands
 - c. Highlands
 - d. Stream Encroachment
2. Residential Site Improvement Standards
3. NJ Department of Transportation
4. NJ Pinelands Commission
5. County and municipal construction codes

When preparing an erosion control plan, one resource which should not be overlooked is New Jersey's 15 Soil Conservation Districts. With a broad spectrum of expertise in the areas of erosion and sediment control, agronomy, horticulture and stormwater management, District staff are available to assist designers with development of reliable and effective strategies for controlling erosion from construction sites. A list of New Jersey Soil Conservation District contact information is found in Appendix E of the Standards.

Procedure for the evaluation of new erosion control technologies, products and services for compliance with the Standards for Soil Erosion and Sediment Control in New Jersey

In order to address opportunities to utilize new and innovative technologies, products and services (TPS) for sediment and erosion control, the New Jersey Department of Agriculture, State Soil Conservation Committee (SSCC) has adopted the following evaluation process which is intended to provide compliance with the Standards.

The Standards include, where appropriate and necessary, design and performance specifications so that any TPS which meets these specifications would be acceptable for use on construction sites in New Jersey for compliance with the Act without the need for extensive (and expensive) laboratory testing. A new TPS which differs from design or performance standards, or which attempts to define a non-standardized practice must be field tested in New Jersey prior to acceptance.¹

Field performance will be monitored by Soil Conservation District personnel as well as the NJDA State Erosion Control Engineer (as needed). The process for TPS field evaluation is as follows:

1. The vendor will provide a written request for evaluation to the State Engineer and the local Soil Conservation District where the product is to be evaluated. The request must include a physical/chemical description of the product, design limitations (if any), what function the product is intended to perform, and which Standard it is to be used in compliance for. Laboratory or other supplier-derived test data may also be submitted if desired.
2. The State Engineer will review the request and consult with the respective district or districts to verify that the TPS being proposed is appropriate for the intended application and site location. Alternative locations may be suggested if the proposed location is not deemed adequate for a complete evaluation. Written permission and agreement for allowing the evaluation must be secured from the site owner and is the responsibility of the vendor, with a copy provided to the district and State Engineer.² The State Engineer can provide written confirmation to the site owner that for testing and evaluation purposes, the owner is assisting the State in its evaluation of a new product and will not be liable for a lack of erosion control compliance with their certified plan due to product failure as long as the product is properly installed and is provided with the appropriate routine maintenance, as would be the case for the use of any erosion control product.
3. The State Engineer will advise the SSCC and other districts of the request for testing at the next SSCC meeting.
4. Once a proper location is secured, the vendor will oversee and provide training (if necessary) for proper installation of the product to ensure an adequate evaluation is performed. During the evaluation, District staff and/or the State Engineer will monitor and observe the performance of the TPS and maintain observations in project record notes as part of routine inspections. The TPS must be properly installed and in good working order during a test event to be considered as a viable test. Unintentional damage or improper installation and subsequent failure will not count as a viable test. The State Engineer may consult with other experts, as needed, to ensure comprehensive evaluation. The vendor will be notified if any product failure or damage occurs so that corrective action may be taken, if appropriate, to restore proper functioning of the TPS.
5. TPS's which are intended to secure against erosion by resisting the forces of water and/or wind will be evaluated for 3 discrete events, each of which must meet the minimum event criteria (such as minimum precipitation depth, flow rate, velocity, etc.) prescribed by the vendor or as stipulated in the applicable Standard. For TPS's intending to promote or enhance vegetative stabilization an evaluation period of two consecutive growing seasons will be observed to determine product performance.
6. The State Engineer will review notes, photos, etc. and present findings and conclusions to the SSCC with recommendations. These recommendations may be:
 - (1) the TPS is acceptable for use anywhere in NJ;
 - (2) the TPS is acceptable for use only in particular locations in NJ

¹ Not every Standard is based on design and/or performance criteria. Certain Standards require computation or specific materials in their application for compliance.

² Neither the Soil Conservation District nor the State Engineer may compel a project owner to allow the use of a new product for testing on his or her site. Assistance is strictly voluntary on the part of the owner.

- (3) the TPS is acceptable for use only for particular site and/or weather conditions
- (4) the TPS is not acceptable for use in NJ.

The SSCC may, at its pleasure and discretion, accept, accept with modifications or reject the recommendations.

- 7. A TPS that is found to be acceptable for use in NJ (with or without conditions) will be identified in a TPS Bulletin (PSB) to be maintained and published by NJDA-SSCC. Conditions or limitations of the TPS will be identified in the bulletin, which will be published on the Department's website and will be available for public download. The vendor will be provided a copy of the findings and conclusions along with a copy of a TPS Bulletin, if one is issued.
- 8. Once a TPS Bulletin is issued, no further written approval or requests for use will be required for inclusion on soil erosion and sediment control plans or as an equivalent substitute to controls that are already shown on a plan. All manufacturer installation details, maintenance requirements and limitations must be included on the plan adjacent to the installation details.

Compliance with the Standards is required by N.J.S.A. 4:24-39 et seq. for all construction sites in New Jersey which meet the definition of a soil disturbance 'project' as defined in the Act. As a result, the specific inclusion of proprietary, manufactured products, product names, technologies or services is prohibited in that this may constitute the endorsement of one product over another by the State. Generic products which have historically been used for controlling erosion and are considered to be in the public domain may be generically referenced in the Standards without the use of trade-marked TM names.

State Soil Conservation Committee

Standards For Soil Erosion and Sediment Control in New Jersey

Table of Contents

2014 State Soil Conservation Committee Members.....	i
Forward and Acknowledgements.....	ii
Committee for Review and Development of Standards.....	iii
Developing a Successful Erosion Control Plan.....	iv
Accommodation of New Erosion Control Products.....	v
Table of Contents.....	vi

Vegetative Standards

Acid Soils Management.....	1-1
Dune Stabilization.....	2-1
Maintaining Vegetation	3-1
Permanent Vegetative Cover for Soil Stabilization	4-1
Stabilization with Mulch Only.....	5-1
Stabilization with Sod	6-1
Temporary Vegetative cover for Soil Stabilization.....	7-1
Topsoiling (revised July 2017).....	8-1
Tree Protection During Construction	9-1
Trees, Shrubs and Vines	10-1

Engineering Standards

Channel Stabilization.....	11-1
Conduit Outlet Protection	12-1
Detention Structures.....	13-1
Dewatering.....	14-1
Diversions	15-1
Dust Control.....	16-1
Grade Stabilization Structure	17-1
Grassed Waterway	18-1
Land Grading (revised July 2017)	19-1

Lined Waterway	20-1
Off-Site Stability analysis	21-1
Riprap	22-1
Sediment Barrier	23-1
Sediment Basin	24-1
Slope Protection Structures	25-1
Soil Bioengineering	26-1
Stabilized Construction Access.....	27-1
Storm Sewer Inlet Protection	28-1
Stream Crossing	29-1
Subsurface Drainage	30-1
Traffic Control	31-1
Turbidity Barrier	32-1

Appendices

The Universal Soil Loss Equation.....	A1-1
Application Requirements, Forms & Addendum for Reporting Corporate Ownership	A2-1
Guide for Construction Specifications	A3-1
Maintenance of Structural Measures.....	A4-1
Guide for Installing Soil Stabilization Matting	A5-1
Diversion and Grass Waterway Design Procedure	A6-1
Sediment Basin Design Procedure	A7-1
Channel Stability Analysis Procedure.....	A8-1
Modified Rational Method.....	A9-1
Structural Guidelines for Detention Basins	A10-1
References.....	A11-1
Guidelines for Plan Review (reserved).....	A12-1
Anderson Land Use Code for Detention Basin Summary Form.....	A13-1
Example Seed Specifications and Grass - Legume - Shrub Planting Guide	B-1
Soil Erosion and Sediment Control Act.....	C1-1
New Jersey Administrative Code 2:90-1.1 et seq.	C2-1

Chronology of the “Standards for Soil Erosion and Sediment Control in New Jersey”C3-1

Glossary of Terms D1-1

Directory of Soil Conservation Districts in New JerseyE1-1

Treatment of Limestone Areas.....K-1

**STANDARD
FOR
MANAGEMENT OF HIGH ACID-PRODUCING SOILS**

Definition

High acid-producing soils are soils with a pH of 4.0 or less or contain iron sulfide.

Purpose

To prevent or limit exposure area, time, and spreading by equipment or rainfall on- and off-site and to minimize erosion, sedimentation and acid leachate-related damages. High acid-producing soil may be exposed during excavation and land grading activities, or may be introduced in dredged sediment. Soils and sediment containing iron sulfide, characterized by pyrite or marcasite nuggets or greensands, are chemically oxidized when exposed to air, producing sulfuric acid and result in soil pH levels falling to pH 4.0 and lower. Most vegetation is incapable of growth at this pH level. Adjacent land and receiving waters will be negatively impacted by the acid leachate. Calcium-containing materials such as sidewalks, culverts and other structures and some metallic materials are also susceptible to degradation. Agricultural limestone materials applied at rates of 8 tons per acre have resulted in only a temporary buffering effect, and “liming-only” is therefore not considered an acceptable mitigation practice.

Water Quality Enhancement

Protects onsite soils and offsite streams and lakes from sulfuric acid leachate that creates soil pH conditions unsuitable for growth of vegetation.

Where Applicable

This practice is applicable to any high acid-producing soil materials. Such materials have been found in the Coastal Plain areas of Burlington, Camden, Cumberland, Gloucester, Mercer, Middlesex, Monmouth, Ocean, Salem and Somerset Counties.

Planning Criteria

Early recognition and burial, removal or disposal of high acid-producing soils is essential for limiting the amount of acidic material produced.

Review a surface geology map for the proposed site to investigate the presence of geologic formations which commonly contain high acid-producing deposits. The geologic formations are as follows:

Cheesequake	Manasquan	Red Bank, Sandy Hook Member
Englishtown Sand	Marshalltown	Shark River
Hornerstown	Merchantville	Tinton
Kirkwood	Navesink	Wenonah
Magothy	Raritan	Woodbury Clay

Figure 1-1 shows areas where these deposits may be present.

Contact the local Soil Conservation District to determine the historical presence of high acid-producing soils in the vicinity of the proposed development site.

High acid-producing soils may be present in undisturbed soils at varying depths, including near the soil surface to excavations or deep disturbances. Its presence on a site may be significant or limited in the soil profile. High acid-

producing soils are commonly black, dark brown, gray or greenish with silvery pyrite or marcasite nuggets or flakes. Alternatively, sandy soils or reddish, yellowish or light to medium brown soil materials are usually free of high acid-producing deposits.

Methods and Materials

1. Limit the excavation area and exposure time when high acid-producing soils are encountered.
2. Topsoil stripped from the site shall be stored separately from temporarily stockpiled high acid-producing soils.
3. Stockpiles of high acid-producing soil should be located on level land to minimize its movement, especially when this material has a high clay content.
4. Temporarily stockpiled high acid-producing soil material to be stored more than 48 hours should be covered with properly anchored, heavy grade sheets of polyethylene where possible. If not possible, stockpiles shall be covered with a minimum of 3 to 6 inches of wood chips to minimize erosion of the stockpile. Silt fence shall be installed at the toe of the slope to contain movement of the stockpiled material. Topsoil shall not be applied to the stockpiles to prevent topsoil contamination with high acid-producing soil.
5. High acid-producing soils with a pH of 4.0 or less or containing iron sulfide (including borrow from cuts or dredged sediment) shall be ultimately placed or buried with limestone applied at the rate of 10 tons per acre (or 450 pounds per 1,000 square feet of surface area) and covered with a minimum of 12 inches of settled soil with a pH of 5.0 or more except as follows:
 - a. Areas where trees or shrubs are to be planted shall be covered with a minimum of 24 inches of soil with a pH or 5 or more.
 - b. Disposal areas shall not be located within 24 inches of any surface of a slope or bank, such as berms, stream banks, ditches, and others, to prevent potential lateral leaching damages.
6. Equipment used for movement of high acid-producing soils should be cleaned at the end of each day to prevent spreading of high acid-producing soil materials to other parts of the site, into streams or stormwater conveyances, and to protect machinery from accelerated rusting.
7. Non-vegetative erosion control practices (stone tracking pads, strategically placed limestone check dam, sediment barrier, wood chips) should be installed to limit the movement of high acid-producing soils from, around, or off the site.
8. Following burial or removal of high acid-producing soil, topsoiling and seeding of the site (see Temporary Vegetative Cover for Soil Stabilization, Permanent Vegetative Cover for Soil Stabilization, and Topsoiling), **monitoring must continue for a minimum of 6 months** to ensure there is adequate stabilization and that no high acid-producing soil problems emerge. If problems still exist, the affected area must be treated as indicated above to correct the problem.

Figure 1-1. NJ sedimentary units with potential to produce acid:

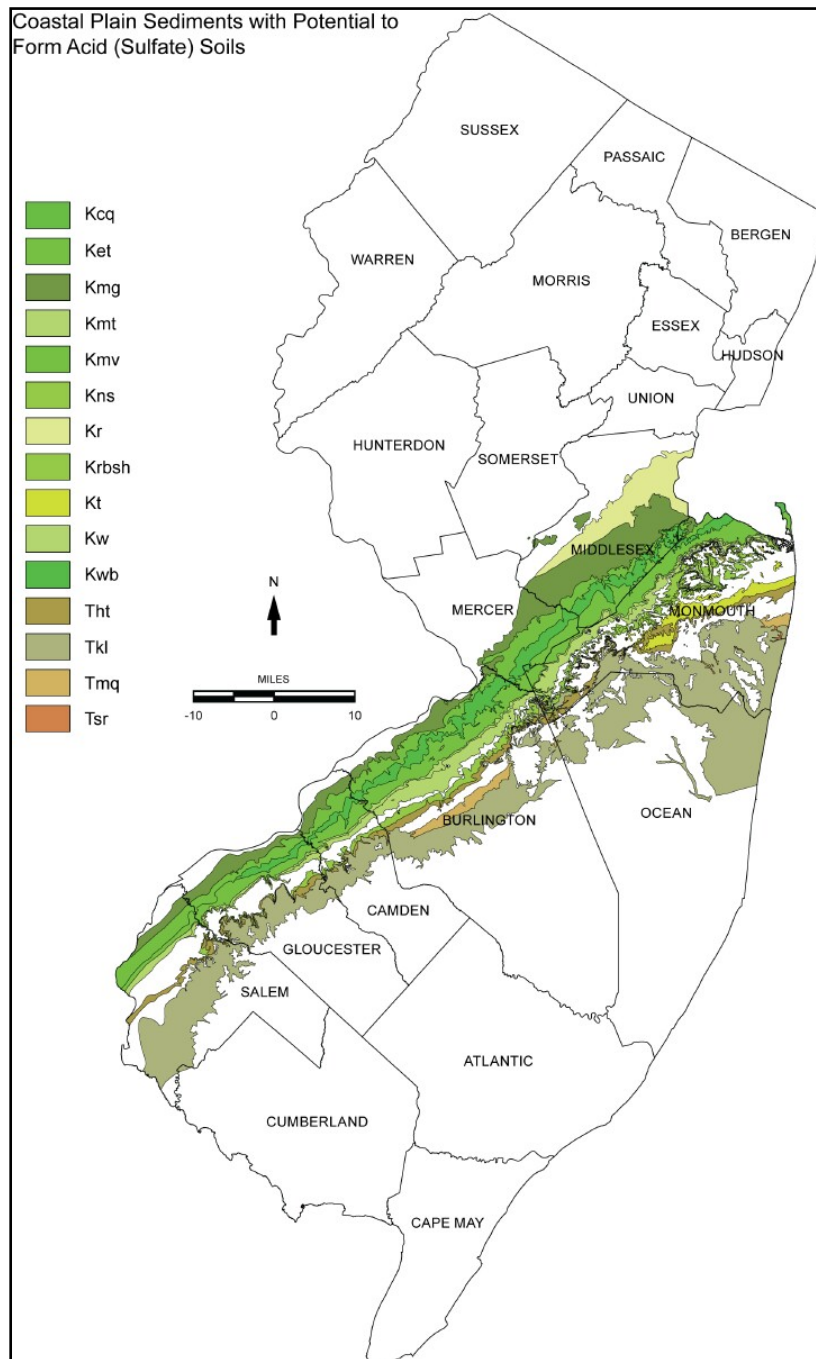

Tkl=Kirkwood, Tsr=Shark River, Tmq=Manasquan, Tht=Hornerstown, Kt=Tinton, Krbsh=Sandy Hook Member of the Red Bank, Kns=Navesink, K2=Wenonah, Kmt=Marshalltown, Ket=Englishtown, Kwb=Woodbury, Kmv=Merchantville, Kcq=Cheesequake, Kmg=Magothy, and Kr=Raritan Formations. Credit: NJ Geological Survey, <http://www.state.nj.us/dep/njgs/geodata/dgs09-2.htm>

**STANDARD
FOR
DUNE STABILIZATION**

Definition

Controlling surface movement of sand dunes or shifting sand by vegetative or mechanical means.

Purpose

To reduce wind erosion and the encroachment of shifting sands, to provide a barrier against tide water, and to make the areas useful for other purposes.

Water Quality Enhancement

Reduces wind erosion, sand movement by storms and tides and facilitates dune building at ocean, bay frontal and back bay areas.

Where Applicable

Along ocean and bay shorelines where blowing sands and storm waters may cause erosion damage. Stay at least one hundred feet (horizontal distance) from mean high tide water line (MHT).

Methods and Materials

Sand dunes naturally form on barrier islands, shorelines exposed directly to the ocean, and inland sand deposits. The source of this wind born sand is the ocean or its bays. These parallel ridges of sand form perpendicular to prevailing winds and grow toward its source of sand. Periodic storm events and human activity continually alter their development and original configuration. Once developed the sand dunes provide protection from moderate storms and tides. The existence and maintenance of vegetation on dunes provides a network of root and foliage which holds unconsolidated sand in place. American beachgrass is the dominant, naturally occurring, vegetation of the frontal dunes of New Jersey. When beachgrass is established with structural resources and other dune species, a formidable well anchored storm barrier is established.

1. VEGETATION

- A. Materials: The foliage of most sand dune species filters sand from the wind. The reduction of wind velocity near the dune's surface by vegetation allows sand to be deposited. The root mass of these plant species of the sand dunes are typically deep and extensive, anchoring the dunes to their foundation. When possible certified cultivars, which have been tested on similar sites, should be utilized.
- B.
 - 1. To promote biodiversity species planting is preferred however, cultivar releases recommended for NJ sand dunes; all listed were released by the USDA, Natural Resources Conservation Service Cape May Plant Material Center, located in Swainton, NJ. a.
 - 'Cape` **American Beachgrass** (*Ammophila breviligulata*)
 - b. 'Atlantic` **Coastal Panicgrass** (*Panicum amarum* var. *amarulum*)
 - c. 'Avalon` **Saltmeadow Cordgrass** (*Spartina patens*)
 - d. 'Wildwood` **Bayberry** (*Myrica pensylvanica*)
 - e. 'Ocean View` **Beach Plum** (*Prunus maritima*)

2. Non-Cultivar releases suitable for NJ sand dunes
 - a. **Switchgrass** (*Panicum virgatum*)
 - b. **Bitter Panicgrass** (*Panicum amarum*)
 - c. **Seashore Little Bluestem** (*Schizachyrium scoparium* var. *litoris*)
 - d. **Seaside Goldenrod** (*Solidago sempervirens*)
 - e. **Eastern Red Cedar** (*Juniperus virginiana*)
- C. Establishment: Online information concerning dune stabilization may be found at the uSDA-NRCS Plant Materials Center (PMC) website: <http://plant-materials.nrcs.usda.gov/njpmc/>

1. American Beachgrass - Beachgrass is successional classified as a pioneering type species; it is the hardest species **capable of surviving the harsh environmental conditions of the frontal dunes**. For initially stabilizing a dune system, this species is the most reliable and commercially available option. Once established it rapidly spreads by a rhizomatous root system, developing a soil binding network of inter-woven roots.

Planting Dates: October 15 to April 1; under non frozen soil conditions

Planting Unit: a minimum of two stems (culms) per hole

Method: hand placement, or use of a vegetable or tree planter

Size: 16 to 18 inch long stems, > ¼ inch in diameter

Depth: approximately 8 inches deep (≥ 7" but ≤ 9" is acceptable)

Spacing :

severe sites =	12" X 12"
normal sites =	18" X 18"
stable sites =	24" X 24"

Notes:

- Plant ≥ 100 feet of horizontal distance from the mean high tide water line to ensure success
 - Plant a minimum of 10 parallel rows; stagger (off-set) rows to maximize protection
 - Firm soil around plants to eliminate air pockets
 - If utilizing dredged fill allow salts to leach out before planting and allow rains to compact sands.
2. Coastal Panicgrass - This warm season bunch-like grass is a post stabilization species **thriving from the crest of the frontal dune to inland sites**. It is the only dune stabilization species which has been directly seeded on to the sand dunes successfully. Potted plants and stem divisions can also be successfully established on these severe sites. The annual foliage emerges from a deep fibrous perennial root system with short lateral rhizomes. This species can be successfully planted with or over seeded into stands of American beachgrass. The same plant and seed establishment techniques outlined below, also pertain to Switchgrass, Seashore Little Bluestem, and Seaside Goldenrod.

Seeding Dates: over seeding: April 1 to May 1
 dormant seeding: November 1 to April 15
 planting plugs or transplants: April 1 to May 15

Planting Unit: single bare-root or containerized seedling or division; 12 - 18 inches tall

Seeding rate: 8 to 12 Lbs. of Pure Live Seed (PLS) per acre

Depth: plants: 2 inches deeper than the nursery depth

seed: drilled 1½ to 2½ inches deep

Method plants: hand placed, or use a vegetable or tree planter
seed: hand or mechanically operated drill or seeder

Spacing: plants: 4' X 4'
seed: 3' to 10' row spacing

- 3) Saltmeadow Cordgrass - Although typically associated with tidal salt marshes, this cordgrass also naturally occurs in the **secondary and back dune areas**, predominantly inhabiting inter-dune troughs and low blow-out areas. It is dominate in these micro-sites since most other sand dune species can not tolerate wet to saturated soil conditions. The trailing rhizomes of saltmeadow cordgrass are slender, but form dense mats near the surface. It is vegetatively established on normal sites using freshly harvested stems (culms) or containerized plants on severe locations.

Planting Date: May 1 to June 15

Planting Unit: 3 to 5 live stems placed bare-root or containerized

Depth: 2 inches below the nursery grown depth

Method: hand placed, or vegetable planter

Size: > 12 inches

Spacing: 18 to 36 inches depending on the severity of the planting site

Note: Utilize this species in low elevation sites of sand dunes which are frequently inundated.

4. Shrubs and Trees - Medium sized shrubs and small trees naturally **dominate the back dune** zone of New Jersey's barrier islands. The shrubs begin to **co-inhabit the mid secondary dunes**. Once extensive stands of bayberry, beach plum, pitch pine and other woody species covered these islands where houses now stand. The shrub species which are well adapted to the dune ecosystem are capable of either layering or root suckering.

The trees and shrubs of the sand dunes have deep tap root systems for supplying adequate moisture and nutrients. Each species utilized for back dune stabilization has its own unique attributes. **Beach plum** has a colorful bloom in spring which yields a tasty succulent cherry like fruit. **Bayberry** roots have nodules which enable it to fix atmospheric nitrogen similar to legumes; it also produces aromatic fruit and leaves. The **junipers** which are adapted to sand dunes provide the visual appeal of evergreens in the back dunes.

The major function of tree and shrub vegetation on sand dunes is still the permanent solid structural stabilization. All of trees and shrubs of the sand dunes produce viable seed, but intentional establishment occurs using bare-rooted or potted seedlings.

Planting Date: March 15 to April 15; unless soil is frozen

Planting Unit: 1/0 or 2/0 bare-root seedlings or containerized transplants

Depth: 2 inches below the nursery grown depth

Method: hand placement or using a tree planter

- Size: > 12 inches tall
- Spacing: 4 to 6 feet apart; off-set (stagger) rows for maximum protection
- Note: to ensure establishment (first 2 years) all competing vegetation must be removed from within 2 feet of each plant; it is important not fertilize the surrounding vegetation which will potentially out-compete the tree or shrub

C. Maintenance

1. Fertilizer

- Date: May through July; no sooner than 30 days after planting
- Rate: \leq 50 lbs. of nitrogen (N) per acre < 25 lbs. of phosphorus (P) and 25 lbs. potassium (K) per acre
- Frequency:

- Apply N for the first two years after planting, then as needed to maintain stem density and plant health.
- Single or split applications are acceptable if not applied before May 1 or after July 30. Split applications must be at least 30 days apart.
- It is only necessary to apply (P) and (K) in alternate years.

Recommended Formulations:

- 10-10-10, 20-10-10, 15-10-10, etc. are acceptable as long as the maximum rates per nutrient are not exceeded.
- Time release fertilizers are encouraged that will provide the target amounts of the primary nutrients per acre.

Notes: Fertilize dune grass planting by mechanical or broadcast application, except where woody species are planted. Only apply fertilizer within the drip line of shrubs and trees. Not following this procedure will result in excessive herbaceous growth, which will out compete newly established trees and shrubs. Where woody plants are established, fertilizer may be broadcast applied.

2. Replanting

- Like a chain, a dune system is no stronger than its weakest link. Uniform, unbroken dune lines are essential to the protection a system can provide.
- Uncontrollable events (i.e. Storms, construction, etc.) may damage sand dunes. If such damage occurs between October and April replant within a month. If the damage is experienced from May to September, utilize the outlined sand fencing or excavation procedures listed below, then plant during the recommended establishment period.

D. Dune Crossing Areas

Where foot or vehicular traffic is expected over dunes, it is recommended a curvilinear path be constructed to direct traffic. These paths can be constructed with boards or be of a gravel

base and should be bordered by sand fence to funnel the traffic to and from the beach.

2. SANDFENCING:

A quick and effective way to build temporary sand dunes is with the use of sand fencing (standard snow fence). Utilizing lines of fencing and wooden posts, orientated parallel to the beach approximately 140 feet (horizontal distance) from mean high tide. A source of sand is necessary for this technique to be effective, but it is not limited by time of establishment.

A. Materials

1. Fencing

- Standard 4 ft. slatted wood snow fencing; wood must be decay free.
- Polyvinyl fencing material with 50% porosity may be used as an alternative.
- Four wire ties (> 12 ga.) must be used to secure fencing to each post.

2. Posts

- Wooden posts must be > 6½ ft. long, with a minimum diameter of 3 inches; typical length ranges from 7 to 8 ft.
- The posts should be made from black locust, eastern red cedar, Atlantic white cedar, or other species of similar durability and strength.
- Space posts 10 ft. apart, and set them > 3 feet deep.

B. Technique

1. Position - orientation of fence line is parallel to waterline of the beach, at least 140 feet (horizontal distance) from mean high tide (see figure 2).
2. Height - with adequate sand sources, dune elevations can be increased annually by at least four foot increments (approximately the maximum height of the fencing, this can be increased with vegetation). The maximum dune height which is attainable will range from 12 to 15 feet, but is greatly influenced by prevailing wind velocities and sand grain size.
3. Installation - weave fencing in front of and behind alternating posts to attain maximum strength.
4. Number of Rows - When the distance to the MHT water line is 100 feet or more, 2 parallel rows spaced 30 to 40 feet apart are ideal; but single rows with 30 foot perpendicular spurs, spaced 40 feet apart are also acceptable if there is less than 100 feet from the MHT and a protective dune is desired. A zigzag pattern may also be considered. Where there is less than 50 feet from the MHT it may not be feasible to build dunes.
5. Replacement - sand will typically fill fencing to ¾ of its total height at a maximum; upon reaching maximum fence capacity, additional lines of fence can be added until maximum planned dune height is reached; replace damaged fencing and posts within one month of storm damage to maintain a contiguous dune line.

C. Comments

1. This method is more expensive per lineal foot than building dunes with vegetation

alone, but less expensive than using earth moving machinery to construct dunes.

2. Although dune height can be increased faster, it is limited by the fence height and ability to continually add more lines of fencing.
3. Planting parallel rows of vegetation on either side of fences is usually more effective than either vegetation or fencing techniques alone.
4. When complementing fencing with vegetation, do not plant closer than ten feet and no further than 15 feet from the fence lines. Vegetative strips should be about 20 feet wide (see figure 2-2 & 2-3).

3. MECHANICAL EXCAVATION

- A. With the use of various earth moving machines temporary, excavated sand dunes are quickly created.
- B. Since time is required for settling and cohesion to occur, such dunes are often short lived and only provide minimal protection to the public and private resources behind them.
- C. This method is often useful in the repair of storm damaged sand dunes during the fall and winter months. Any blow-out areas can be quickly filled.
- D. Front-end loaders of all sizes can be used. Various grading machines are also useful.
- E. Pumped sand from off shore dredging can be shaped and positioned with machinery.

Figure 2-1

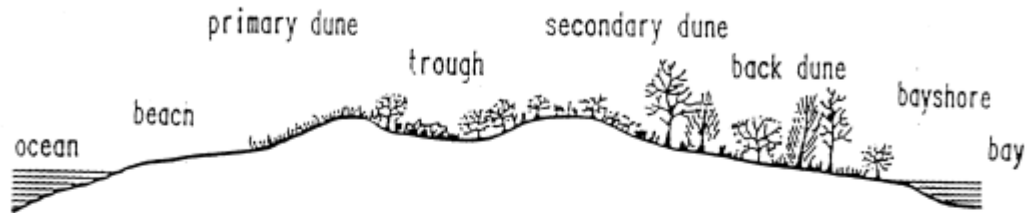

TYPICAL BARRIER ISLAND CROSS SECTION.

Figure 2-2

COMBINATION OF SAND FENCE AND VEGETATION FOR DUNE BUILDING

not to scale

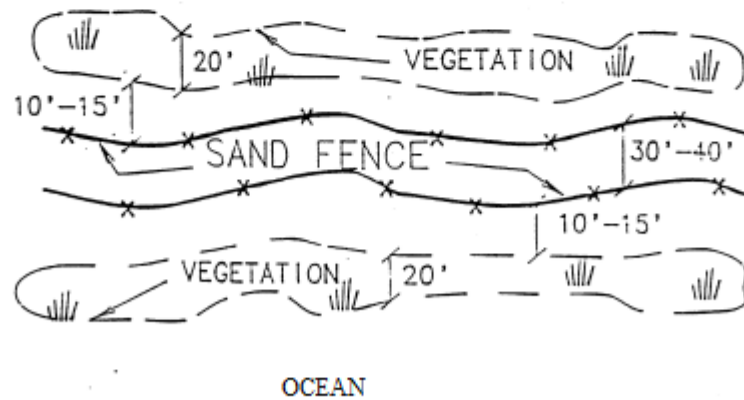

Source: USDA

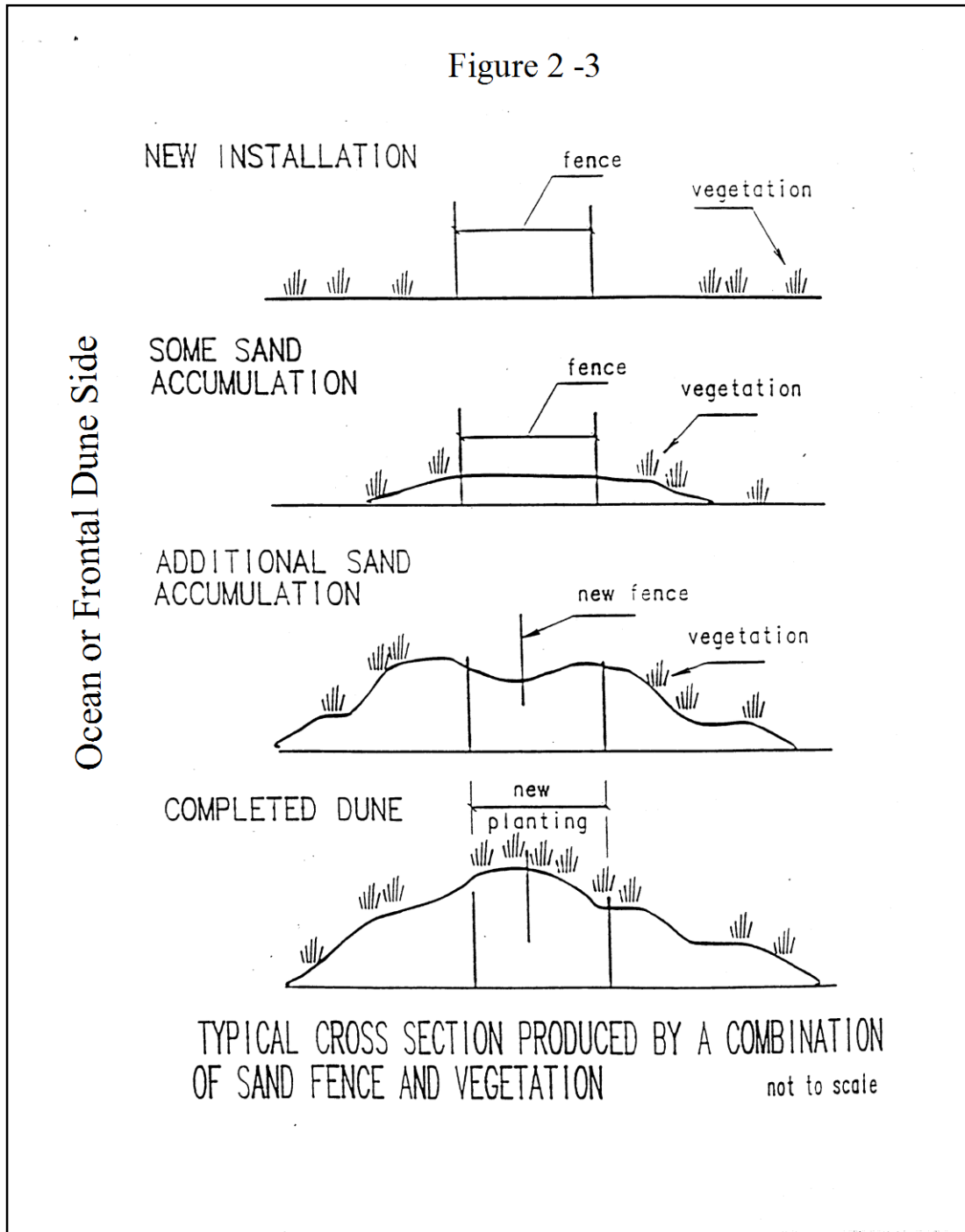

Source: USDA

STANDARD
FOR
MAINTAINING VEGETATION

Definition

The perpetuation of vegetative cover.

Purpose

To ensure the continuing vigor and function of vegetative cover and enhance the environment. It is usually less costly to carry on a maintenance program than it is to make repairs after an extended period of neglect.

Water Quality Enhancement

Ensures adequate permanent cover and prevents exposure of soils to erosion and off site sedimentation from stormwater runoff impacts.

Where Applicable

On areas where existing vegetation protects or enhances the environment.

Methods and Materials

A preventive maintenance program anticipates requirements and accomplishes work when it can be done with least effort and expense to insure adequate vegetative cover.

Maintenance should occur on a regular basis, consistent with favorable plant growth, soil, and climatic conditions. This involves regular seasonal work for mowing, fertilizing, liming, watering, pruning, fire control, weed and pest control, reseeding, and timely repairs.

The degree of preventive maintenance needed depends upon the type of vegetation and its proposed function or use.

1. Mowing is a recurring practice and its intensity depends upon the function of the ground cover. On high to moderate (A to B) maintenance areas, such as lawns, certain recreation fields, and picnic areas, mowing will be frequent (2 to 7 day intervals) and typically at a height of 2.5 to 3 inches. Return clippings from mowing (mulching mower) to the turf to reduce the amount of fertilizer needed to maintain the turf by as much as 50%. Some turf mixtures can be managed as naturalized stands requiring only one (cool season mixtures) or two (warm season mixtures) mowings per year. Mowing of naturalized areas is typically done at heights no less than 4 inches and should not be done between April 1st and July 15th to avoid disturbing ground nesting birds. The large amount of clipping debris generated by mowing naturalized areas will need to be removed and/or dispersed so the vegetation is not smothered. Burning of naturalized areas is another procedure used to manage naturalized turfs. Low maintenance (D) areas may be left unmowed to permit natural succession. See pg. 4-13 footnote #4, Maintenance Levels A, B, C and D in the Standard for Permanent Vegetative Cover, Table 4-3.
2. Incorporation of organic matter (for example, mature compost) into the soil will substantially reduce the need for fertilizer and irrigation inputs.
3. Fertilizer and lime should be applied as needed to maintain a dense stand of desirable species. Frequently mowed areas and those on sandy soils will require more frequent fertilization but at lower nutrient rates per application.

4. Lime requirement should be determined by soil testing every 2 or 3 years. Fertilization may increase the need for liming. Contact the local county extension office for details on soil testing and fertilization and pest control recommendations online at <http://njaes.rutgers.edu/county/>.
5. Fertilization and additions of other soil amendments are not recommended for managing native vegetation such as in the Pinelands National Reserve. See the Standard for Permanent Vegetative Stabilization for specific requirements in the PNR.
6. Weed invasion may result from abusive mowing and from inadequate fertilizing and liming. Many newly established grasses will not survive if mowed at heights below 2.5 inches and at intervals greater than 7 days. Brush invasion is a common consequence of lack of mowing. The amount of weeds or brush that can be tolerated in any vegetated area depends upon the intended use of the land. Drainage ways are subject to rapid infestation by weed and woody plants. These should be controlled, since they often reduce drainage way efficiency. Control of weeds or brush is accomplished by using herbicides or mechanical methods.
7. Fire hazard is greater where dry vegetation has accumulated. The taller the vegetation, the greater the hazard.
8. Prune trees and shrubs to remove dead or damaged branches. Remove undesirable or invasive plants to maintain integrity of the landscape and enhance quality of permanent vegetative cover.

**STANDARD
FOR
PERMANENT VEGETATIVE COVER FOR SOIL STABILIZATION**

Definition

Establishment of permanent vegetative cover on exposed soils where perennial vegetation is needed for long-term protection.

Purpose

To permanently stabilize the soil, ensuring conservation of soil and water, and to enhance the environment.

Water Quality Enhancement

Slows the over-land movement of stormwater runoff, increases infiltration and retains soil and nutrients on site, protecting streams or other stormwater conveyances.

Where Applicable

On exposed soils that have a potential for causing off-site environmental damage.

Methods and Materials

1. Site Preparation

- A. Grade as needed and feasible to permit the use of conventional equipment for seedbed preparation, seeding, mulch application, and mulch anchoring. All grading should be done in accordance with Standard for Land Grading.
- B. Immediately prior to seeding and topsoil application, the subsoil shall be evaluated for compaction in accordance with the Standard for Land Grading .
- C. Topsoil should be handled only when it is dry enough to work without damaging the soil structure. A uniform application to a depth of 5 inches (unsettled) is required on all sites. Topsoil shall be amended with organic matter, as needed, in accordance with the Standard for Topsoiling.
- D. Install needed erosion control practices or facilities such as diversions, grade-stabilization structures, channel stabilization measures, sediment basins, and waterways.

2. Seedbed Preparation

- A. Uniformly apply ground limestone and fertilizer to topsoil which has been spread and firmed, according to soil test recommendations such as offered by Rutgers Co-operative Extension Soil sample mailers are available from the local Rutgers Cooperative Extension offices (<http://njaes.rutgers.edu/county/>). Fertilizer shall be applied at the rate of 500 pounds per acre or 11 pounds per 1,000 square feet of 10-10-10 or equivalent with 50% water insoluble nitrogen unless a soil test indicates otherwise and incorporated into the surface 4 inches. If fertilizer is not incorporated, apply one-half the rate described above during seedbed preparation and repeat another one-half rate application of the same fertilizer within 3 to 5 weeks after seeding.

- B. Work lime and fertilizer into the topsoil as nearly as practical to a depth of 4 inches with

a disc, spring-tooth harrow, or other suitable equipment. The final harrowing or disking operation should be on the general contour. Continue tillage until a reasonable uniform seedbed is prepared.

- C. High acid producing soil. Soils having a pH of 4 or less or containing iron sulfide shall be covered with a minimum of 12 inches of soil having a pH of 5 or more before initiating seedbed preparation. See Standard for Management of High Acid-Producing Soils for specific requirements.

3. Seeding

- A. Select a mixture from Table 4-3 or use a mixture recommended by Rutgers Cooperative Extension or Natural Resources Conservation Service which is approved by the Soil Conservation District. Seed germination shall have been tested within 12 months of the planting date. No seed shall be accepted with a germination test date more than 12 months old unless retested.
1. Seeding rates specified are required when a report of compliance is requested prior to actual establishment of permanent vegetation. Up to 50% reduction in rates may be used when permanent vegetation is established prior to a report of compliance inspection. These rates apply to all methods of seeding. Establishing permanent vegetation means 80% vegetative coverage with the specified seed mixture for the seeded area and mowed once.
 2. Warm-season mixtures are grasses and legumes which maximize growth at high temperatures, generally 85° F and above. See Table 4-3 mixtures 1 to 7. Planting rates for warm-season grasses shall be the amount of Pure Live Seed (PLS) as determined by germination testing results.
 3. Cool-season mixtures are grasses and legumes which maximize growth at temperatures below 85°F. Many grasses become active at 65°F. See Table 4-3, mixtures 8-20. Adjustment of planting rates to compensate for the amount of PLS is not required for cool season grasses.
- B. **Conventional Seeding** is performed by applying seed uniformly by hand, cyclone (centrifugal) seeder, drop seeder, drill or cultipacker seeder. Except for drilled, hydroseeded or cultipacked seedings, seed shall be incorporated into the soil within 24 hours of seedbed preparation to a depth of 1/4 to 1/2 inch, by raking or dragging. Depth of seed placement may be 1/4 inch deeper on coarse-textured soil.
- C. After seeding, firming the soil with a corrugated roller will assure good seed-to-soil contact, restore capillarity, and improve seedling emergence. This is the preferred method. When performed on the contour, sheet erosion will be minimized and water conservation on site will be maximized.
- D. **Hydroseeding** is a broadcast seeding method usually involving a truck, or trailer-mounted tank, with an agitation system and hydraulic pump for mixing seed, water and fertilizer and spraying the mix onto the prepared seedbed. **Mulch shall not be included in the tank with seed.** Short-fibered mulch may be applied with a hydroseeder following seeding. (also see Section 4-Mulching below). Hydroseeding is not a preferred seeding method because seed and fertilizer are applied to the surface and not incorporated into the soil. When poor seed to soil contact occurs, there is a reduced seed germination and growth.

4. Mulching

Mulching is required on all seeding. Mulch will protect against erosion before grass is established and will promote faster and earlier establishment. The existence of vegetation sufficient to control soil erosion shall

be deemed compliance with this mulching requirement.

- A. Straw or Hay. Unrotted small grain straw, hay free of seeds, to be applied at the rate of 1-1/2 to 2 tons per acre (70 to 90 pounds per 1,000 square feet), except that where a crimper is used instead of a liquid mulch-binder (tackifying or adhesive agent), the rate of application is 3 tons per acre. Mulch chopper-blowers must not grind the mulch. Hay mulch is not recommended for establishing fine turf or lawns due to the presence of weed seed.

Application - Spread mulch uniformly by hand or mechanically so that at least 85% of the soil surface is covered. For uniform distribution of hand-spread mulch, divide area into approximately 1,000 square feet sections and distribute 70 to 90 pounds within each section.

Anchoring shall be accomplished immediately after placement to minimize loss by wind or water. This may be done by one of the following methods, depending upon the size of the area, steepness of slopes, and costs.

1. Peg and Twine. Drive 8 to 10 inch wooden pegs to within 2 to 3 inches of the soil surface every 4 feet in all directions. Stakes may be driven before or after applying mulch. Secure mulch to soil surface by stretching twine between pegs in a criss-cross and a square pattern. Secure twine around each peg with two or more round turns.
2. Mulch Nettings - Staple paper, jute, cotton, or plastic nettings to the soil surface. Use a degradable netting in areas to be mowed.
3. Crimper (mulch anchoring coulter tool) - A tractor-drawn implement, somewhat like a disc harrow, especially designed to push or cut some of the broadcast long fiber mulch 3 to 4 inches into the soil so as to anchor it and leave part standing upright. This technique is limited to areas traversable by a tractor, which must operate on the contour of slopes. Straw mulch rate must be 3 tons per acre. No tackifying or adhesive agent is required.
4. Liquid Mulch-Binders - May be used to anchor salt hay, hay or straw mulch.
 - a. Applications should be heavier at edges where wind may catch the mulch, in valleys, and at crests of banks. The remainder of the area should be uniform in appearance.
 - b. Use one of the following:
 - (1) Organic and Vegetable Based Binders - Naturally occurring, powder-based, hydrophilic materials when mixed with water formulates a gel and when applied to mulch under satisfactory curing conditions will form membraned networks of insoluble polymers. The vegetable gel shall be physiologically harmless and not result in a phytotoxic effect or impede growth of turf grass. Use at rates and weather conditions as recommended by the manufacturer to anchor mulch materials. Many new products are available, some of which may need further evaluation for use in this state.
 - (2) Synthetic Binders - High polymer synthetic emulsion, miscible with water when diluted and, following application of mulch, drying and curing, shall no longer be soluble or dispersible in water. Binder shall be applied at rates recommended by the manufacturer and remain tacky until germination of grass.

Note: All names given above are registered trade names. This does not constitute a recommendation of these products to the exclusion of other products.

- B. Wood-fiber or paper-fiber mulch - shall be made from wood, plant fibers or paper containing no

growth or germination inhibiting materials, used at the rate of 1,500 pounds per acre (or as recommended by the product manufacturer) and may be applied by a hydroseeder. **Mulch shall not be mixed in the tank with seed.** Use is limited to flatter slopes and during optimum seeding periods in spring and fall.

- C. Pelletized mulch - compressed and extruded paper and/or wood fiber product, which may contain co-polymers, tackifiers, fertilizers, and coloring agents. The dry pellets, when applied to a seeded area and watered, form a mulch mat. Pelletized mulch shall be applied in accordance with the manufacturer's recommendations. Mulch may be applied by hand or mechanical spreader at the rate of 60-75 lbs/1,000 square feet and activated with 0.2 to 0.4 inches of water. This material has been found to be beneficial for use on small lawn or renovation areas, seeded areas where weed-seed free mulch is desired, or on sites where straw mulch and tackifier agent are not practical or desirable. Applying the full 0.2 to 0.4 inches of water after spreading pelletized mulch on the seed bed is extremely important for sufficient activation and expansion of the mulch to provide soil coverage.

5. Irrigation (where feasible)

If soil moisture is deficient supply new seeding with adequate water (a minimum of 1/4 inch applied up to twice a day until vegetation is well established). This is especially true when seedings are made in abnormally dry or hot weather or on droughty sites.

6. Topdressing

Since soil organic matter content and slow release nitrogen fertilizer (water insoluble) are prescribed in Section 2A - Seedbed Preparation in this Standard, no follow-up of topdressing is mandatory. An exception may be made where gross nitrogen deficiency exists in the soil to the extent that turf failure may develop. In that instance, topdress with 10-10-10 or equivalent at 300 pounds per acre or 7 pounds per 1,000 square feet every 3 to 5 weeks until the gross nitrogen deficiency in the turf is ameliorated.

7. Establishing Permanent Vegetative Stabilization

The quality of permanent vegetation rests with the contractor. The timing of seeding, preparing the seedbed, applying nutrients, mulch and other management are essential. The seed application rates in Table 4-3 are required when a Report of Compliance is requested prior to actual establishment of permanent vegetation. Up to 50% reduction in application rates may be used when permanent vegetation is established prior to requesting a Report of Compliance from the district. These rates apply to all methods of seeding. **Establishing permanent vegetation means 80% vegetative cover (of the seeded species) and mowed once.** Note this designation of mowed once does not guarantee the permanency of the turf should other maintenance factors be neglected or otherwise mismanaged.

Table 4-2

Table 4-2			
Permanent Stabilization Mixtures for Various Uses			
Application	<u>PLANTING MIXTURES BY SOIL DRAINAGE CLASS</u>¹ (see Table 4-3)		
	<u>Excessively Drained</u>	<u>Well to Moderately Well Drained</u>	<u>Somewhat Poorly to Poorly Drained</u>
Residential/commercial lots	10, 12, 15	6, 10, 12, 13, 14, 15	16
Pond and channel banks, dikes, berms and dams	2, 5, 6, 10	5, 6, 7, 8, 9, 15	2, 8, 16, 17
Drainage ditches, swales, detention basins	2, 9, 11	2, 7, 9, 11, 12, 17	2, 9, 16, 17
Filter Strips	12	11, 12	11, 12
Grasses waterway, spillways	2, 3, 9, 10, 12	6, 7, 9, 10, 11, 12	2, 9, 11, 12
Recreation areas, athletic fields	5, 12, 15, 18	12, 13, 14, 15, 18	16
<u>Special Problem Sites</u>			
Steep slopes and banks, roadsides, borrow areas	2, 3, 4, 6	2, 3, 5, 7, 8, 9, 10, 15, 18	2, 9, 10, 11, 12
Sand and gravel pits, Sanitary landfills	1, 2, 3, 4, 6, 20	1, 2, 3, 4, 5, 6, 8, 15, 20	2, 8
Dredged material, spoilbanks, Borrow areas	2, 3, 6, 20	2, 3, 6, 11,	2, 8
Streambanks & shorelines ²	2, 8, 20, 21a	2, 8, 19b, 20, 21a, 21b	2, 8, 19a, 21a,b,c,d
Utility rights-of-way	3,7,180	3, 7	8, 9, 17

1. Refer to Soil Surveys for drainage class descriptions.
2. Refer to Soil Bioengineering Standard for additional seed mixtures.
3. Spillways only
4. See Appendix E for description of turf grasses and cultivars

PERMANENT VEGETATIVE MIXTURES, PLANTING RATES AND PLANTING DATES ¹													
SEED MIXTURE ²	PLANTING RATE ³		PLANTING DATES.									MAINTENANCE LEVEL ⁴	REMARKS
			O = Optimal Planting period A = Acceptable Planting period										
	PLANT HARDINESS ZONES (see Figure 4-1)												
	Zone 5b, 6a			Zone 6b			Zone 7a, 7b						
	lbs/acre	lbs/1000 sq. ft.	3/15-5/31	6/1-7/31	8/1-10/1	3/1-4/30	5/1-8/14	8/15-10/15	2/1-4/30	5/1-8/14	8/15-10/30		
WARM SEASON SEED MIXTURES													
1A. For Pinelands National Reserve Seed mixtures see Table 4-4 page 4-17			O			O			O				
1. Switchgrass and/or Coastal panicgrass plus or Flatpea	15 15 20 20	.35 .35 .45 .45	O			O			O			C-D	

2.	Deertongue or Switchgrass Redtop	15 20 1 40	.35 .45 .1 .23	O			O			O			C-D	Use Deertongue if pH < 4.0. Switchgrass is superior wildlife plant. Use for waterways. Redtop provides quick cover.
3.	Switchgrass Deertongue Little Bluestem Sheep fescue plus Partridge pea	15 10 20 20 10	.35 .25 .45 .45 .25	O			O			O			C-D	Pinelands mixture.
4.	Switchgrass Big Bluestem Little Bluestem Sand lovegrass Coastal panicgrass	10 5 5 4 10	.25 .10 .10 .10 .25	O			O			O			C-D	Native warm-season mixture.
5.	Bermudagrass Zoysiagrass (seed) Zoysiagrass (sprigs)	15 30	0.35 0.70	O			O			O			A-D	Bermudagrass has superior salt tolerance. Zoysia has greater wear tolerance
COOL SEASON SEED MIXTURES		130	3	A	A⁵	O	A	A⁵	O	A	A⁵	O		General low-maintenance mixture.

6. Fine Fescue (Blend) Hard Fescue Chewings fescue Strong Creeping Red Fescue Kentucky bluegrass Perennial ryegrass plus White clover (see note at right)	45 20 5	.1 ..5 .10										B-D	White clover can be removed when used to establish lawns
7. Strong Creeping red fescue Kentucky bluegrass Perennial ryegrass or Redtop plus White clover	130 50 20 10 5	3 1 .5 .25 .10	A	A⁵	O	A	A⁵	O	A	A⁵	O	B-D	Suitable waterway mix. Canada bluegrass more drought tolerant. Use Redtop for increased drought-tolerance.
8. Tall fescue (turf-type) or Strong Creeping red fescue or Perennial ryegrass Flatpea	30 30 30 25	.7 .7 .7 .60	O	A⁶		O	A⁶		O	A⁶		B-D	Tall fescue best selected for droughty conditions. Use Creeping red fescue in heavy shade. Use Flatpea to suppress woody vegetation.
9. Deertongue Redtop Wild rye (Elymus) Switchgrass	20 2 15 25	.45 .05 .35 .60	O			O			O			C-D	Native wet mix.

10. Tall fescue (turf-type) Perennial ryegrass or White clover (see note at right)	265 20 40 5	6 5 .25 .10	O	A⁵	A⁵	O	A⁵	A⁵	O	A⁵	A⁵	C-D	white clover can be excluded on lawn sites
11. Kentucky Bluegrass Turf-type Tall fescue	45 45 22	0.33 1 5	A	A⁵	O	A	A⁵	O	A	A⁵	O	C-D	Filter strip use for nutrient uptake.
12. Turf-type Tall fescue (Blend of 3 cultivars)	350	8	A	A⁵	O	A	A⁵	O	A	A⁵	O	C-D	Use in a managed filter strip for nutrient uptake.
13. Hard Fescue and/or Chewing fescue and/or Strong creeping red fescue Perennial ryegrass Ky. bluegrass (blend)	175 45 45	4 1 1	A	A⁵	O	A	A⁵	O	A	A⁵	O	A-C	General lawn/recreation.
14. Tall fescue Ky. bluegrass (blend) Perennial ryegrass (blend)	265 20 20	6 0.50 0.50	A	A⁵	O	A	A⁵	O	A	A⁵	O	A-B	Athletic field/ 3 cultivar mix of Kentucky Bluegrass.
15. Hard fescue Chewings fescue Strong Creeping red fescue Perennial ryegrass	130 45 45 10	3 1 1 .25	A	A⁵	O	A	A⁵	O	A	A⁵	O	C-D	Low-maintenance fine fescue lawn mix.
16. Rough bluegrass Strong Creeping red fescue	90 130	2.0 3	A	A⁵	O	A	A⁵	O	A	A⁵	O	C-D	Moist shade.

17. Creeping bentgrass Creeping red fescue Alkali saltgrass	45 45 45	1 1 1	A	A⁵	O	A	A⁵	O	A	A⁵	O	B-D	Use bentgrass under wetter conditions. Saltgrass will only persistent under saline conditions.
18. Hard or Sheeps fescue N. E. wildflower mixture	25 12	0.60 0.35	O	A	O	O	A	O	O	A	O	C-D	Regional Wildflower mix Hydroseeding not recommended.
19. a. Smooth cordgrass b. Saltmeadow cordgrass	veg veg					O	Before July 1		O	Before July 1		D	Planted in the intertidal zone. Planted above mean high tide.
20. American Beachgrass Coastal Panicgrass	Veg 20	.45					Before April 1		O			D	Coastal Panicgrass may be interseeded between rows of beachgrass
21. a. Purpleosier willow b. Dwarf willow c. Redosier dogwood d. Silky dogwood	veg veg. veg. veg.		Before May 10				Before May 10		Before May 1			D	Also refer to Chapters 16 and 18 of USDA NRCS Engineering Field Handbook

Table 4-3 Footnotes:

1. See Appendix B for descriptions of turf grass mixtures and cultivars. The actual amount of warm-season grass mixture used in Table 3 (seed mix 1-7) shall be adjusted to reflect the amount of PLS as determined by germination testing results. No adjustment is required for cool-season grasses (seed mixtures 8-20).
2. Seeding mixtures and/or rates not listed above may be used if recommended by the local Soil Conservation District, Natural Resources Conservation Service; recommendations of Rutgers Cooperative Extension may be used if approved by the Soil Conservation District. Legumes (white clover, flatpea, lespedeza) should be mixed with proper inoculant prior to planting.
3. Seeding rates specified are required when a report of compliance is requested prior to actual establishment of permanent vegetation. Up to 50% reduction in rates may be used when permanent vegetation is established prior to a report of compliance inspection. These rates apply to all methods of seeding. Establishing permanent vegetation means 80% vegetative coverage of the seeded area and mowed once. Grass seed mixture checked by the State Seed Analyst, New Jersey Department of Agriculture, Trenton, New Jersey, will assure the purchaser that the mixture obtained is the mixture ordered, pursuant to the N.J. State Seed Law, N.J.S.A. 4:8-17.13 et. seq.

O = optimal planting period A = acceptable planting period

4. Maintenance Level:
 - A: Intensive mowing, (2-4 days), fertilization, lime, pest control and irrigation (Examples – high-maintenance lawns, commercial and recreation areas, public facilities).
 - B: Frequent mowing, (4-7 days), occasional fertilization, lime and weed control (Examples - home lawns, commercial sites, school sites).
 - C: Periodic mowing (7-14 days), occasional fertilization and lime (Examples - home lawns, parks).
 - D: Infrequent or no mowing, fertilization and lime the first year of establishment (Examples - roadsides, recreation areas, public open spaces)
5. Summer seedings should only be conducted when the site is irrigated. Mixes including white clover require that at least six weeks of growing season remain after seeding to ensure establishment before freezing conditions.

Figure 4-1: Plant Hardiness Zones in New Jersey

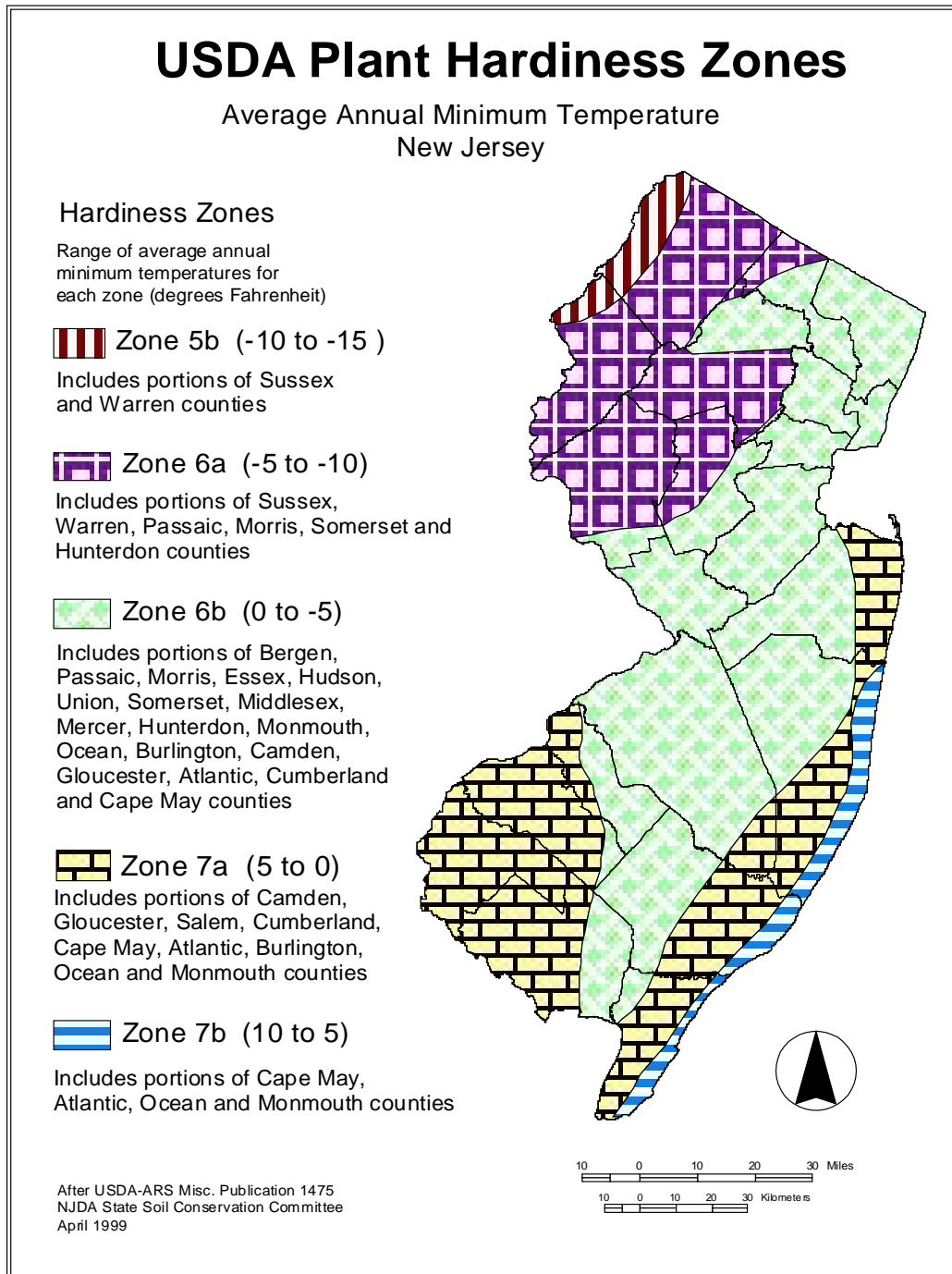

Pinelands National Reserve Specifications

Methods and Materials

Due to the low fertility of native soils and other related factors, indigenous Pinelands vegetation can be relatively slow to re-colonize disturbed areas. Natural re-colonization by native plants is preferable however, where the intended land use permits or requires native plant re-growth

The following approaches shall be used for post-development soil stabilization in the Pinelands National Reserve (PNR) in areas where it is a desire for native plant materials to be used. These practices are limited to areas where slope is less than 2% which do not experience concentrated surface runoff.

Note: areas requiring traditional turf-type vegetation either by seeding or sodding shall be subject to the Standards for Topsoiling or Sodding and the prior portions of this Standard which detail methods for permanent vegetative stabilization. Table 4-4 below contains the required cool season turf mixture suitable for use in the PNR.

PNR A-horizon soil shall be segregated and stockpiled separately to maintain seed and root stock remnants for revegetation efforts outlined below.

Site / Seedbed Preparation.

1. The reuse of stockpiled Pinelands A-Horizon soils to the depth found prior to construction (1.0" minimum) is required for all permanent stabilization efforts involving native plant materials.
2. pH, organic matter, texture and cation exchange capacity (CEC) (as estimated by sum of cations, CEC_{sum}) of any non-native PNR soil shall be equal to or less than that of the native soil on the project site.
 - See Web Soil Survey: <http://websoilsurvey.nrcs.usda.gov/app/WebSoilSurvey.aspx> for typical soil measurements for pH, soil texture, organic matter and CEC.
3. Grade as needed and feasible to permit the use of conventional equipment for seedbed preparation, seeding, mulch application and mulch anchoring. All grading shall be done in accordance with Standards for Land Grading, including methods to alleviate soil compaction (the addition of compost for organic matter shall not exceed the in-situ composition).
4. Sand fencing - Sand fencing (standard snow fence) may be used to address potential wind erosion on large sites (See Sand fencing, Dune Stabilization Standard). Sand fencing shall be used in combination with other permanent stabilization methods to prevent erosion.

Reseeding with Pinelands Approved Seed Mixtures

Appropriate seed mixtures shall be selected from Table 4-4 below. Seed shall be broadcast or drill seeded directly into the A-horizon soils. = Mulch consistent with the Standard.

Re-establishment of Native Vegetation without seeding.

1. In cases where it is desirable or required for native vegetation to be re-established by unassisted re-colonization, A-horizon soils (without added seeding) shall be protected from erosion by any of the following measures until native plant materials (seed and root stock preserved in A-horizon soils and other native volunteer vegetation) re-colonize the area:

- a. Unrotted small-grain straw, at 2.0 to 2.5 tons per acre, is spread uniformly at 90 to 115 pounds per 1,000 square feet and anchored with a mulch anchoring tool, liquid mulch binders, or netting tie down. Other suitable materials may be used if approved by the Soil Conservation District. The approved rates above have been met when the mulch covers the ground completely upon visual inspection.
- b. Light layer (2 inches thick maximum) of wood chips (locally sourced from within the Pinelands National Reserve if available)
- c. Unseeded, Type A¹ (or greater) biodegradable erosion control blanket.
- d. Combinations of the above.
- e. Re-apply mulch materials as needed (to limit erosion) until an adequate cover of native plants is established. * This may require several growing seasons to adequately establish native vegetation.
- f. A bond (estimate to be prepared by a NJ licensed Engineer) may be required by the local Soil Conservation District to ensure the suitable establishment of native vegetation is accomplished. A Final Certificate of Compliance shall not be issued to the overall project site until adequate, permanent vegetative cover is established.
- g.** If natural re-colonization fails after 2 growing seasons, vegetative establishment will require the area to be mechanically seeded with a suitable mixture from Table 4-4 below or otherwise replanted with live vegetation.

* Adequate cover is defined as no visible evidence of off-site erosion with the natural re-colonization appearing to have the same spacing (if not height) as undisturbed vegetation in the immediate vicinity.

¹ Type A – Texas DOT testing labs for non-channel liner blankets

h. Table 4-4 Seeding Rates for Pinelands National Reserve Seed Mixtures

Name	Common name	Growth habit	Soil Drainage Tolerance	Height	Seeding rate lbs./acre
Non-Roadside Pinelands Mixture					
<i>Schizachyrium scoparium</i>	Little bluestem	PIB	EXDR-WD	2-3'	5
<i>Dichanthelium clandestinum</i>	Deertongue	PIB	EXDR-SWPD	1-3'	5
<i>Panicum virgatum</i>	Switchgrass	PIB	EXDR-PD	4-6'	5
<i>Chamaecrista fasciculata</i>	Partridge pea	AB	EXDR-WD	3'	5
Recommended Optional Addition (See recommended Pinelands species for mixture augmentation. Not for Roadsides)					
<i>Andropogon virginicus</i>	Broomsedge	PIB	EXDR-SWPD	18"-3'	5
<i>Solidago bicolor</i>	White (Silver rod) Goldenrod	P	EXDR-WD	1-4'	.5
<i>Lespedeza capitata</i>	Roundheaded bushclover	PIB	EXDR-WD	2-4'	2
<i>Baptisia tinctoria</i>	Wild indigo	PIB	EXDR	1-3'	5
<i>Carex pensylvanica</i>	Pennsylvania sedge	PIS	EXDR-WD	16"	Plugs
Temporary Seeding/Nurse Crops (choose one as a nurse crop where quick germination is needed)					
<i>Hordeum vulgare</i>	Barley	AsB	EXDR-WD	8"-3'	30
<i>Avena sativa</i>	Oats	AB	EXDR-WD	1-3'	30
<i>Elymus canadensis</i>	Canada wildrye	PsB	WD-MWD	3-6'	30
Roadside Native Seed Mixture					
<i>Schizachyrium scoparium</i>	Little bluestem	PIB	EXDR-WD	2-3'	5
<i>Dichanthelium clandestinum</i>	Deertongue	PIB	EXDR-SWPD	1-3'	5
<i>Chamaecrista fasciculata</i>	Partridge pea	AB	EXDR-WD	3'	5
Cool Season Turf Mixture					
<i>Festuca longifolia</i>	Hard fescue	PIB	EXWD-WD	2-3'	50
<i>Festuca rubra ssp. rubra</i>	Strong Creeping red fescue	PIB	EXWD-WD	1-2'	50
<i>Festuca rubra ssp. fallax</i>	Chewings fescue	PIB	EXWD-MWD	1-2'	50
<i>Lolium perenne</i>	Turf-type perennial ryegrass	PsB	EXWD-WD	1-2'	50
Key					
Growth Habit	Soil Drainage Tolerance				
A-Annual	EXDR-Excessively drained				
P-Perennial	WD-Well-drained				
I-Long lived	MWD-Moderately well-drained				
s-short lived	SWPD-Somewhat poorly drained				
R-rizomatous	PD-Poorly drained				
S-stoloniferous					
B-bunch					

Additional Pinelands Approved Species for Augmentation

NOT Recommended for Roadside Plantings

Annual Grasses:

1. Six Weeks Fescue (*Vulpia octoflora*)
2. Three-Awn Grass (*Aristida longispica*)

Perennial Cool-Season Grasses:

1. Poverty Oat Grass (*Danthonia spicata*)
2. Silky Wild Oat Grass (*Danthonia sericea*)
3. Ticklegrass (*Agrostis hyemalis*)

Perennial Warm-Season Grasses:

1. *Dichanthelium* species
2. *Dichanthelium sphaerocarpon*
3. *Dichanthelium depauperatum*
4. *Dichanthelium meridionale*
5. *Dichanthelium sabulorum*

Perennial Herbs:

1. Butterfly-weed (*Asclepias tuberosa*)
2. Grass-leaf Blazing-star (*Liatris pilosa*)
3. Hyssop-leaved Boneset (*Eupatorium hyssopifolium*)
4. Maryland Goldenaster (*Chrysopsis mariana*)
5. Sweet Goldenrod (*Solidago odora*)
6. Toothed Whitetop Aster (*Sericocarpus asteroides*)
7. Trailing Tick-Trefoil (*Desmodium rotundifolium*)

Species which may be more difficult to obtain but whose listing could encourage propagation include:

1. Bearberry (*Arctostaphylos uva-ursi*)
2. Orange-grass, (*Hypericum gentianoides*)
3. Teaberry (*Gaultheria procumbens*)
4. Pine Barren Sandwort (*Minuartia caroliniana*)
5. Hudsonia (*Hudsonia ericoides*)

Pinelands National Reserve Natural Regeneration Process

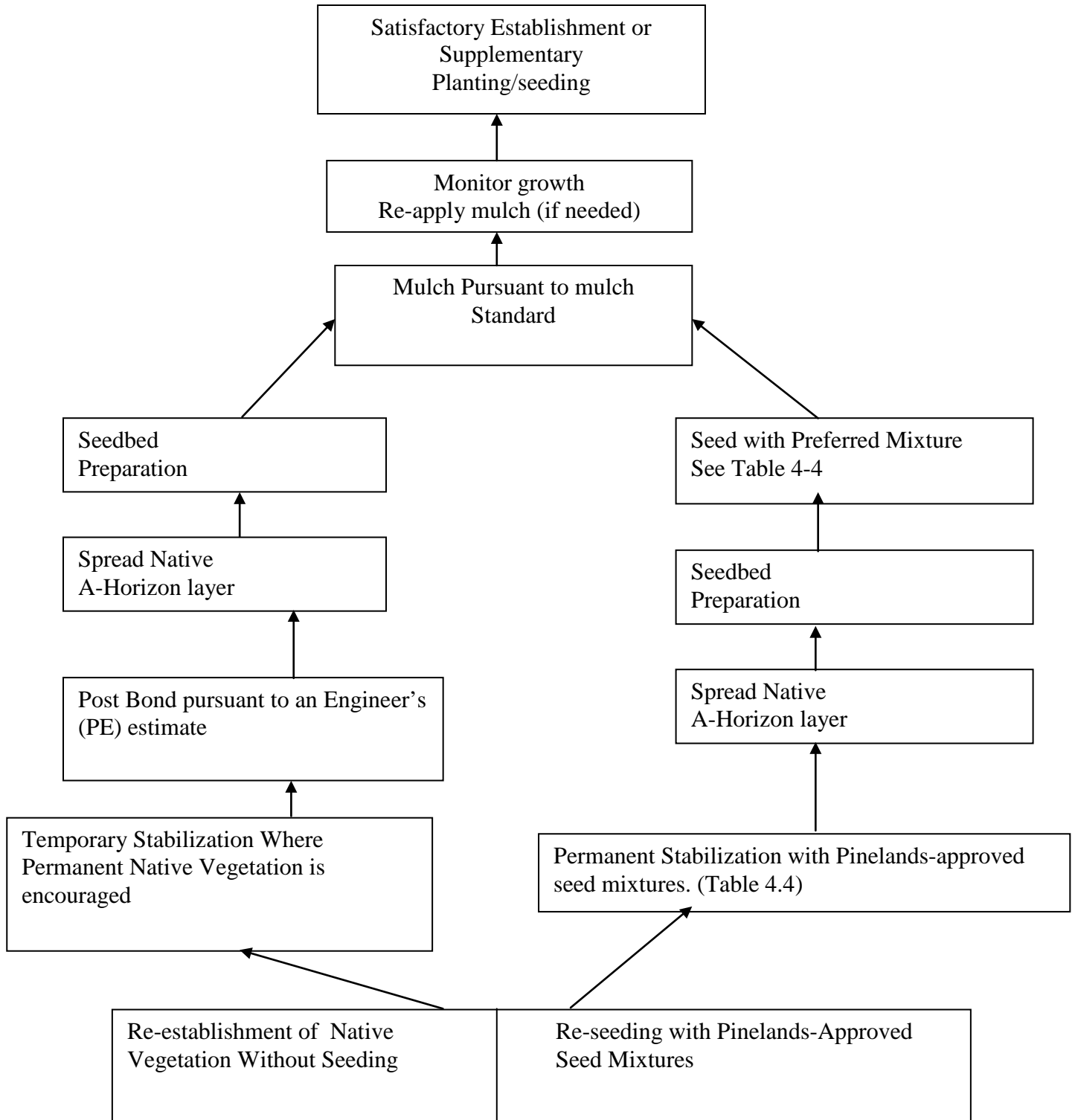

**STANDARD
FOR
STABILIZATION WITH MULCH ONLY**

Definition

Stabilizing exposed soils with non-vegetative materials exposed for periods longer than 14 days

Purpose

To protect exposed soil surfaces from erosion damage and to reduce offsite environmental damage.

Water Quality Enhancement

Provides temporary mechanical protection against wind or rainfall induced soil erosion until permanent vegetative cover may be established.

Where Applicable

This practice is applicable to areas subject to erosion, where the season and other conditions may not be suitable for growing an erosion-resistant cover or where stabilization is needed for a short period until more suitable protection can be applied.

Methods and Materials

1. Site Preparation

- A. Grade as needed and feasible to permit the use of conventional equipment for seedbed preparation, seeding, mulch application, and mulch anchoring. All grading should be done in accordance with Standards for Land Grading
- B. Install needed erosion control practices or facilities such as diversions, grade stabilization structures, channel stabilization measures, sediment basins, and waterways. See Standards 11 through 42.

2. Protective Materials

- A. Unrotted small-grain straw, at 2.0 to 2.5 tons per acre, is spread uniformly at 90 to 115 pounds per 1,000 square feet and anchored with a mulch anchoring tool, liquid mulch binders, or netting tie down. Other suitable materials may be used if approved by the Soil Conservation District. The approved rates above have been met when the mulch covers the ground completely upon visual inspection, i.e. the soil cannot be seen below the mulch.
- C. Synthetic or organic soil stabilizers may be used under suitable conditions and in quantities as recommended by the manufacturer.
- D. Wood-fiber or paper-fiber mulch at the rate of 1,500 pounds per acre (or according to the manufacturer's requirements) may be applied by a hydroseeder.
- E. Mulch netting, such as paper jute, excelsior, cotton, or plastic, may be used.
- F. Woodchips applied uniformly to a minimum depth of 2 inches may be used. Woodchips will not be used on areas where flowing water could wash them into an inlet and plug it.

- G. Gravel, crushed stone, or slag at the rate of 9 cubic yards per 1,000 sq. ft. applied uniformly to a minimum depth of 3 inches may be used. Size 2 or 3 (ASTM C-33) is recommended.
- 3. Mulch Anchoring - should be accomplished immediately after placement of hay or straw mulch to minimize loss by wind or water. This may be done by one of the following methods, depending upon the size of the area and steepness of slopes.
 - A. Peg and Twine - Drive 8 to 10 inch wooden pegs to within 2 to 3 inches of the soil surface every 4 feet in all directions. Stakes may be driven before or after applying mulch. Secure mulch to soil surface by stretching twine between pegs in a criss-cross and a square pattern. Secure twine around each peg with two or more round turns.
 - B. Mulch Nettings - Staple paper, cotton, or plastic nettings over mulch. Use degradable netting in areas to be mowed. Netting is usually available in rolls 4 feet wide and up to 300 feet long.
 - C. Crimper Mulch Anchoring Coulter Tool - A tractor-drawn implement especially designed to punch and anchor mulch into the soil surface. This practice affords maximum erosion control, but its use is limited to those slopes upon which the tractor can operate safely. Soil penetration should be about 3 to 4 inches. On sloping land, the operation should be on the contour.
 - D. Liquid Mulch-Binders
 - 1. Applications should be heavier at edges where wind catches the mulch, in valleys, and at crests of banks. Remainder of area should be uniform in appearance.
 - 2. Use one of the following:
 - a. Organic and Vegetable Based Binders - Naturally occurring, powder based, hydrophilic materials that mixed with water formulates a gel and when applied to mulch under satisfactory curing conditions will form membrane networks of insoluble polymers. The vegetable gel shall be physiologically harmless and not result in a phyto-toxic effect or impede growth of turfgrass. Vegetable based gels shall be applied at rates and weather conditions recommended by the manufacturer.
 - b. Synthetic Binders - High polymer synthetic emulsion, miscible with water when diluted and following application to mulch, drying and curing shall no longer be soluble or dispersible in water. It shall be applied at rates and weather conditions recommended by the manufacturer and remain tacky until germination of grass.

**STANDARD
FOR
PERMANENT STABILIZATION WITH SOD**

Definition

Establishing permanent vegetation using sod.

Purpose

To permanently stabilize topsoil with an immediate aesthetic covering, thus assuring conservation of soil and water, and to enhance the environment.

Water Quality Enhancement

Provides an immediate, permanent vegetative cover to the soil from the impacts of wind or rain and prevents soil and nutrient losses to streams and other stormwater conveyances from stormwater runoff.

Where Applicable

On exposed soils that have a potential for causing off-site environmental damage where an immediate, permanent, vegetative cover is desired. Water (rain or irrigation) is required for success; access to irrigation is essential during drought.

Methods and Materials

1. High quality cultivated sod is preferred over native or pasture sod.
 2. Sod should be free of broadleaf weeds and undesirable coarse and fine weed grasses.
 3. Sod should be of uniform thickness, typically 5/8 inch, plus or minus 1/4 inch, at time of cutting (excludes top growth).
 4. Sod should be vigorous and dense and be able to retain its own shape and weight when suspended vertically with a firm grasp from the upper 10 percent of the strip. Broken pads and rolls or torn and uneven ends will not be acceptable.
 5. For droughty sites, a sod of turf-type tall fescue or turf-type tall fescue mixed with Kentucky bluegrass is preferred over a 100% Kentucky bluegrass sod. Although not widely available, a sod of fine fescue is also acceptable for droughty sites.
 6. Only moist, fresh, unheated sod should be used. Sod should be harvested, delivered, and installed within a period of 24 hours or less during summer months.
1. Site Preparation
 - A. Grade as needed and feasible to permit the use of conventional equipment for liming, fertilizing, incorporation of organic matter, and other soil preparation procedures. All grading should be done in accordance with Standard for Land Grading.
 - B. Topsoil should be handled only when it is dry enough to work without damaging the soil structure. A uniform application to a depth of 6 inches (unsettled) is required on all sites.

See the Standard for Topsoiling for topsoil and amendment requirements.

- C. Install needed erosion control practices or facilities such as diversions, grade stabilization structures, channel stabilization measures, sediment basins, and waterways

2. Soil Preparation

- A. Uniformly apply ground limestone, and fertilizer according to soil test recommendations such as offered by Rutgers Co-operative Extension. Soil sample mailers are available from the local Rutgers Cooperative Extension offices (<http://njaes.rutgers.edu/county/>). Fertilizer shall be applied at the rate of 500 pounds per acre or 11 pounds per 1,000 square feet using 10-10-10 or equivalent with 50% water insoluble nitrogen unless a soil test indicates otherwise and incorporated into the surface 4 inches. If fertilizer is not incorporated, apply ½ the rate described above during seedbed preparation and repeat another ½ rate application of the same fertilizer within 3 to 5 weeks after seeding. Apply limestone at the rate of 2 tons/acre unless soil testing indicates otherwise. Calcium carbonate is the equivalent and standard for measuring the ability of liming materials to neutralize soil acidity and supply calcium and magnesium to grasses and legumes. Table 6-1 is a general guideline for limestone application rates.

Table 6-1

Limestone ¹ Application Rate by Soil Texture		
SOIL TEXTURE	TONS/ACRE	LBS./1000 SQ. FT.
Clay, clay loam, and high organic soil	3	135
Sandy loam, loam, silt loam	2	90
Loamy sand, sand	1	45

1. Pulverized dolomitic limestone is preferred for most soils south of the New Brunswick-Trenton line; however, this should be confirmed by soil testing.

- B. Work lime, and fertilizer into the topsoil as nearly as practical to a depth of 4 inches with a disc, springtooth harrow, or other suitable equipment. The final harrowing or disking operation should be on the general contour. Continue tillage until a reasonably uniform, fine seedbed is prepared.
- C. Remove from the surface all objects that would prevent good sod to topsoil contact and remove all other debris, such as wire, cable, tree roots, pieces of concrete, clods, lumps, or other unsuitable material.
- D. Inspect site just before sodding. If traffic has left the soil compacted, the area must be retilled and firmed in accordance with the above.

3. Sod Placement

- A. Sod strips should be laid on the contour, never up and down the slope, starting at the bottom of the slope and working up. On steep slopes, the use of ladders will facilitate the

- work and prevent damage to the sod. During periods of high temperature, lightly irrigate the soil immediately prior to laying the sod.
- B. Place sod strips with snug, even joints (seams) that are staggered. Open spaces invite erosion.
 - C. Lightly roll or tamp sod immediately following placement to insure solid contact of root mat and soil surface. Do not overlap sod. All joints should be butted tightly to prevent voids which would cause drying of the roots and invasion of weeds.
 - D. On slopes greater than 3 to 1, secure sod to surface soil with wood pegs, wire staples biodegradable plastic spikes, or split shingles (8 to 10 inches long by 3/4 inch wide).
 - E. Surface water cannot always be diverted from flowing over the face of the slope, but a capping strip of heavy jute or plastic netting, properly secured, along the crown of the slope and edges will provide extra protection against lifting and undercutting of sod. The same technique can be used to anchor sod in water-carrying channels and other critical areas. Wire staples must be used to anchor netting in channel work.
 - F. Immediately following installation, sod should be watered until water penetrates the soil layer beneath sod to a depth of 1 inch. Maintain optimum water for at least two weeks.
4. Topdressing - Since soil organic matter and slow release nitrogen fertilizer (water insoluble) are prescribed in Sections 1 and 2 in this Standard, a follow-up topdressing is not mandatory, except where gross nitrogen deficiency exists in the soil to the extent that turf failure may develop, topdressing shall then be applied. Topdress with 10-0-10 or equivalent at 400 pounds per acre or 7 pounds per 1,000 square feet every 3 to 5 weeks until the gross nitrogen deficiency in the turf is ameliorated.

TEMPORARY VEGETATIVE COVER FOR SOIL STABILIZATION

Definition

Establishment of temporary vegetative cover on soils exposed for periods of two to 6 months which are not being graded, not under active construction or not scheduled for permanent seeding within 60 days.

Purpose

To temporarily stabilize the soil and reduce damage from wind and water erosion until permanent stabilization is accomplished.

Water Quality Enhancement

Provides temporary protection against the impacts of wind and rain, slows the over land movement of stormwater runoff, increases infiltration and retains soil and nutrients on site, protecting streams or other stormwater conveyances.

Where Applicable

On exposed soils that have the potential for causing off-site environmental damage.

Methods and Materials

1. Site Preparation
 - A. Grade as needed and feasible to permit the use of conventional equipment for seedbed preparation, seeding, mulch application, and mulch anchoring. All grading should be done in accordance with Standards for Land Grading, pg. 19-1.
 - B. Install needed erosion control practices or facilities such as diversions, grade stabilization structures, channel stabilization measures, sediment basins, and waterways. See Standards 11 through 42.
 - C. Immediately prior to seeding, the surface should be scarified 6" to 12" where there has been soil compaction. **This practice is permissible only where there is no danger to underground utilities (cables, irrigation systems, etc.).**
2. Seedbed Preparation
 - A. Apply ground limestone and fertilizer according to soil test recommendations such as offered by Rutgers Co-operative Extension. Soil sample mailers are available from the local Rutgers Cooperative Extension offices. Fertilizer shall be applied at the rate of 500 pounds per acre or 11 pounds per 1,000 square feet of 10-20-10 or equivalent with 50% water insoluble nitrogen unless a soil test indicates otherwise. Apply limestone at the rate of 2 tons/acre unless soil testing indicates otherwise. Calcium carbonate is the equivalent and standard for measuring the ability of liming materials to neutralize soil acidity and supply calcium and magnesium to grasses and legumes.
 - B. Work lime and fertilizer into the soil as nearly as practical to a depth of 4 inches with a disc, springtooth harrow, or other suitable equipment. The final harrowing or disking operation should

be on the general contour. Continue tillage until a reasonable uniform seedbed is prepared.

- C. Inspect seedbed just before seeding. If traffic has left the soil compacted, the area must be retilled in accordance with the above.
- D. Soils high in sulfides or having a pH of 4 or less refer to Standard for Management of High Acid Producing Soils, pg. 1-1.

3. Seeding

- A. Select seed from recommendations in Table 7-2.

TABLE 7-2

TEMPORARY VEGETATIVE STABILIZATION GRASSES, SEEDING RATES, DATES AND DEPTH.

SEED SELECTIONS	SEEDING RATE ¹ (pounds)		OPTIMUM SEEDING DATE ² Based on Plant Hardiness Zone ³			OPTIMUM SEED DEPTH ⁴ (inches)
	Per Acre	Per 1000 Sq. Ft.	ZONE 5b, 6s	ZONE 6b	ZONE 7a, b	
COOL SEASON GRASSES						
1. Perennial ryegrass	100	1.0	3/15- 6/1 8/1- 9/15	3/1- 5/15 8/15- 10/1	2/15- 5/1 8/15- 10/15	0.5
2. Spring oats	86	2.0	3/15- 6/1 8/1- 9/15	3/1- 5/15 8/15- 10/1	2/15- 5/1 8/15- 10/15	1.0
3. Winter Barley	96	2.2	8/1- 9/15	8/15- 10/1	8/15- 10/15	1.0
4. Annual ryegrass	100	1.0	3/15- 6/1 8/1- 9/15	3/15- 6/1 8/1- 9/15	2/15- 5/1 8/15- 10/15	0.5
5. Winter Cereal Rye	112	2.8	8/1 - 11/1	8/1 - 11/15	8/1 - 12/15	1.0
WARM SEASON GRASSES						
6. Pearl millet	20	0.5	6/1-8/1	5/15- 8/15	5/1-9/1	1.0

7. Millet (German or Hungarian)	30	0.7	6/1-8/1	5/15-8/15	5/1-9/1	1.0
---------------------------------	----	-----	---------	-----------	---------	-----

- 1 Seeding rate for warm season grass, selections 5 - 7 shall be adjusted to reflect the amount of Pure Line Seed (PLS) as determined by a germination test result. No adjustment is required for cool season grasses.
- 2 May be planted throughout summer if soil moisture is adequate or seeded area can be irrigated.
- 3 Plant Hardiness Zone (see figure 7-1, pg. 7-4.)
- 4 Twice the depth for sandy soils

- B. Conventional Seeding. Apply seed uniformly by hand, cyclone (centrifugal) seeder, drop seeder, drill or cultipacker seeder. Except for drilled, hydroseeded or cultipacked seedings, seed shall be incorporated into the soil, to a depth of 1/4 to 1/2 inch, by raking or dragging. Depth of seed placement may be 1/4 inch deeper on coarse textured soil.
- C. Hydroseeding is a broadcast seeding method usually involving a truck or trailer mounted tank, with an agitation system and hydraulic pump for mixing seed, water and fertilizer and spraying the mix onto the prepared seedbed. Mulch **shall not** be included in the tank with seed. Short fibered mulch may be applied with a hydroseeder following seeding. (also see Section IV Mulching) Hydroseeding is not a preferred seeding method because seed and fertilizer are applied to the surface and not incorporated into the soil. Poor seed to soil contact occurs reducing seed germination and growth. Hydroseeding may be used for areas too steep for conventional equipment to traverse or too obstructed with rocks, stumps, etc.
- D. After seeding, firming the soil with a corrugated roller will assure good seed-to-soil contact, restore capillarity, and improve seedling emergence. This is the preferred method. When performed on the contour, sheet erosion will be minimized and water conservation on site will be maximized.

4. Mulching

Mulching is required on all seeding. Mulch will insure against erosion before grass is established and will promote faster and earlier establishment. The existence of vegetation sufficient to control soil erosion shall be deemed compliance with this mulching requirement.

- A. Straw or Hay. Unrotted small grain straw, hay free of seeds, applied at the rate of 1-1/2 to 2 tons per acre (70 to 90 pounds per 1,000 square feet), except that where a crimper is used instead of a liquid mulch-binder (tackifying or adhesive agent), the rate of application is 3 tons per acre. Mulch chopper-blowers must not grind the mulch. Hay mulch is not recommended for establishing fine turf or lawns due to the presence of weed seed.

Application. Spread mulch uniformly by hand or mechanically so that approximately 95% of the soil surface will be covered. For uniform distribution of hand-spread mulch, divide area into approximately 1,000 square feet sections and distribute 70 to 90 pounds within each section.

Anchoring shall be accomplished immediately after placement to minimize loss by wind or water. This may be done by one of the following methods, depending upon the size of the area, steepness of slopes, and costs.

1. Peg and Twine. Drive 8 to 10 inch wooden pegs to within 2 to 3 inches of the soil surface every 4 feet in all directions. Stakes may be driven before or after applying mulch. Secure mulch to soil surface by stretching twine between pegs in a criss-cross and a square pattern. Secure twine around each peg with two or more round turns.
2. Mulch Nettings. Staple paper, jute, cotton, or plastic nettings to the soil surface. Use a degradable netting in areas to be mowed.

3. Crimper (mulch anchoring tool). A tractor-drawn implement, somewhat like a disc harrow, especially designed to push or cut some of the broadcast long fiber mulch 3 to 4 inches into the soil so as to anchor it and leave part standing upright. This technique is limited to areas traversable by a tractor, which must operate on the contour of slopes. Straw mulch rate must be 3 tons per acre. No tackifying or adhesive agent is required.

4. Liquid Mulch-Binders. – May be used to anchor hay or straw mulch.

a. Applications should be heavier at edges where wind may catch the mulch, in valleys, and at crests of banks. The remainder of the area should be uniform in appearance.

b. Use one of the following:

(1) Organic and Vegetable Based Binders – Naturally occurring, powder based, hydrophilic materials when mixed with water formulates a gel and when applied to mulch under satisfactory curing conditions will form membraned networks of insoluble polymers. The vegetable gel shall be physiologically harmless and not result in a phytotoxic effect or impede growth of turfgrass. Use at rates and weather conditions as recommended by the manufacturer to anchor mulch materials. Many new products are available, some of which may need further evaluation for use in this state.

(2) Synthetic Binders – High polymer synthetic emulsion, miscible with water when diluted and following application to mulch, drying and curing shall no longer be soluble or dispersible in water. It shall be applied at rates recommended by the manufacturer and remain tacky until germination of grass.

Note: All names give above are registered trade names. This does not constitute a commendation of these products to the exclusion of other products.

B. Wood-fiber or paper-fiber mulch. Shall be made from wood, plant fibers or paper containing no growth or germination inhibiting materials, used at the rate of 1,500 pounds per acre (or as recommended by the project manufacturer) and may be applied by a hydroseeder. This mulch shall not be mixed in the tank with seed. Use is limited to flatter slopes and during optimum seeding periods in spring and fall.

C. Pelletized mulch. Compressed and extruded paper and/or wood fiber product, which may contain co-polymers, tackifiers, fertilizers and coloring agents. The dry pellets, when applied to a seeded area and watered, form a mulch mat. Pelletized mulch shall be applied in accordance with the manufacturers recommendations. Mulch may be applied by hand or mechanical spreader at the rate of 60-75 lbs./1,000 square feet and activated with 0.2 to 0.4 inches of water. This material has been found to be beneficial for use on small lawn or renovation areas, seeded areas where weed-seed free mulch is desired or on sites where straw mulch and tackifier agent are not practical or desirable.

Applying the full 0.2 to 0.4 inches of water after spreading pelletized mulch on the seed bed is extremely important for sufficient activation and expansion of the mulch to provide soil coverage.

USDA Plant Hardiness Zones

Average Annual Minimum Temperature
New Jersey

Hardiness Zones

Range of average annual minimum temperatures for each zone (degrees Fahrenheit)

 Zone 5b (-10 to -15)

Includes portions of Sussex and Warren counties

 Zone 6a (-5 to -10)

Includes portions of Sussex, Warren, Passaic, Morris, Somerset and Hunterdon counties

 Zone 6b (0 to -5)

Includes portions of Bergen, Passaic, Morris, Essex, Hudson, Union, Somerset, Middlesex, Mercer, Hunterdon, Monmouth, Ocean, Burlington, Camden, Gloucester, Atlantic, Cumberland and Cape May counties

 Zone 7a (5 to 0)

Includes portions of Camden, Gloucester, Salem, Cumberland, Cape May, Atlantic, Burlington, Ocean and Monmouth counties

 Zone 7b (10 to 5)

Includes portions of Cape May, Atlantic, Ocean and Monmouth counties

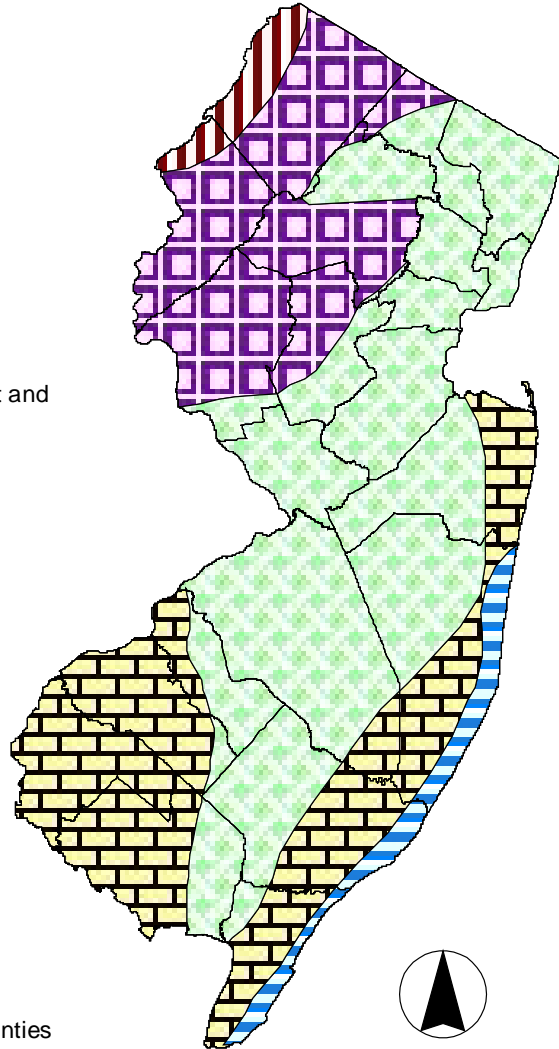

After USDA-ARS Misc. Publication 1475
NJDA State Soil Conservation Committee
April 1999

STANDARD FOR TOPSOILING

Definition

Topsoiling entails the distribution of suitable quality soil on areas to be vegetated.

Purpose

To improve the soil medium for plant establishment and maintenance.

Water Quality Enhancement

Growth and establishment of a vigorous vegetative cover is facilitated by topsoil, preventing soil loss by wind and rain offsite and into streams and other stormwater conveyances.

Where Applicable

Topsoil shall be used where soils are to be disturbed and will be revegetated.

Methods and Materials

1. Materials

- A. Topsoil should be friable¹, loamy², free of debris, objectionable weeds and stones, and contain no toxic substance or adverse chemical or physical condition that may be harmful to plant growth. Soluble salts should not be excessive (conductivity less than 0.5 millimhos per centimeter. More than 0.5 millimhos may desiccate seedlings and adversely impact growth). Imported topsoil shall have a minimum organic matter content of 2.75 percent. Organic matter content may be raised by additives.
- B. Topsoil substitute is a soil material which may have been amended with sand, silt, clay, organic matter, fertilizer or lime and has the appearance of topsoil. Topsoil substitutes may be utilized on sites with insufficient topsoil for establishing permanent vegetation. All topsoil substitute materials shall meet the requirements of topsoil noted above. Soil tests shall be performed to determine the components of sand, silt, clay, organic matter, soluble salts and pH level.

2. Stripping and Stockpiling

- A. Field exploration should be made to determine whether quantity and or quality of surface soil justifies stripping.
- B. Stripping shall be confined to the immediate construction area.
- C. Where feasible, lime may be applied before stripping at a rate determined by soil tests to bring the soil pH to approximately 6.5.
- D. A 4-6 inch stripping depth is common, but may vary depending on the particular soil.

¹Friable means easily crumbles in the fingers, as defined in most soils texts.

²Loamy means texture groups consisting of coarse loamy sands, sandy loam, fine and very fine sandy loam, loam, silt loam, clay loam, sandy clay loam and silty clay loam textures and having less than 35% coarse fragments (particles less than 2mm in size) as defined in the Glossary of Soil Science Terms, 1996, Soil Science Society of America.

- E. Stockpiles of topsoil should be situated so as not to obstruct natural drainage or cause off-site environmental damage.
 - F. Stockpiles should be vegetated in accordance with standards previously described herein; see standards for Permanent (pg. 4-1) or Temporary (pg.7-1) Vegetative Cover for Soil Stabilization. Weeds should not be allowed to grow on stockpiles.
3. Site Preparation
- A. Grade at the onset of the optimal seeding period so as to minimize the duration and area of exposure of disturbed soil to erosion. Immediately proceed to establish vegetative cover in accordance with the specified seed mixture. Time is of the essence
 - B. Grade as needed and feasible to permit the use of conventional equipment for seedbed preparation, seeding, mulch application and anchoring, and maintenance. See the Standard for Land Grading, pg. 19-1.
 - C. As guidance for ideal conditions, subsoil should be tested for lime requirement. Limestone, if needed, should be applied to bring soil to a pH of approximately 6.5 and incorporated into the soil as nearly as practical to a depth of 4 inches.
 - D. Prior to topsoiling, the subsoil shall be in compliance with the Standard for Land Grading, pg. 19-1.
 - E. Employ needed erosion control practices such as diversions, grade stabilization structures, channel stabilization measures, sedimentation basins, and waterways. See Standards 11 through 42.
4. Applying Topsoil
- A. Topsoil should be handled only when it is dry enough to work without damaging soil structure; i.e., less than field capacity (see glossary).
 - B. A uniform application to an average depth of 5.0 inches, minimum of 4 inches, firmed in place is required. Alternative depths may be considered where special regulatory and/or industry design standards are appropriate such as on golf courses, sports fields, landfill capping, etc.. Soils with a pH of 4.0 or less or containing iron sulfide shall be covered with a minimum depth of 12 inches of soil having a pH of 5.0 or more, in accordance with the Standard for Management of High Acid Producing Soil (pg. 1-1).
 - C. Pursuant to the requirements in Section 7 of the Standard for Permanent Vegetative Stabilization, the contractor is responsible to ensure that permanent vegetative cover becomes established on at least 80% of the soils to be stabilized with vegetation. Failure to achieve the minimum coverage may require additional work to be performed by the contractor to include some or all of the following: supplemental seeding, re-application of lime and fertilizers, and/or the addition of organic matter (i.e. compost) as a top dressing. Such additional measures shall be based on soil tests such as those offered by Rutgers Cooperative Extension Service or other approved laboratory facilities qualified to test soil samples for agronomic properties.

**STANDARD
FOR TREE PROTECTION DURING CONSTRUCTION**

Definition

The protection of trees from environmental and mechanical injury during construction activities.

Purpose

To protect trees for erosion and sediment control, shade, aesthetics, wildlife, dust control, noise abatement, and oxygen production.

Water Quality Enhancement

Limiting areas of site disturbance and re-vegetating with permanent cover, minimizes off site and negative downstream water quality impacts caused by stormwater runoff. Mature trees provide structural stability for soils, promote proper water movement through the soil profile and moderate changes in temperature along streams and other water bodies.

Where Applicable

On new development sites with existing trees.

Methods and Materials

1. Reconnaissance should be performed before land clearing begins to identify dead and weak trees to be removed and healthy trees to remain, to create aesthetically pleasing development site with vegetation rather than the presence of dead or dying trees. Inventory the site and clearly mark the trees and stands of trees to be saved. Consider relocating streets, houses, or other structures if necessary and feasible. Once clearing begins and damage to the trees occurs, valuable specimens may be lost.
 - A. Characteristics of trees to be protected and saved. The following lists characteristics that should be evaluated before deciding to remove or protect a tree.
 1. **Tree Vigor**

Tree health is the overall condition of the tree. A tree of low vigor is more susceptible to damage by environmental changes than healthy trees and is more susceptible to insect and disease attacks. Indications of poor vigor include the dying of the tips of branches and entire limbs, small annual twig growth, stunted leaf size, sparse foliage, and poor foliage color. Avoid saving hollow or rotten trees, trees cracked, split, leaning or crooked, oozing sap, or with broken tops. Use woodchips generated from removal of trees of poor health and spread them around the root zones to help protect the trees that remain.
 2. **Tree Age**

Large, picturesque trees may be more aesthetically valuable than smaller, young trees, but also require more extensive protection measures. If leaving an older tree, be sure it is sound and healthy.

3. **Species** (the right trees for the right locations)

Many species of trees found in New Jersey woodlands are not suitable for shade tree uses around buildings. Avoid protecting trees that are short-lived, brittle, have soft wood, messy leaves, fruit, or are frequently attacked by insects and disease. Tree root systems which do not adapt well to cuts and fills may not be a suitable alternative. The following are severely affected by compacted construction fills: Aspen, Beech, Paper birch, Eastern red cedar, Black cherry, Dogwood, Katsura tree, Linden, Paperbark maple, Sugar maple, Black oak, Pin oak, Red oak, White oak, Pines, and Tuliptree. See Table 9-1 for a more complete list of construction impacts to individual tree species.

4. **Resistant to Insects and Diseases**

Avoid leaving trees in highly visible areas or specimens that are frequent targets of insects and diseases. American Elm, for example, could be lost due to Dutch Elm Disease. Wild Cherry, another example, is a favorite host of the tent caterpillar, which causes defoliation of the trees in early summer. The following are susceptible to insects (I) and disease (D): White Ash(D), Birch (I), Butternut (D), Crabapples (D), some Elms (D), Hawthorn (D), Hemlock (I), Linden (I), Sugar Maple (D), Mountain Ash (D), Sassafras (I), Scholartree (D), Redbud (D)

5. **Tree Aesthetics**

Choose trees that are aesthetically pleasing, exhibiting good shape and form. Avoid leaning, crooked, and misshapen trees. Occasionally, an odd-shaped tree or one of unusual form may add interest to the landscape if strategically located. Be sure the tree is structurally sound and vigorous.

6. **Spring and Autumn Coloration**

Species differ in fall color. Some are bright red, others orange and yellow. Other species exhibit no autumn color, such as walnut, locust, and sycamore.

7. **Wildlife Benefits**

Favor trees that are preferred by wildlife for food, cover, and nesting. A mixture of evergreens and hardwoods is beneficial. Evergreen trees are important for cover during the winter months. The hardwoods are more valuable for food.

8. **Air Pollution Susceptibility**

Tree species vary greatly to susceptibility to air pollution. Symptoms vary from browning on the edges of the leaves and needles, to stunting of growth, to death of the tree. The following show tolerance to urban stress and are less likely to present problems with sidewalks: Baldcypress, Corktree, Amur maple, Kentucky coffee tree, Crabapple, Dawn redwood, Ginkgo (male), Goldenraintree, Hackberry, Hawthorn, Honeylocust, European hornbeam, Horsechestnut, Lindens, Oaks (excluding pin), Pear, Scholartree, Sourgum (tupelo), Sweetgum, Yews, Zelkova.

9. **Species Longevity**

Favor trees whose life span is long, such as oak, beech, and tulip poplar. Short-lived

trees; (Black locust, Gray birch, Aspen) should be avoided for use as shade, lawn or specimen trees. Although some short-lived trees have an attractive form or pleasing coloration in the spring or fall, such trees may not live for a long time and thus may not be worth preserving.

B. Criteria for protecting remaining trees:

1. General mechanical damage - see Figure 9.3 for correct root zone calculation and placement of tree protection.
2. Box trees within 25 feet of a building site to prevent mechanical injury. Fencing or other barrier should be installed beyond the *Critical Root Radius*. See Figure 9.3. Tree root systems commonly extend well beyond the drip line.
3. Boards will not be nailed to trees during building operations.
4. Feeder roots should not be cut in an area inside the *Protected Root Zone* (PRZ).
5. Damaged trunks or exposed roots should have damaged bark removed immediately and no paint shall be applied. Exposed roots should be covered with topsoil immediately after excavation is complete. Roots shall be pruned to give a clean, sharp surface amenable to healing. Roots exposed during hot weather should be irrigated to prevent permanent tree injury. Care for serious injury should be prescribed by a professional forester or licensed tree expert.
6. Tree limb removal, where necessary, will be done as natural target pruning to remove the desired branch as close as possible to the branch collar. There should be NO flush cuts. Flush cuts destroy a major defense system of the tree. See Figure 9-1. No tree paint shall be applied. All cuts shall be made at the outside edge of the branch collar (fig. 9-1 and 9-2). Cuts made too far beyond the branch collar may lead to excess sprouting, cracks and rot. Removal of a "V" crotch should be considered for free standing specimen trees (see Figure 9-2) to avoid future splitting damage.

Note: For more specific data on certain tree characteristics by species, see Table 9.1, *Tree Characteristics* or consult with a Licensed Professional Tree Expert, Soil Conservation District or Rutgers Cooperative Extension.

Figure 9-1- Removal of Tree Limb

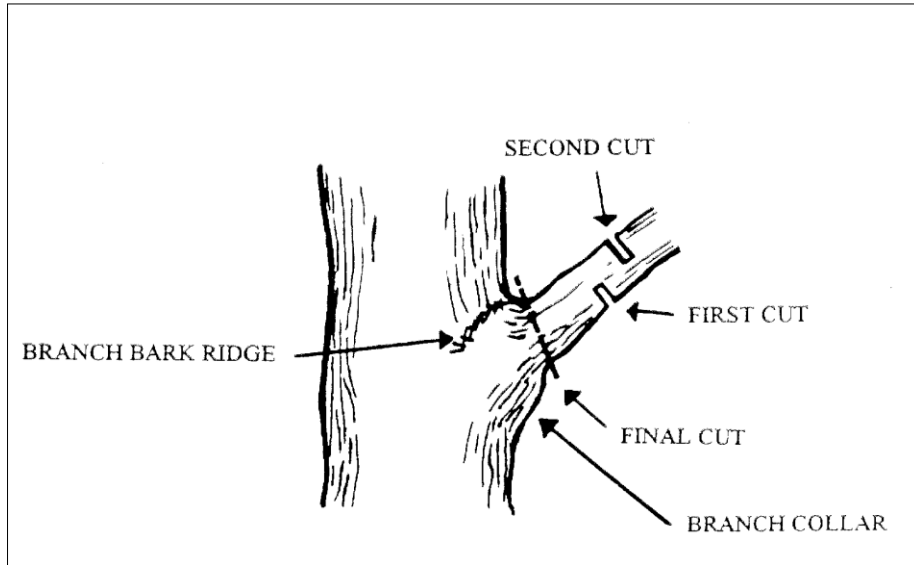

Figure 9-2 - Removal of "V" Crotch Limb

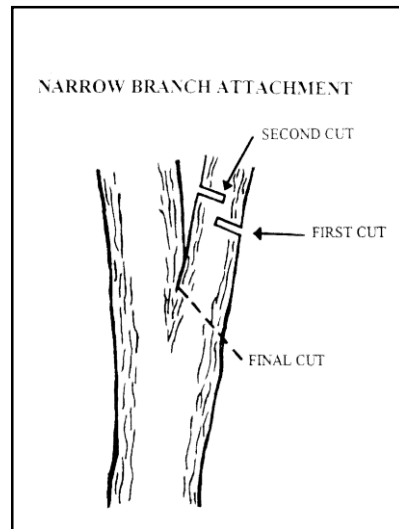

Figure 9-3: Root Protection During Construction Guide

Estimate a tree's **Protected Root Zone (PRZ)** by calculating the Critical Root Radius (crr).

1. Measure the dbh (diameter of tree at breast height, 4.5 feet above ground on the uphill side of tree) in inches.
2. Multiply measured dbh by 1.5 or 1.0. Express the result in feet.

Dbh x 1.5: **Critical root radius** for older, unhealthy, or sensitive species.

Dbh x 1.0: **Critical root radius** for younger, healthy or tolerant species.

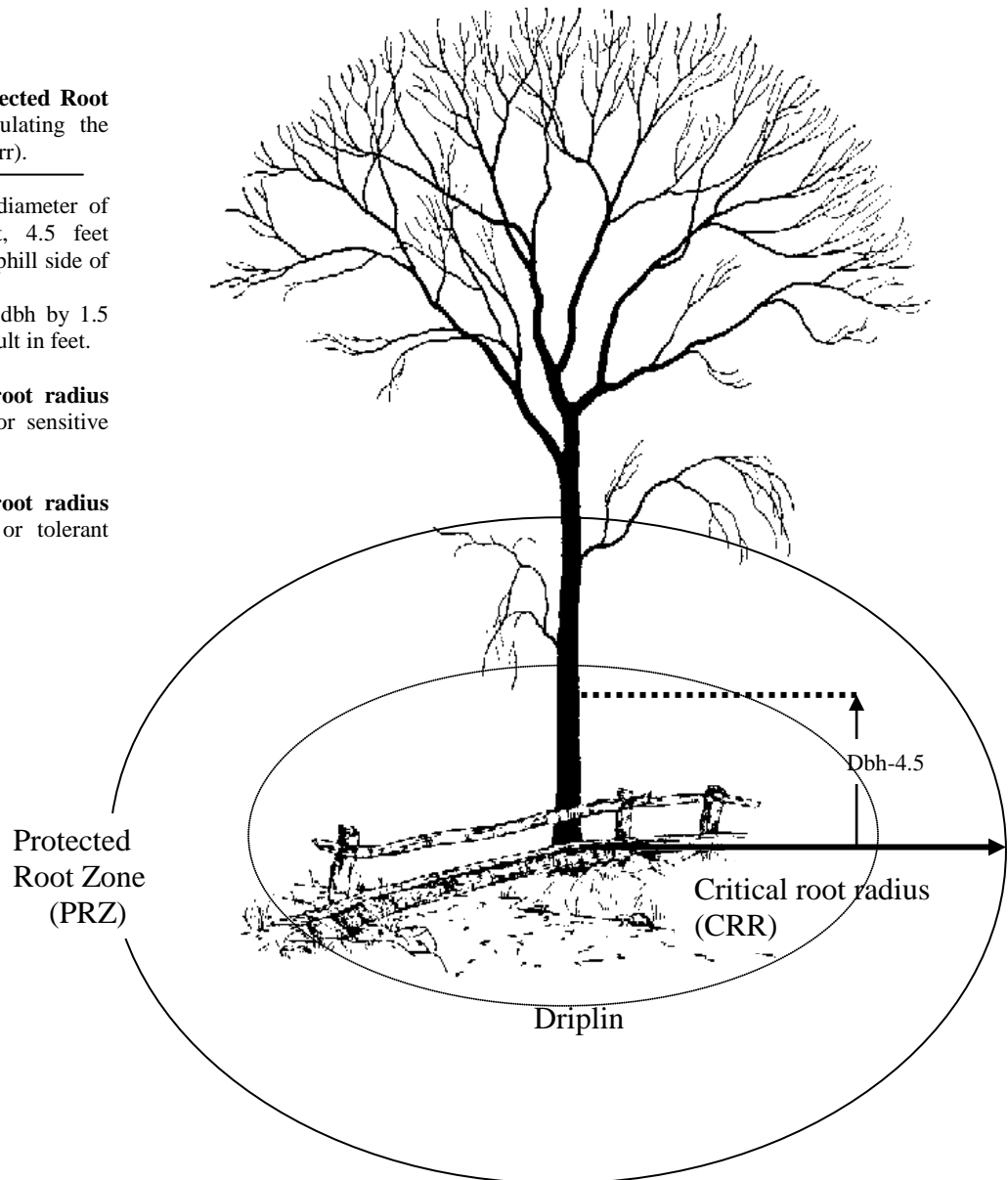

1. *Protecting Trees from Construction Damage- A Homeowners Guide*, Gary R. Johnson, University Of Minnesota Extension Service, Saint Paul, MN, 1999.

Figure 9-4: Tree Protection in Fill Areas

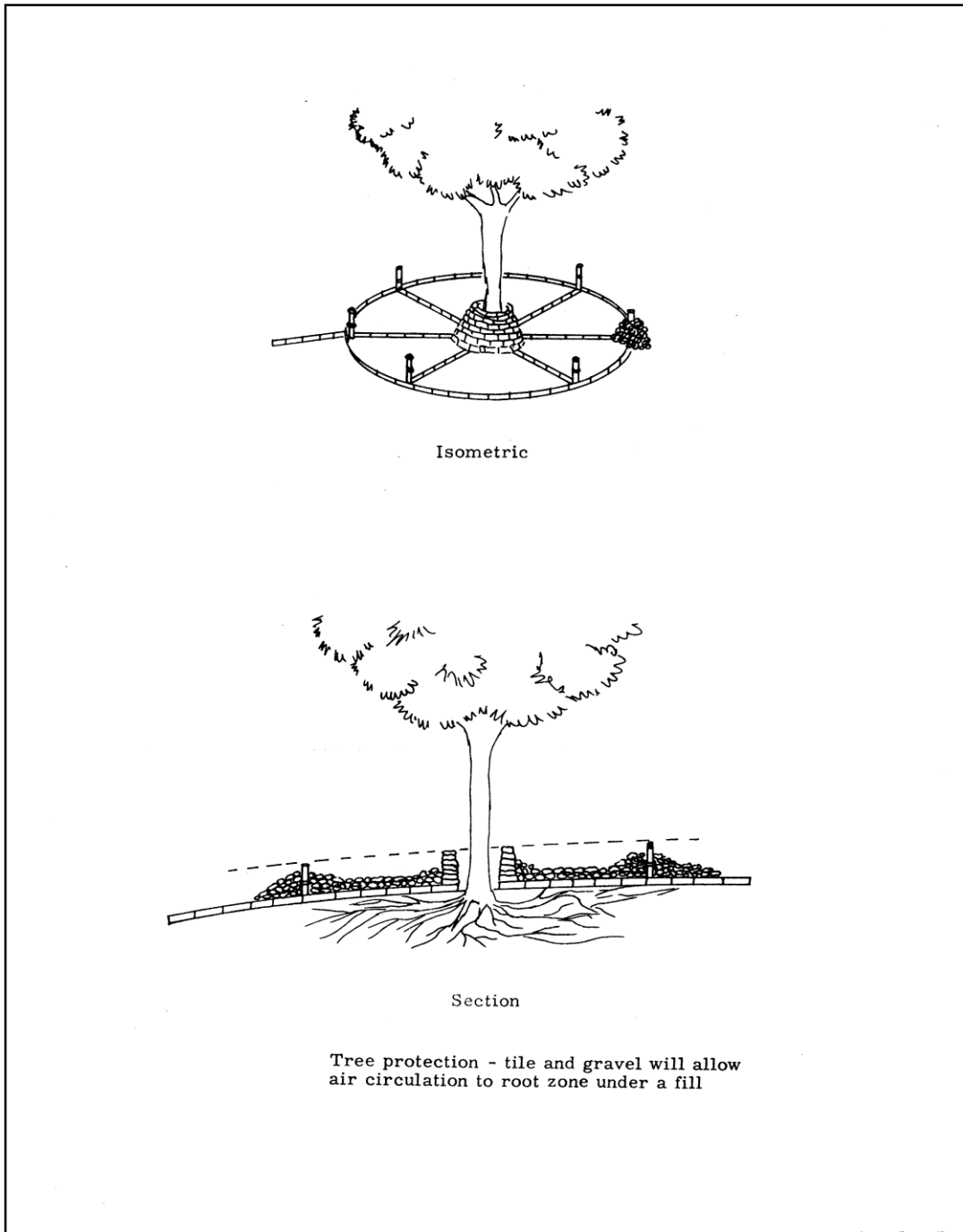
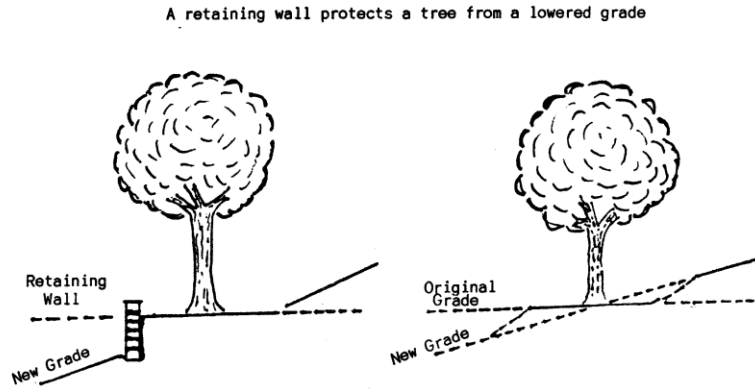
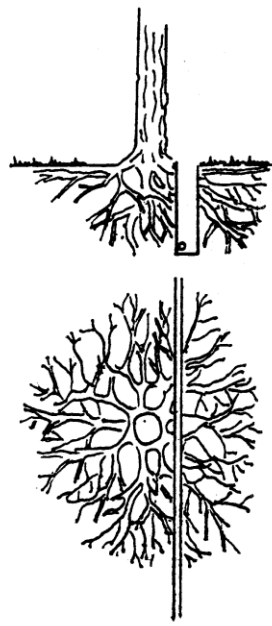

Figure 9-5: Tree Protection in Cut Areas



Trenching



Tunneling - Preferred

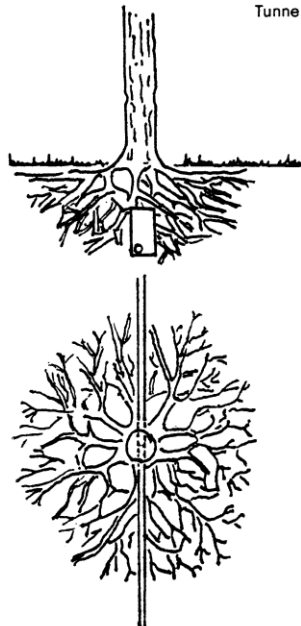

Utilities should be tunneled beneath tree roots. The drawings on the left show trenching that would probably kill the tree. The drawings on the right show how tunneling under the tree will preserve many of the important feeder roots.

Figure 9-6: Tree Protection - Underground Utility Installation

Tree Protection During Construction

Table 9-1:

Tree Characteristics ₁

SPECIES	ROOT SEVERENCE	SOIL COMPACTION & FLOODING	SOIL pH PREFERENCE	MATURE TREE HEIGHT (feet)	MATURE CROWN SPRED (feet)	HAZARD TREE RATING*	DAMAGE CAUSING ROOTS
Northern white cedar	Tolerant	Tolerant	6.0-8.0	40-50	10-20	Low	No
Balsam fir	Tolerant	Tolerant	4.0-6.0	40-60	20-35	Medium	No
White fir	Tolerant	Sensitive	4.0-6.5	50-75	10-20	Medium	No
Tamarack (Larch)	Tolerant	Tolerant	4.0-7.5	50-75	15-25	Medium	No
White pine	Tolerant	Sensitive	4.5-6.5	80-100	50-80	Medium	No
Jack pine	Tolerant	Sensitive	4.5-6.5	30-80	20-30	High	No
Red pine	Tolerant	Sensitive	4.5-6.0	50-80	20-40	Medium	No
Scotch pine	Tolerant	Sensitive	4.0-6.5	60-100	30-50	Medium	No
Eastern redcedar	Tolerant	Sensitive	4.7-7.8	40-50	10-20	Low	No
Black spruce	Tolerant	Tolerant	3.5-7.0	30-70	15-30	Medium	No
Colorado spruce	Intermediate	Tolerant	4.6-6.5	50-100	20-30	Medium	No
White spruce	Tolerant	Intermediate	4.5-7.5	40-80	20-30	Medium	No
Black ash	Tolerant	Tolerant	4.1-6.5	40-70	30-60	Medium	No
Green ash	Tolerant	Tolerant	6.0-7.5	30-60	30-50	Medium	No
White ash	Tolerant	Intermediate	5.0-7.5	70-80	50+	Medium	No
Bigtooth aspen	Tolerant	Sensitive	4.8-6.3	50-75	20-35	Medium	Yes
Trembling aspen	Tolerant	Sensitive	4.8-6.5	40-60	20-35	Medium	Yes
Blue beech	Sensitive	Sensitive	6.5-7.5	20-30	15-20	Low	No
Paper birch	Intermediate	Sensitive	5.0-8.0	50-70	30-50	Medium	No
River birch	Tolerant	Tolerant	4.0-6.5	40-70	30-50	Low	No
Yellow birch	Intermediate	Sensitive	4.5-8.0	50-70	50-70	Medium	No
Boxelder	Tolerant	Tolerant	6.5-7.5	40-60	35-50	High	Yes
Ohio buckeye	Intermediate	Intermediate	6.1-6.5	30-50	30-40	Medium	Yes
Butternut	Sensitive	Intermediate	6.6-8.0	40-60	50-60	Medium	No
Catalpa	Intermediate	Tolerant	6.1-8.0	50-80	30-50	Medium	No
Black cherry	Intermediate	Sensitive	6.0-7.5	50-70	40-50	Low	No
Kentucky coffeetree	Intermediate	Intermediate	6.5-7.5	50-80	40-50	Low	No
Eastern cottonwood	Tolerant	Tolerant	5.5-8.0	80-100	80-100	High	Yes
Red-osier dogwood	Tolerant	Intermediate	6.1-8.5	8-10	10-12	Low	No

SPECIES	ROOT SEVERENCE	SOIL COMPACTION & FLOODING	SOIL pH PREFERENCE	MATURE TREE HEIGHT (feet)	MATURE CROWN SPRED (feet)	HAZARD TREE RATING*	DAMAGE CAUSING ROOTS
American elm	Tolerant	Intermediate	5.5-8.0	70-100	70-150	Medium	Yes
Slippery elm	Tolerant	Intermediate	6.6-8.0	60-70	40-60	Medium	Yes
Hackberry	Tolerant	Intermediate	6.6-8.0	30-130	50+	Low	No
Hawthorn	Intermediate	Intermediate	6.0-7.5	20-40	20-30	Low	No
Bitternut hickory	Intermediate	Intermediate	6.0-6.5	40-75	30+	Medium	No
Honeylocust	Tolerant	Intermediate	6.0-8.0	50-75	50-75	Medium	Yes
Ironwood	Sensitive	Sensitive	6.1-8.0	25-50	20-30	Low	No
Basswood	Intermediate	Sensitive	5.5-7.3	70-100	50-75	High	No
Black locust	Tolerant	Sensitive	4.6-8.2	30-60	20-50	Medium	No
Red maple	Tolerant	Tolerant	4.5-7.5	50-70	40-60	Medium	Yes
Silver maple	Tolerant	Tolerant	5.5-6.5	60-90	75-100	High	Yes
Sugar maple	Intermediate	Sensitive	5.5-7.3	60-80	60-80	Medium	Yes
Mountain-ash	Tolerant	Intermediate	4.0-7.0	15-25	15-25	Medium	No
Black oak	Sensitive	Sensitive	6.0-6.5	50-80	50-70	Medium	No
Bur oak	Tolerant	Intermediate	4.0-8.0	70-80	40-80	Low	No
Pin oak	Sensitive	Sensitive	5.5-7.5	50-75	30-50	Medium	No
Red oak	Tolerant	Sensitive	5.5-7.5	50-75	30-50	Medium	No
Swamp white oak	Intermediate	Tolerant	6.0-6.5	60-70	40-50	Low	No
White oak	Sensitive	Sensitive	6.5-7.5	60-100	50-90	Low	No
Plum	Tolerant	Sensitive	6.5-6.6	20-25	15-25	Low	No
Serviceberry	Intermediate	Sensitive	6.5-6.6	20-25	15-25	Low	No
Black walnut	Sensitive	Intermediate	6.6-8.0	70-100	60-100	Medium	No
Black willow	Tolerant	Tolerant	6.5-8.0	30-60	20-40	High	Yes

Table 9.1:

* **Hazard tree rating:** refers to the relative potential for a tree to become hazardous. For a tree to be considered hazardous, a potential "target" (e.g., a house, a sidewalk, pedestrians) must be present. A high hazard tree rating does not imply that the tree will always fail.

1, *Protecting Trees from Construction Damage- A Homeowners Guide*, Gary R. Johnson, University Of Minnesota Extension Service, Saint Paul, MN, 1999.

**STANDARD
FOR
SELECTION OF TREES, SHRUBS
AND VINES FOR PLANTING**

Definition

Plants to aesthetically enhance and restore disturbed soils.

Water Quality Enhancement

Integrating trees, shrubs and vines with permanent turf grasses provides a protective vegetative cover against wind and rain, to minimize or negate water quality degradation downstream.

Where Applicable

Graded or cleared areas subject to erosion, where a permanent, long-lived vegetative cover other than turf alone is desired.

Plant Material

Although this is by no means a complete listing of the available plant material in these categories, it does include most of that which is commonly used throughout the State of New Jersey. The services of a Landscape Architect or a Horticulturalist should be utilized for the selection of plant material for specific sites where problems exist due to soil or other ecological conditions. See fig. 10-1, ATree Planting Detail@ for an example of a typical detail for tree establishment.

EVERGREEN TREES

Latin Name

Abies concolor
Ilex opaca
Juniperus virginiana
Picea abies
Picea pungens
Pinus strobus
Pinus thunbergi
Pseudotsuga menziesii

Common Name

White Fir
American Holly
Eastern Red Cedar
Norway Spruce
Colorado Spruce
White Pine
Japanese Black Pine
Douglas-fir

DECIDUOUS TREES

Latin Name

Acer rubrum & varieties
Acer saccharum
Aesculus hippocastanum
Carya ovata
Celtis occidentalis
Fagus grandifolia
Fagus sylvatica & varieties
Quercus alba
Quercus rubra

Common Name

Red Maple or Swamp Maple
Sugar Maple
Horsechestnut
Shagbark Hickory
Common Hackberry
American Beech
European Beech
White Oak
Northern Red Oak

Quercus coccinea	Scarlet Oak
Pin Oak	Quercus palustris
Quercus phellos	Willow Oak
Tilia americana	American Linden
Tilia cordata & varieties	Littleleaf Linden
Tilia tomentosa	Silver Linden
Zelkova serrata	Japanese Zelkova

SMALL DECIDUOUS TREES

Acer campestre	Hedge Maple
Acer ginnala	Amur Maple
Amelanchier canadensis	Shadblow Serviceberry
Betula varieties	Birch
Carpinus betulus	European Hornbeam
Carpinus caroliniana	American Hornbeam
Cercis canadensis	American Redbud
Cornus florida	Flowering Dogwood
Cornus kousa	Japanese Dogwood
Cornus mas	Cornelian Cherry Dogwood
Cotinus coggygria	Smokebush
Crataegus crusgalli	Cockspur Thorn
Crataegus phaenopyrum	Washington Hawthorn
Hibiscus syriacus	Shrub Althea
Magnolia virginiana	Sweetbay Magnolia
Malus varieties	Crabapples
Oxydendron arboreum	Sorrel Tree or Sourwood
Prunus varieties	Cherries
Salix caprea	Goat or Willow

SHRUBS

Latin Name	Common Name
Aronia arbutifolia	Red Chokeberry
Aronia arbutifolia brilliantissima	Brilliant Chokeberry
Chaenomeles lagenaria	Flowering Quince
Clethra alnifolia & varieties	Summersweet Clethra
Cornus varieties	Dogwood
Forsythia intermedia & varieties	Border Forsythia
Forsythia suspensa	Weeping Forsythia
Hamamelis varieties	Witchhazel
Ilex glabra	Inkberry
Ilex verticillata	Winterberry Holly
Kalmia latifolia	Mountain Laurel
Myrica pensylvanica	Northern Bayberry
Rhododendron maximum	Rosebay Rhododendron
Rhus varieties	Sumac
Rosa varieties	Rose
Salix discolor	Pussy willow
Syringa vulgaris	Common Lilac

Vaccinium corymbosum
Viburnum varieties

Highbush Blueberry
Viburnum

VINES AND PERENNIAL GROUND COVER

Campsis radicans
Euonymus fortunei vegetus
Juniperus conferta
Juniperus horizontalis plumosa
Pacysandra terminalis
Parthenocissus quinquefolia
Vitis sp.

Trumpetcreeper
Wintercreeper Euonymus
Shore Juniper
Andorra Juniper
Packasandra
Virginia Creeper
Grapes sp.

FIGURE 10-1: TYPICAL TREE PLANTING DETAIL

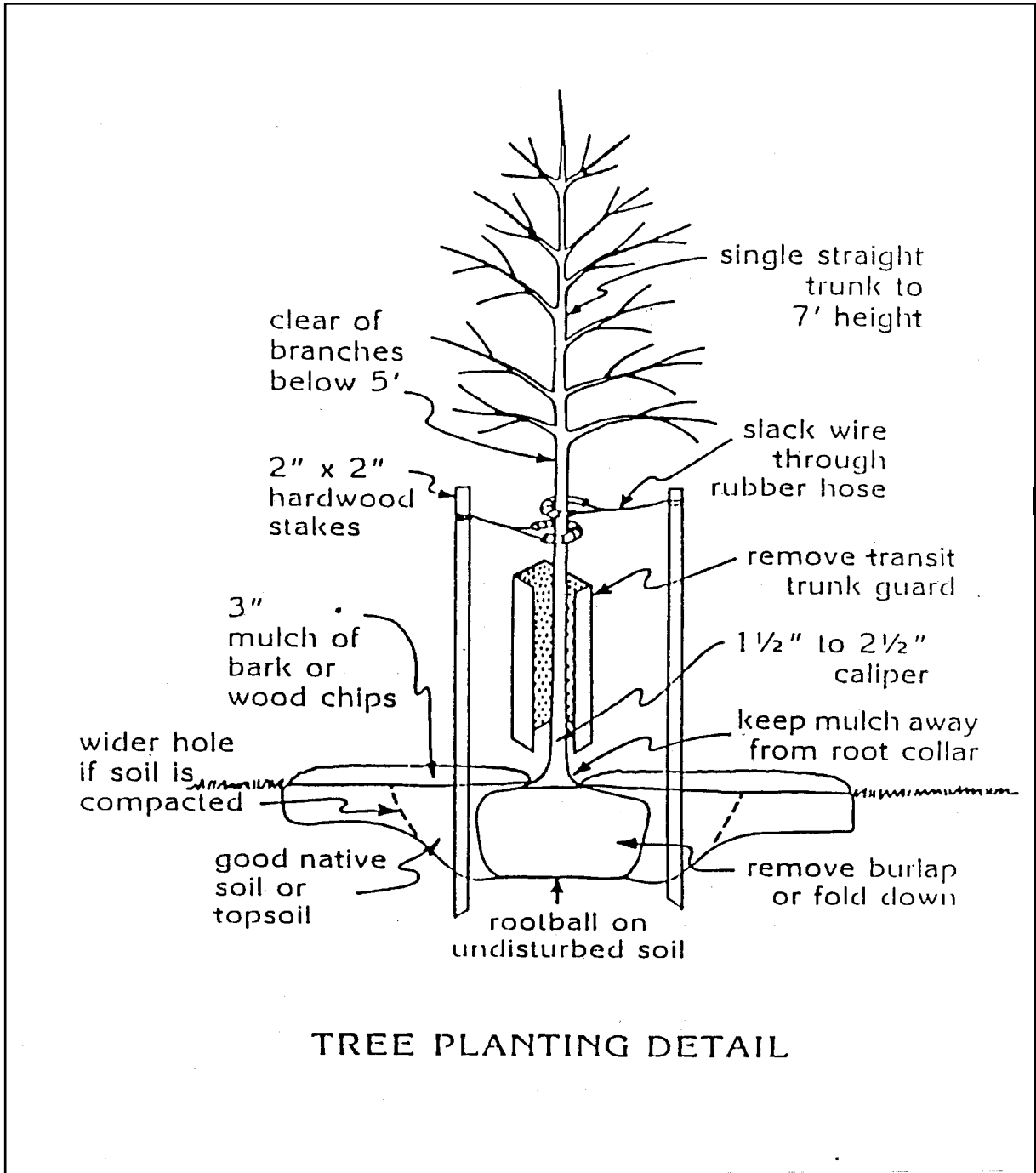

**STANDARD
FOR
CHANNEL STABILIZATION**

Definition

Stabilizing a channel, either natural or artificial, in which water flows with a free surface.

Purpose

Open channels are constructed or stabilized to be non-erodible and provide adequate capacity for the conveyance of flood water, drainage, other water management purposes or any combination thereof.

Conditions Where Practice Applies

This standard applies to the construction and stabilization of open channels for storm water conveyance and flood control and to the restoration of existing streams or ditches regardless of drainage area. It does not apply to diversions or grassed waterways.

Water Quality Enhancement

This standard seeks to produce a water conveyance channel which is characterized by natural features as much as possible while still incorporating engineered stability. This includes protection of existing vegetation and channel meander, rapid establishment of new stabilizing vegetation and design of new "natural" channel structures such as pools, riffles etc. Including these features helps promote low suspended solids, high dissolved oxygen levels and healthy macro invertebrate populations all of which are indicators of good water quality.

Design Criteria – Storm water conveyance and flood control channels

Planning

The alignment and design of channels shall involve giving careful consideration to the preservation of valuable fish and wildlife habitat. Trees of significant value for wildlife food or shelter shall be preserved whenever possible.

Where channel construction will adversely affect a significant fish or wildlife habitat, mitigation measures should be included in the plan. Mitigation measures may include pools, riffles, flats, cascades or other similar provisions.

As many trees as possible are to be left after considering the requirements for construction, operation and maintenance. See Standard for Tree Protection During Construction.

Realignment

The realignment of channels shall be kept to an absolute minimum.

Channel Capacity

The capacity for open channels shall be determined by the designer and/or the appropriate regulatory authority.

Capacity (peak discharge) shall be determined by the following methods:

1. Rational Method - for peak discharge of uniform drainage areas as outlined in Technical Manual for Stream Encroachment, Trenton, N.J., Bureau of Flood Plain Management,

2. USDA NRCS hydrologic procedures including WinTR55 and WinTR20.
3. U.S. Army Corps of Engineers HEC HMS
4. Other methods which produce similar results to the models listed above.

Hydraulic Requirements

Manning's formula shall be used to determine the velocities in the channels.

The "n" values for use in this formula shall be estimated using currently accepted guides along with knowledge and experience regarding the conditions.

Acceptable guides can be found in Appendix A11, Refs. 6, 7, and Appendix A8.

Every reach shall be individually designed unless all reaches are designed on the worst cases for velocity and capacity (lowest allowable velocity, steepest slope).

Channel Side Slopes

Channel side slopes in earth shall be 2:1 or flatter unless the design, using the procedures in Appendix A8, shows that a steeper side slope is stable. Channel side slopes of materials other than earth shall be designed stable.

Channel Stability (General)

All channel construction, improvement and modification shall be in accord with a design which results in a stable channel.

Characteristics of a stable channel are:

1. It neither aggrades nor degrades beyond tolerable limits.
2. The channel banks do not erode to the extent that the channel cross section is changed appreciably.
3. Excessive sediment bars do not develop.
4. Excessive erosion does not occur around culverts and bridges or elsewhere.
5. Gullies do not form or enlarge due to the entry of uncontrolled surface flow to the channel.

The determination of channel stability considers bankfull flow. Bankfull flow is defined as the flow in the channel which creates a water surface that is at or near normal ground elevation for a significant length of a channel reach. Excessive channel depth created by cut through high ground, such as might result from realignment of the channel, should not be considered in determinations of bankfull flow.

Channel Stability (drainage area of one square mile or less)

1. Permanent Channel

Channels in this category shall be considered stable if the actual velocity is less than the allowable velocities shown in Table 11-1. The actual velocity is defined as the velocity developed during the lesser of the following events:

- a. Bankfull discharge
 - b. 10-year frequency, storm, peak
2. Temporary (90 days or less) Bypass Channel

Channels in this category shall be considered stable if the actual velocity is less than the allowable velocities shown in Table 11-1. The actual velocity is defined as the velocity developed during the 2-year frequency peak discharge.

3. As a stable design, the channel shall meet the following allowable velocity criteria and shall not be designed above 90% of critical flow (Froude number = 0.90).

Table 11-1
Allowable velocity for various soil textures

SOIL TEXTURE	ALLOWABLE VELOCITY ft./sec.
Sand	1.8
Sandy loam	2.5
Silt loam, loam	3.0
Sandy clay loam	3.5
Clay loam	4.0
Clay, fine gravel, graded loam to gravel	5.0
Cobbles	5.5
Shale (non weathered shale)	6.0

Linear crossing of existing channels by pipelines and similar devices do not require a stability analysis of the channel provided the final cross sectional area of the stream remains the same.

Channel Stability (drainage area greater than one square mile)

Channels must be stable under conditions existing immediately after construction (as-built condition) and under conditions existing during effective design life (aged condition). Channel stability shall be determined for discharges under these conditions as follows:

1. As-built condition - Bankfull flow, design discharge, or 10-year frequency flow, whichever is smallest, but not less than 50% of design discharge.
2. Aged condition - Bankfull flow or design discharge, whichever is larger, except that it is not necessary to check stability for discharges greater than the 100-year frequency.

Stability checks are not required if the actual velocity is 1.8 fps or less.

Linear crossing of existing channels by pipelines and similar devices do not require a stability analysis of the channel provided the final cross sectional area of the stream remains the same.

Where vegetation can be rapidly established by natural or artificial means, the allowable as-built velocity (regardless of type stability analysis) in the newly constructed channel may be increased by a maximum of 20%. The 20%

adjustment does not apply to the allowable velocity for aged condition. This increase is justified only if:

1. The soil and site in which the channel is to be constructed are suitable for rapid establishment and support of erosion-controlling vegetation,
2. Species of erosion-controlling vegetation adapted to the area and proven methods of establishment are known, and
3. The channel design includes detailed plans for establishing vegetation on the channel side slopes.

For newly constructed channels in fine-grained soils and sands, the "n" values shall be determined according to specifications in Appendix A8 and shall not exceed 0.025. The "n" value for channels to be modified by clearing and de-snagging only shall be determined by reaches according to the expected channel condition upon completion of the work.

The above stability checks will be made using either tractive stress or allowable velocity procedures given in Appendix A8. The choice of method will depend upon the grain size and cohesiveness of the soil being checked. The following will be used as a guide in choosing the method:

- A. Tractive Stress - see Appendix A8
 1. Coarse grained soils
 2. Fine grained noncohesive soils (PI <10)
- B. Allowable Velocity - see Appendix A8
 1. Coarse grained soils (tractive stress procedure recommended)
 2. Fine grained cohesive soils (PI >10)
 3. Fine grained noncohesive soils (PI <10) (tractive stress procedure recommended)

Stability checks should be made for each significant soil horizon present. Soil sampling and testing is required to determine the grain size distribution and plasticity index of each material to be checked.

Channel Linings and Structural Measures

Where channel velocities exceed allowable velocities, the channel must be stabilized.

Channels may be stabilized by using one or more of the following methods:

1. Rock Riprap Lining shall be designed using the procedures given in Standard for Riprap, p. 23-1.
2. Concrete Lining shall be designed according to currently accepted guides for structural and hydraulic adequacy. They must be designed to carry the required discharge and to withstand the loading imposed by site conditions. Concrete lining shall be reinforced where required.
3. Grade Stabilization Structures can be used where excessive grades exist. The structures provide for one or more drops along the channel profile to reduce the channel slope. See Standard for Grade Stabilization

Structures.

The structures must be designed hydraulically to adequately carry the channel discharge and structurally to withstand loadings imposed by the site conditions. They may be constructed of concrete, rock, masonry, steel, gabions, aluminum or treated timber. Appendix A11, Chapter 6, Ref. #8, provides procedures for use in the design of these structures.

Energy Dissipaters are employed to force a hydraulic jump and its associated turbulence to occur at a location where suitable protection can be provided against bank scour and channel erosion. Construction of energy dissipaters are normally at the base of chutes or drop structures and are usually an integral part of the design of the structure. Sills, baffles, floor blocks or other obstructions to channel flow may serve as energy dissipaters. Appendix A11, Chapter 15, Ref. #6, provides design considerations for energy dissipation with the hydraulic jump.

4. Consideration may be given to the utilization of Soil Bioengineering techniques for channel stabilization. These techniques are not to be used when a structural design is required for safety, etc. See Standard for Soil Bioengineering for additional design guidance.

Design Criteria – Stream Restoration

Designs for stream restoration try to mimic natural conditions present in stable reaches proximate to the area to be treated. The extent of structural treatments beyond toe protection will be evaluated on a case by case basis. Generally, vegetative or bioengineering treatments (Soil Bioengineering) shall be used to stabilize low risk areas (agricultural, wooded, or other natural settings where there is little threat to adjacent structures or improvements. In high risk areas where there is significant threat of damage to physical improvements (homes, buildings, utilities, roadways, etc.) or to important cultural or environmental features, structural protection will be more appropriate.

A site assessment shall be performed to determine if the causes of instability are local (e.g. poor soils, high water table in banks, alignment, obstructions deflecting flows into bank, etc.) or systemic in nature (e.g. aggradation due to increased sediment from the watershed, increased runoff due to urban development in the watershed, degradation due to channel modifications, etc.). The assessment need only be of the extent and detail necessary to provide a basis for design of the treatments and reasonable confidence that the treatments will perform adequately for the design life of the measure.

In low risk areas treatments shall be evaluated under bankfull or ten-year return period (10 percent probability) flow conditions, whichever is less. High risk areas may require evaluations under less frequent flow events (up to a 100 year return period) depending on the value of the protected area. More frequent storm events should also be evaluated where these result in higher flow velocities.

Changes in channel alignment shall not be made without an assessment of both upstream and downstream fluvial geomorphology that evaluates the affects of the proposed alignment. The current and future discharge-sediment regime shall be based on an assessment of the watershed above the proposed channel alignment.

Bank protection treatment shall not be installed in channel systems undergoing rapid and extensive changes in bottom grade and/or alignment unless the treatments are designed to control or accommodate the changes. Bank treatment shall be constructed to a depth at or below the anticipated lowest depth of streambed scour.

Toe erosion shall be stabilized by treatments that redirect the stream flow away from the toe or by structural treatments that armor the toe. Additional design guidance is found in the National Engineering Handbook Part 654, Stream Restoration Design. Where toe protection alone is inadequate to stabilize the bank, the upper bank shall be

shaped to a stable slope and vegetated, or shall be stabilized with structural or soil-bioengineering treatments. Measures to redirect flow shall not reduce the flood carrying capacity of the stream nor cause adverse erosion or sedimentation elsewhere in the stream system. All treatments shall be stable under design flow conditions.

Where flooding is a concern, the effects of protective treatments shall not increase flow levels above those that existed prior to installation. When vegetative treatments are planned, flow levels shall be evaluated under mature growth conditions.

Installation Requirements

1. All trees, brush, stumps, and other objectionable materials that would interfere with the construction or proper functioning of the channel shall be removed.
2. Where possible, trees will be left standing, brush and stumps will not be removed and channels will be excavated from one side, leaving vegetation on the opposite side.
3. Construction plans will specifically detail the location and handling of spoils.
4. Seeding, fertilizing and mulching shall conform to the Standard for Permanent Vegetative Cover for Soil Stabilization.
5. Vegetation shall be established on all disturbed areas immediately after construction, weather permitting. If weather conditions are such as to cause a delay in the establishment of vegetation the area shall be mulched in accordance with the Standard for Stabilization with Mulch Only.

**STANDARD
FOR
CONDUIT OUTLET PROTECTION**

Definition

Conduit Outlet Protection consists of an erosion resistant section between a conduit outlet and a stable downstream channel.

Purpose

To provide a stable area at the outlet of a conduit in which the exit velocity from the conduit is reduced to a velocity consistent with a stable condition in the downstream channel.

Conditions Where Practice Applies

This practice applies to all conduit outlets. Conduit outlet protection is not needed if the design flow is not constricted by the conduit in the waterway or stream (top width in culvert equals normal flow top width in stream). Under this condition, transition areas such as at bridge or culvert abutments shall be armored up and downstream in accordance with the riprap standard. This includes areas in the immediate vicinity of the culvert which may be disturbed in order to facilitate the culvert installation.

Water Quality Enhancement

The use of this standard will protect the area immediately downstream of a conduit outlet from localized erosion in the form of scour, which is a common source of sediment in lakes and streams.

Design Criteria

Determination of Needs

The need for conduit outlet protection shall be determined by comparing the allowable velocity for the soil onto which the conduit is discharging to the velocity in the conduit. The allowable velocity for the soil shall be that given in Table 12-1, pg. 12-2. The velocity in the conduit shall be that which occurs during passage of the conduit design storm or the 25-year frequency storm, whichever is greater. When the velocity in the conduit exceeds the allowable velocity for the soil, conduit outlet protection will be used.

TABLE 12-1 ALLOWABLE VELOCITIES FOR VARIOUS SOILS

SOIL TEXTURE	ALLOWABLE VELOCITY (ft./sec.)
Sand	1.8
Sandy loam	2.5
Silt loam (also high lime clay), loam	3.0
Sandy clay loam	3.5
Clay loam	4.0
Clay, fine gravel, graded loam to gravel	5.0
Cobbles	5.5
Shale (non-weathered)	6.0

A. Horizontal Riprap Apron (fig. 12-1, 12-2)

Apron Dimensions – unconfined outlet

- The length and width of the apron shall be determined from the formulas:

$$TW < \frac{1}{2} D_o \quad La = 1.8 \left(\frac{q}{D_o^{0.5}} \right) + 7D_o \quad Wa = 3W_o + La$$

$$TW \geq \frac{1}{2} D_o \quad La = 3 \left(\frac{q}{D_o^{0.5}} \right) \quad Wa = 3W_o + 0.4La$$

$$\text{where } q = \frac{Q}{W_o}$$

Where D_o is the maximum inside culvert height in feet, W_o is the maximum inside culvert width in feet, q is the unit discharge, = Q/W_o in cfs per foot for the conduit design storm or the 25 year storm, whichever is greater and L_a is the length of the apron determined from the formula and W_o is the culvert width.

The width of the apron at the culvert outlet shall be at least 3 times the culvert width.

- Where there is a well-defined channel downstream of the apron, the bottom width of the apron shall be at least equal to the bottom width of the channel; and the structural lining shall extend at least one foot above the tailwater elevation but no lower than two-thirds of the vertical conduit dimension above the conduit invert.
- The side slopes shall be 2:1 or flatter.
- The bottom grade shall be 0.0% (level).
- There shall be no over fall at the end of the apron or at the end of the culvert.

B. Riprap

1. The median stone diameter, D_{50} , in feet, shall be determined from the formula:

$$\text{For Horizontal Apron: } d_{50} = \frac{0.02}{T_w} q^{1.33} \quad \text{where } q = \frac{Q}{W_o}$$

For areas where T_w cannot be computed, use $T_w = 0.2 D_o$

Where q and D_o are as defined under apron dimensions and T_w is tailwater depth above the invert of culvert in feet.

Preformed Scour Hole

Preformed scour holes may be utilized, as depicted in Figure 12-3 where conditions dictate the impractical use of flat aprons. The median stone diameter, D_{50} , in feet, shall be determined from the following formulas:

$$\text{where } Y = \frac{1}{2} D_o \quad d_{50} = \frac{0.0125}{T_w} q^{1.33}$$

$$\text{where } Y = D_o \quad d_{50} = \frac{0.0082}{T_w} q^{1.33}$$

$$Y = \text{depth of scour hole below culvert invert and } q = \frac{Q}{W_o}$$

The use of scour holes shall comply with county or local ordinances which would restrict the use of such devices due to possible problems with mosquito breeding.

Conduit Outlet Protection Design for Discharge into Detention Basins

Design of the median stone size for pipes discharging into a basin shall be based on one of the following methods:

1. Q shall be the 25 year storm discharge and T_w shall equal the 2 year storm elevation in the basin.
2. Analyze the hydraulic characteristics of the basin for the design storm to determine the combination of conduit discharge and tailwater that results in the largest required D_{50} stone size.

Downstream Protection

The conduit discharge shall not cause erosion in the downstream channel or aggravate conditions in the downstream channel. The designer shall furnish calculations to show that the conditions downstream will not be degraded as a result of the proposed construction (See Standard for Off-Site Stability, pg. 21-1)

Riprap Requirements

1. Fifty percent by weight of the riprap mixture shall be smaller than the median size stone designated as D_{50} . The largest stone size in the mixture shall be 1.5 times the D_{50} size. The riprap shall be reasonably well graded.
2. The thickness of riprap lining, filter and quality shall meet the requirements in the Riprap Standard pg. 22-2 & 22-3.
3. Properly designed concrete paving may be substituted for riprap.
4. Plastic-coated wire mesh stone-filled baskets or mattresses or concrete revetment blocks may be substituted for riprap if the D_{50} size calculated above is less than or equal to the thickness of the wire mesh structures or concrete revetment blocks. Design life of the wire mesh structures is estimated to be ten (10) years (minimum). Wire mesh baskets shall be filled with 4" to 7" angular shaped rock. For wire mesh "mattress" structures 3" to 4" stone may be used provided the mesh opening is small enough to contain the stone. Smaller stone will provide more stone "layers" in the mattress where larger stone would not sufficiently fill the structure's void space.

Figure 12-1 Configuration of Conduit Outlet Protection

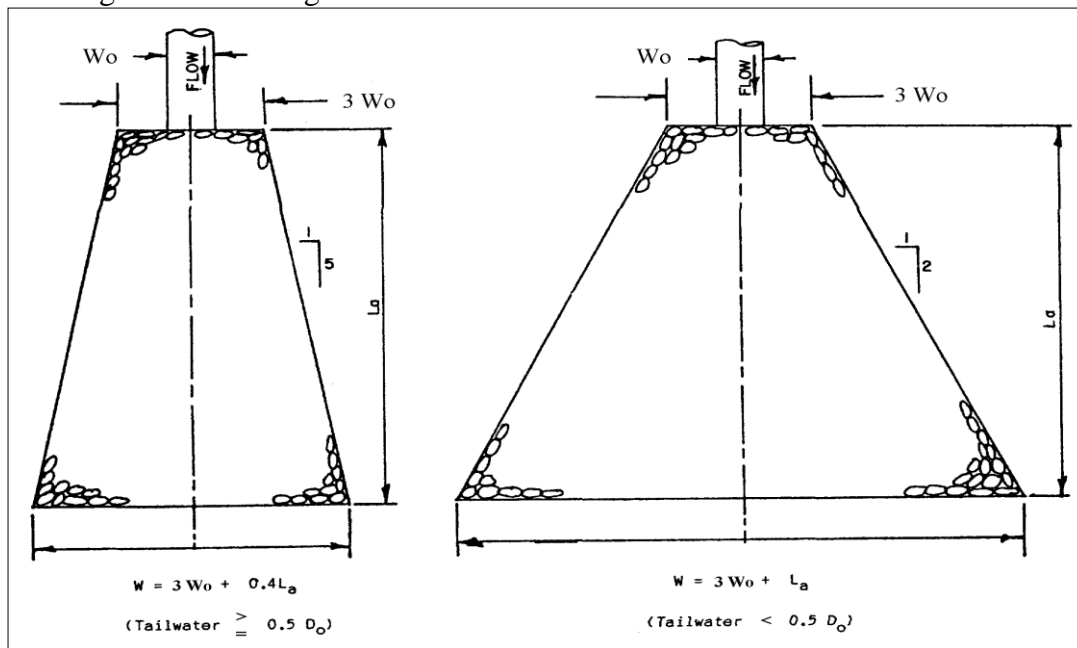
Installation Requirements

1. No bends or curves at the intersection of the conduit and apron or scour hole will be permitted.
2. There shall be no over fall from the end of the apron to the receiving channel.

Figure 12-2 Guidance for Multiple Culvert Outlets

All Culverts Same Diameter
Discharging Same Q

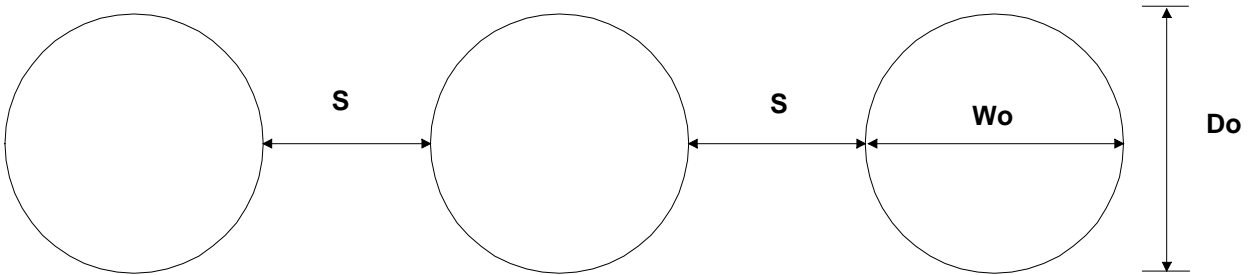

For $S < \frac{1}{4} W_o$ Size Riprap & Length for 1 pipe.
Width shall accommodate all culverts

For $S \geq \frac{1}{4} W_o$ Size Riprap & Length for 1 pipe and
increase values by 25 %

For culverts of varying diameters or discharge check riprap size and apron length for each. Use the largest values. Increase length and riprap values by 25% if spacing is greater than $\frac{1}{4} W_o$. Width shall accommodate all culverts.

References

Fletcher, B. P. and Grace, J. S. Jr., Practical Guidance For Estimating And Controlling Erosion at Culvert Outlets, 1972, Corps of Engineers Research Report H-72-5, Waterways Experimentation Station, Vicksburg, Mississippi

Figure 12-3 Configuration of Preformed Scour Hole

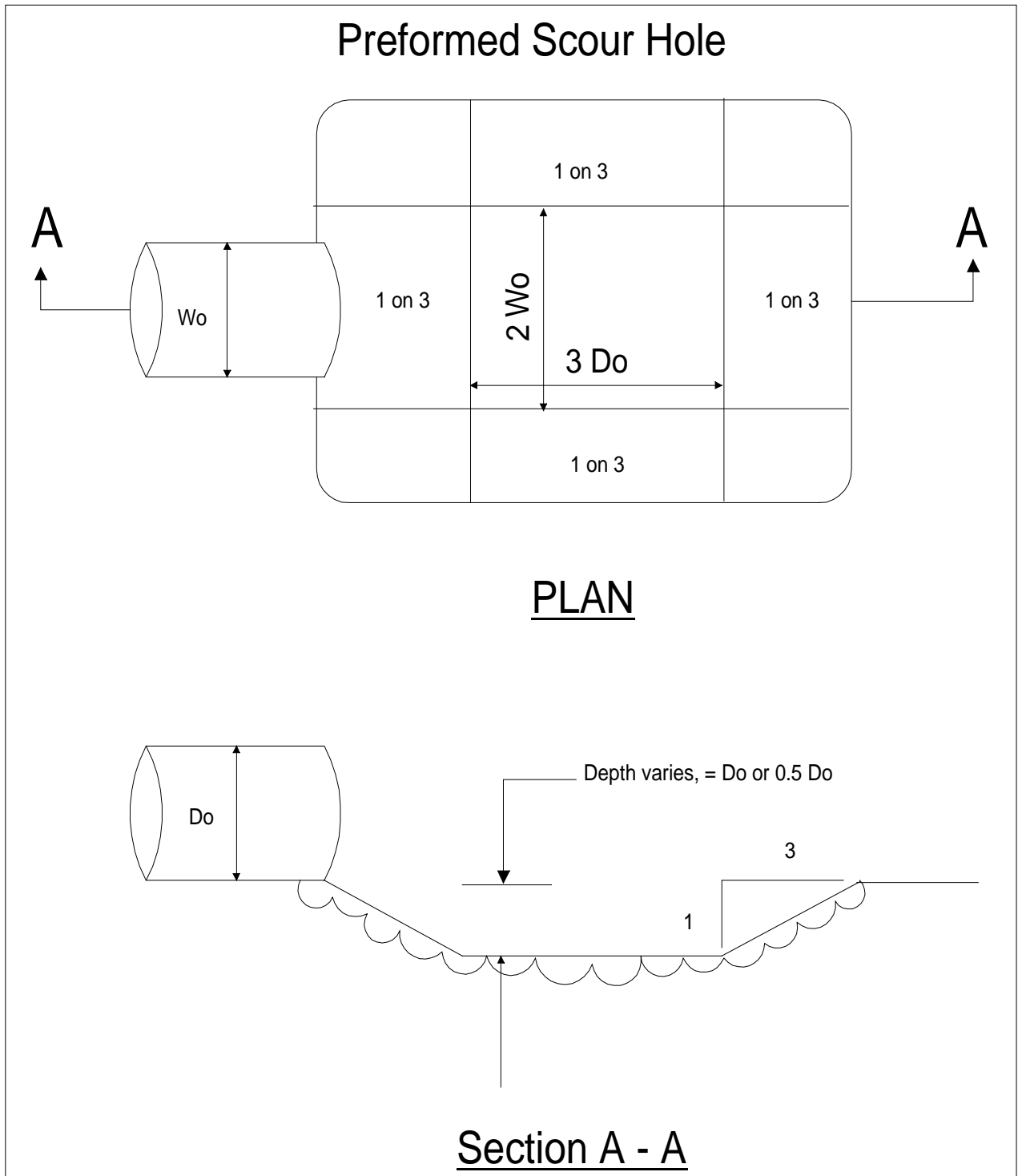

**STANDARD
FOR
DETENTION STRUCTURES
FOR CONTROL OF DOWNSTREAM EROSION**

Definition

A structure providing for temporary storage of stormwater runoff and its controlled release.

Structures created by construction of dams or barriers are referred to as "Embankment Structures" and those constructed by excavation as "Excavated Structures." Structures resulting from both excavation and embankment construction are classified as "Embankment Structures" where the depth of water impounded against the embankment at the emergency spillway elevation is 3 feet or more. Other forms of detention are also addressed in this standard such as rooftop and parking lot storage and underground detention systems.

Scope

This standard covers the installation of all detention, and infiltration / retention structures (those which retain a permanent pool of water below the design storm storage volume elevation).

Purpose

Detention structures are an available option to reduce erosion damages downstream by controlling the release from flows of predetermined frequencies. They may also permit the use of more economical channel improvements or stabilizing structures in the channel downstream and reduce environmental hazards and pollution.

Conditions Where Practice Applies

This practice applies if there is a potential for increased downstream erosion due to construction at development sites or from other land use changes or if local ordinances require storm detention structures. In general the practice applies to reducing the post development peak flows to 50% and 75% of predevelopment peak flows for the 2 and 10 year storms, respectively. The increased downstream erosion may be caused by increased runoff volume and/or increased peak discharge. If the detention structure is also intended to comply with the provisions of the Stormwater Management Act of 1981 or any revisions thereto, regulations promulgated by DEP pursuant to that Act shall apply. Additional design criteria required by the NJ Pinelands Commission may also apply.

Special consideration shall be given to the use of infiltration for peak flow modifications as follows:

Point of Discharge Stability Analysis

When infiltration practices are proposed, an alternate analysis (failure analysis) must be provided which ignores infiltration (no dead storage volume available, no static or dynamic infiltration loss rates in the routing calculations, etc) and demonstrates that no erosion will occur at the point of discharge if infiltration fails to function. Flow rates based solely upon basin inlet and outlet hydraulics must be used in comparison to Table 21-1 to document a stable outlet.

Downstream (off-site) Stability Analysis.

Infiltration may be used to meet peak flow reduction requirements (outlined above) for the purposes of documenting stability of the downstream receiving channel, provided that the complete loss of infiltration function does not result in an increase in peak flow values above the predevelopment levels.

Water Quality Enhancement

The use of a detention structure to control stormwater runoff may have several beneficial effects on water quality. First and foremost, control of small event storms will help prevent downstream erosion. Larger storms are managed to mitigate against flooding. By virtue of their ability to store runoff for a prolonged period, other effects such as deposition of suspended solids (including floatable trash and loose vegetation) and biochemical degradation of

fertilizers, pesticides and biosolids is also possible. Detention structure design and application should be predicated upon a watershed analysis (model) whenever possible to achieve the maximum benefit to stormwater management.

Design Criteria

Structural aspects of detention structures shall be as stipulated by applicable State requirements and are not regulated in this or other Standards. In the absence of such criteria Appendix A-10, Structural Guidelines for Detention Structures may be used. In Karst regions of the State, sufficient surface and subsurface investigations shall be conducted in order to identify the presence or absence of limestone within the reservoir and embankment area. Locations where sinkholes or solution channels are present or locations which have the potential for formation of these features, should be avoided. If alternate locations are not available, sealing or lining of the reservoir area may be required to prevent excessive seepage. See requirements under **Investigation, Design and Remedial Measures for Areas Underlain by Cavernous Limestone**, Appendix A10-19.

In addition it must be shown for the peak outflow as determined by the Modified Rational Method, USDA-NRCS Technical Release 55, Technical Release 20, USACOE - HEC HMS or other methods which produce similar results to these models, that there will be no soil erosion and sedimentation problems offsite. A detailed hydraulic analysis of the detention structure shall be submitted which will include an off site stability analysis pursuant to the Standard for Off-Site Stability, pg. 21-1. A completed Hydrologic Summary Form (Appendix A-2) shall be submitted to the district for each detention structure proposed.

Design Storms

The peak discharge from the 2-year and 10-year frequency storm shall be analyzed. Frequency, duration and distribution shall be as defined in the USDA-NRCS Technical Release 55.

Design storm and volume may be determined by the Modified Rational Method on drainage structures up to 20 acres as described in Special Report 43 by the American Public Works Association, Practices in Detention of Urban Stormwater. This method is not recommended for analysis of sites with sensitive off-site areas. If there is an overall storm water management plan for the watershed that considers erosion, downstream peak flow increases that are compatible with the overall plan may be allowed. Note - more restrictive stormwater management regulations may be required by other state or local agencies.

Outlets for Conduits

Protection against scour at the discharge end of the spillway shall be provided in accordance with the Standard for Conduit Outlet Protection or by suitable hydraulic structures proven effective by properly documented research.

Outlets discharging into structures shall also be designed in accordance with the Standard for Conduit Outlet Protection.

Vegetation

The dam, emergency spillway, spoil, borrow areas and other disturbed areas above the crest of the principal spillway shall be vegetated in accordance with the Standard for Permanent Vegetative Cover for Soil Stabilization. All cut or fill slopes should be flat enough to accommodate the proposed operation and maintenance equipment.

Safety

Detention structures attract children and can be very dangerous. Local, county or state regulations regarding health and safety must be adhered to.

This portion of the Standard is for guidance only.

Ownership

Ownership and responsibility for operation and maintenance of the detention structure must be determined during design and shown on the plans and on the completed "Hydraulic and Hydrologic Data Base Summary Form" (Appendix A2). To be effective over a long period of time the structure must be properly maintained.

This portion of the Standard is for guidance only.

Operation and Maintenance - General

A detailed schedule of operation and maintenance should be prepared for use by the owner or others responsible for the structure to insure that the structure functions properly. This schedule should provide requirements for at least annual inspection, operation, and maintenance of individual components, including outlets. It should be prepared during design and should specify who is responsible for maintenance. Additional requirements of other state and local agencies may apply.

Underground Facilities

Underground detention facilities shall be designed to prevent failure due to internal or external pressures including hydrostatic uplift pressure and imposed surface loads such as vehicles operated on or adjacent to the detention facility. Criteria for structural design are outside the scope of this standard. Structural design criteria must be based on sound and accepted engineering practices.

In acid or sulfidic soils, materials shall be non-reactive with the soil or measures shall be taken to protect the facility from the soil. Provisions shall be made to prevent debris from entering the facility. Debris collectors shall be placed so that the need for maintenance can be readily detected and cleaning operations easily performed. The bottom of the facility shall be on a slight grade to insure complete drainage. Access must be provided to the facility to permit removal of sediment and other debris.

Soil Conservation Districts are responsible for the enforcement of operation and maintenance of stormwater management facilities during construction for the control of erosion and sedimentation only. Once a Final Certificate of Compliance has been issued by the district proper operation and maintenance becomes the responsibility of the entity designated on the plans and schedule.

**STANDARD
FOR
DEWATERING**

Definition

The removal and discharge of sediment-laden water from an excavated area, construction site or sediment basin.

Purpose

To properly remove suspended sediments and water from excavated areas through filtration and/or settlement prior to discharging water to a receiving water course or body.

Conditions Where Practice Applies

During construction excavated facilities need to be dewatered to facilitate or complete the construction process. The water pumped out of the excavated areas contain sediments that must be removed prior to discharging to receiving bodies of water. This standard does not address the removal of ground water through well points etc.

This standard describes the following practices for the removal of sediment laden waters from excavation areas: removable pumping stations, sump pits, portable sedimentation tanks and silt control bags.

Water Quality Enhancement

Water discharged from excavated areas on construction sites may be a significant contributor of sediment to surface waters during construction. Water must be removed and disposed of in order for construction to move forward. Typically, water is pumped or containment berms are breached and sediment laden waters are permitted to flow uncontrolled into surface waters such as streams or lakes. By employing practices described in this standard, the majority of sediment suspended in waters may easily be removed prior to leaving the site. Filters and materials described herein are readily available and are easy to install and maintain.

Design Criteria

1. Removable Pumping Stations are used when long durations of pumping are required. The number of removable stations and their locations shall be shown on the plans and shall conform to detail 14-1. Water pumped from the station shall be discharged into a sediment basin or suitable filter area.

Construction Specifications

- A. The suction hose from the pump shall be placed inside the inner pipe to begin dewatering. The discharge hose shall be placed in a stabilized area downslope of unstabilized areas to prevent erosion.
- B. Maintenance- The inner pipe can easily be removed to facilitate changing the geotextile when it clogs. Maintenance must be performed when the pump runs dry and backed up water remains.
- C. See Detail 14-1 for additional specifications.

Detail 14-1 Removable Pumping Station

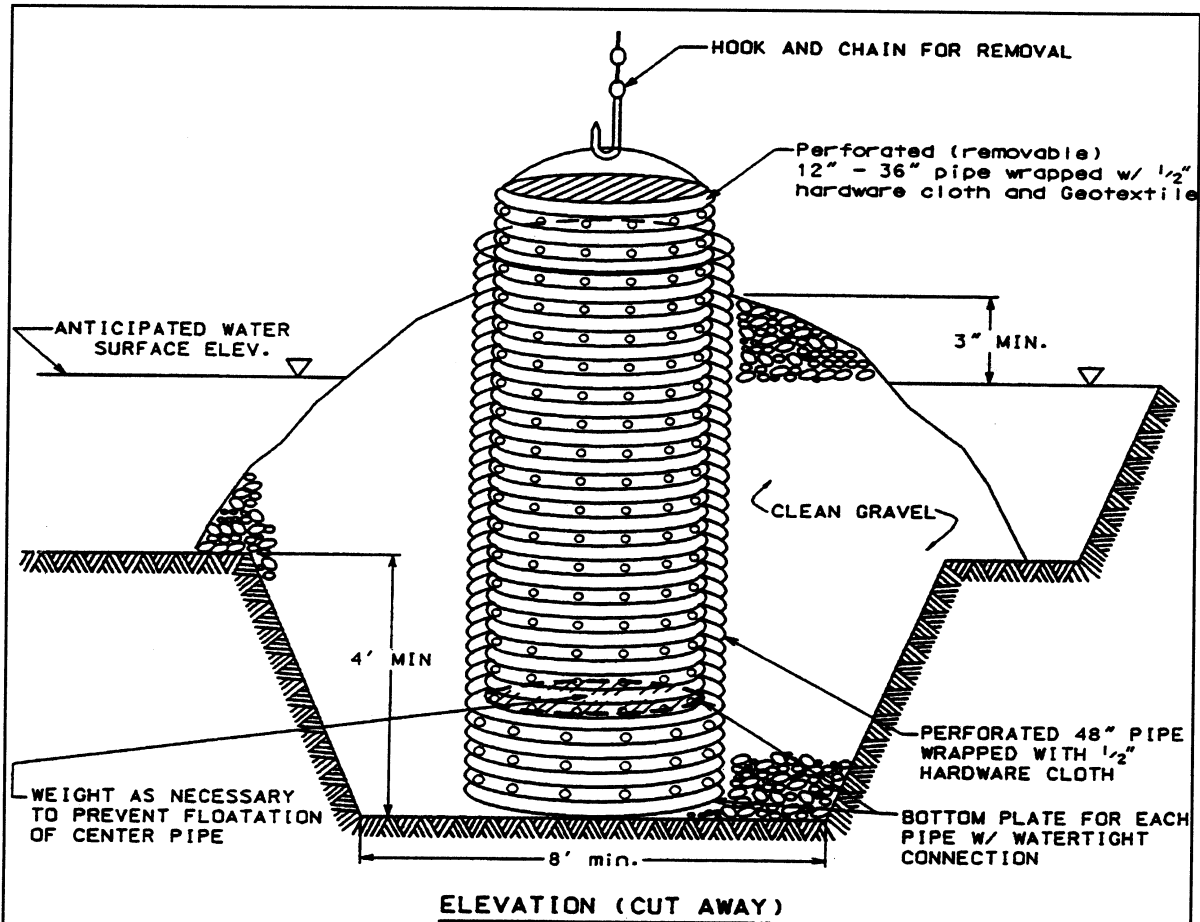

Construction Specifications

1. The outer pipe should be 48" dia. or shall, in any case, be at least 4" greater in diameter than the center pipe. The outer pipe shall be wrapped with $\frac{1}{2}$ " hardware cloth to prevent backfill material from entering the perforations.
2. After installing the outer pipe, backfill around outer pipe with 2" aggregate or clean gravel.
3. The inside stand pipe (center pipe) should be constructed by perforating a corrugated or PVC pipe between 12" and 36" in diameter. The perforations shall be $\frac{1}{2}$ " X 6" slits or 1" diameter holes 6" on center. The center pipe shall be wrapped with $\frac{1}{2}$ " hardware cloth first, then wrapped again with Geotextile Class E.
4. The center pipe should extend 12" to 18" above the anticipated water surface elevation or riser crest elevation when dewatering a basin.

Source: USDA NRCS 1994

2. **Sump Pits** are temporary pits which are used to remove excess water while minimizing sedimentation. The number of sump pits and their locations shall be included on the plans. Pits may be relocated to optimize use but discharge location changes must be coordinated with the local conservation district. The design must conform to the general criteria outlined on detail 14-2.

A perforated vertical standpipe is wrapped with 2" hardware cloth and geotextile fabric then placed in the center of an excavated pit which is then backfilled with filter material consisting of anything from clean gravel (minimal fines) to ASTM C 33 stone (1 2" maximum diameter). Water is then pumped from the center of the standpipe to a suitable discharge area such as into a sediment basin or suitable filter.

Detail 14-2: Sump Pit

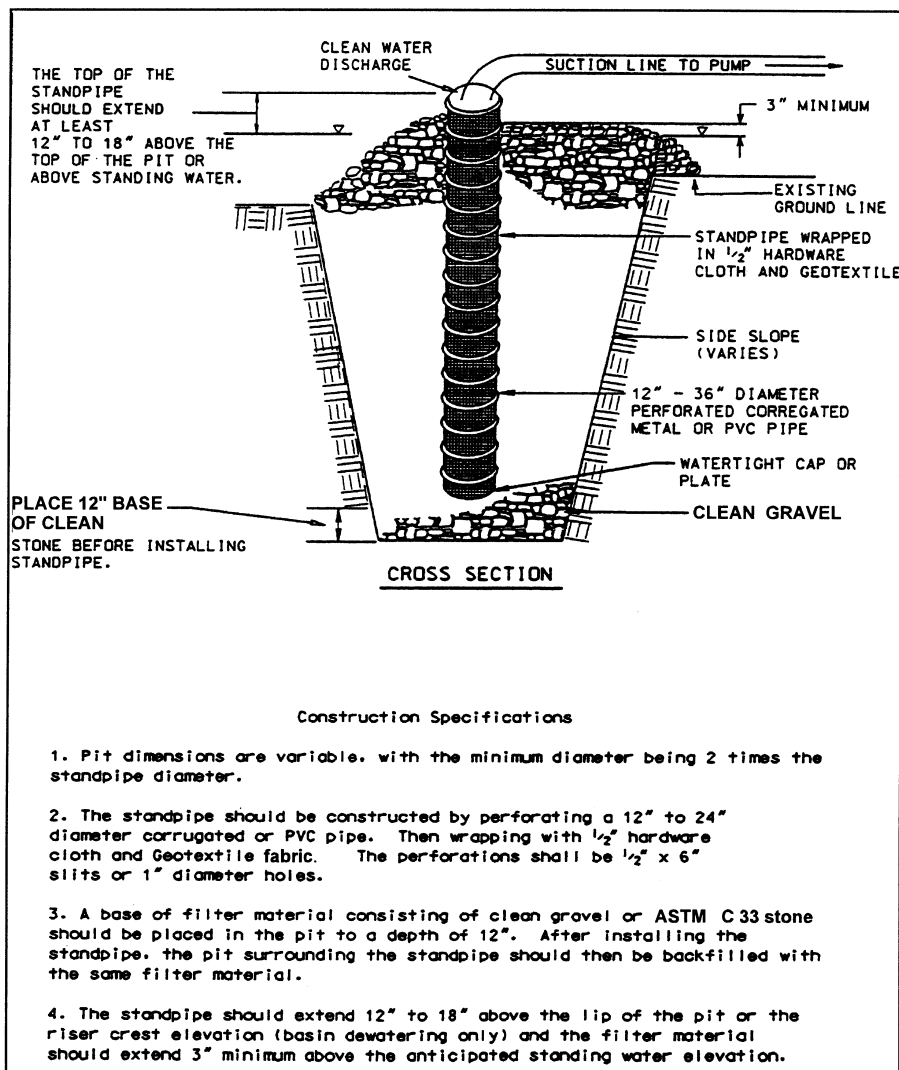

Source: USDA NRCS 1994

Detail 14-3 Portable Sediment Tank

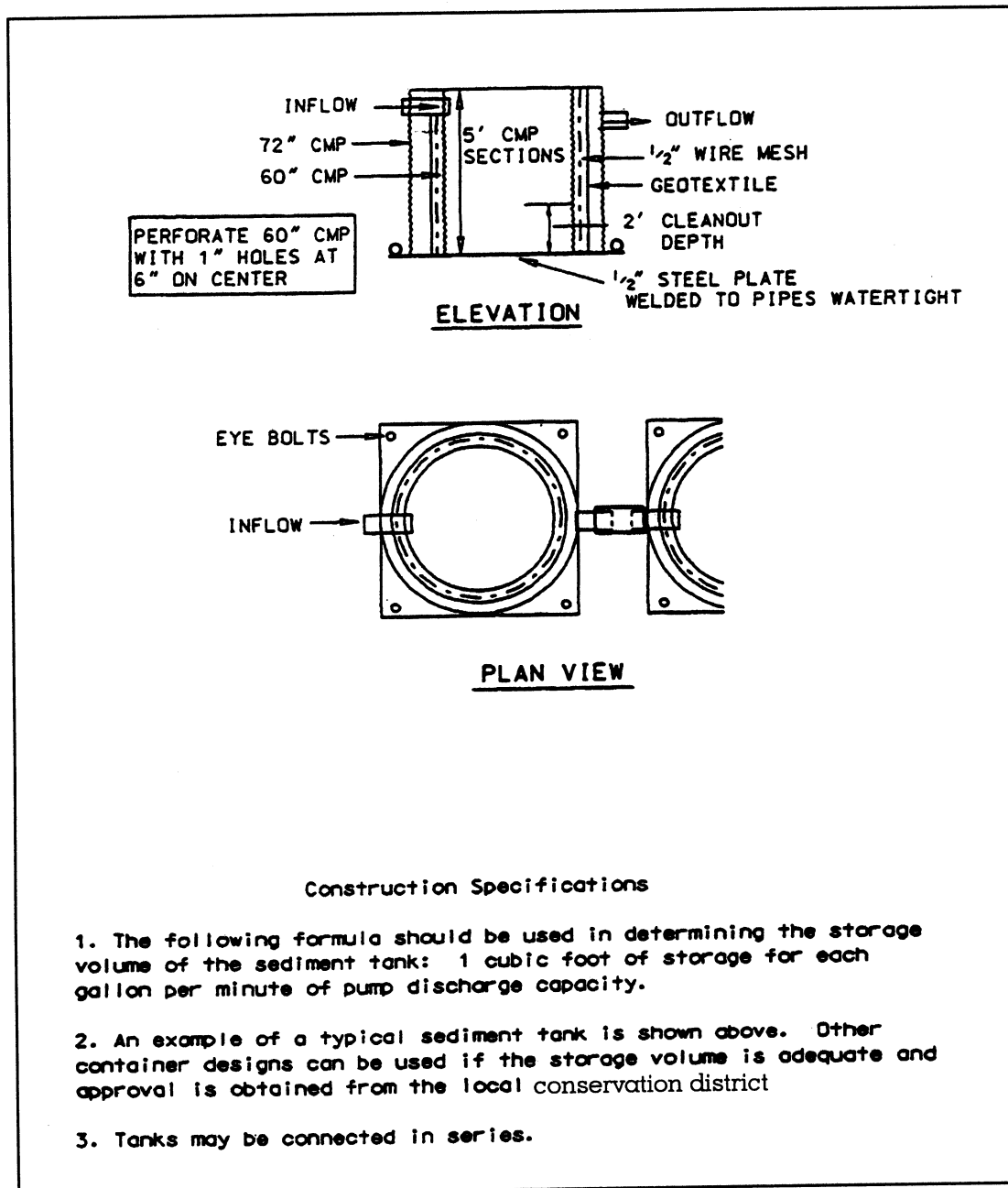

Source: USDA NRCS 1994

3. Sediment Tank / Silt Control Bags are containers through which sediment laden water is pumped to trap and retain the sediment. A sediment tank or a silt control bag is to be used on sites where excavations are deep, and space is limited and where direct discharge of sediment laden water to stream and storm drainage systems is to be avoided.

Construction Specifications

- A. Location. Containers (tanks or bags) shall be located for ease of clean-out and disposal of the trapped sediment and to minimize interference with construction activities and pedestrian traffic. Bags shall not be placed directly into receiving waters.
- B. Tank size. The following formula should be used in determining the storage volume of the tank: 1 cubic foot of storage for each gallon per minute of pump discharge capacity. Typical tank configuration is shown on Detail 14-3. Tanks may be connected in series to increase effectiveness.
- C. Tanks consist of two concentric circular pipes (CMP), attached to a watertight baseplate. The inner CMP is perforated with 1" holes on 6" centers and is wrapped with geotextile and hardware cloth. Pumped water is discharged into the inner CMP where it flows through the geotextile into the space between the two CMPs. A discharge line is attached to the outer CMP and draws filtered water from the annulus between the two concentric CMPs. The discharge line may be connected to another tank where it drains to the inner CMP of the second tank. This series connection may be continued indefinitely.
- D. Sediment Control Bags must be located away from receiving waters and disposed of according to manufacturer's instructions. See Detail 14-4. Bags may be combined with temporary filters (item 4, following) for enhanced filtration.
4. Temporary filters for small impoundments For small quantities of ponded water such as may be found in shallow excavations (small trenches, manhole installations etc.) a sediment filter may be constructed using combinations of hay bales, small clean stone and filter fabric. This method is limited to small quantities of trapped surface water (pumping of well points is excluded from this standard) and where sediments are not highly colloidal in nature.

Detail 14-4 Sediment Control Bag for Dewatering

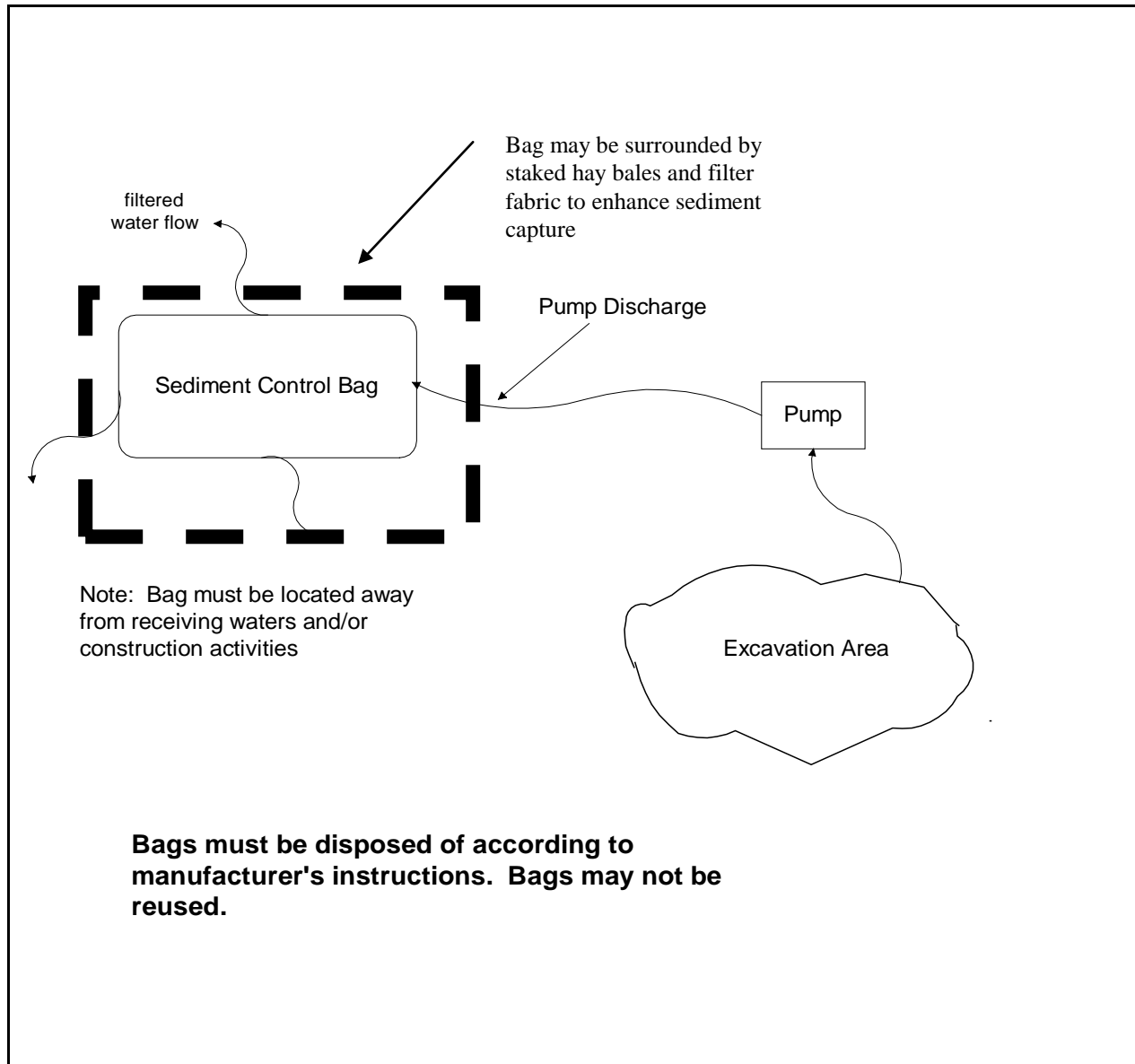

**STANDARD
FOR
DIVERSIONS**

Definition

A channel with a supporting ridge on the lower side constructed across the slope.

Scope

This standard covers the installation of diversions with drainage areas up to 100 acres.

Temporary

Diversions installed as an interim measure to protect or facilitate some phase of construction. They usually have a life expectancy of one year or less. The failure hazard is low.

Permanent

Diversions installed as an integral part of an overall water management and disposal system and to remain for protection of property.

Purpose

The purpose of this practice is to divert water from areas where it is in excess to sites where it can be used or disposed of safely.

Conditions Where Practice Applies

This practice applies to sites where runoff is damaging: (1) low lying areas, (2) cut or fill slopes or steeply sloping land, (3) critical sediment source areas in construction sites, (4) buildings, residences, streets and (5) active gullies or other erodible areas.

Permanent diversions are not applicable below high sediment producing areas unless land treatment practices or structural measures, designed to prevent damaging accumulations of sediment in the channels are installed with or before the diversions.

Water Quality Enhancement

The primary benefit to water quality is through the prevention of erosion of lands with large drainage areas or steep slopes. Diversions control and direct stormwater runoff to stable locations, thus preventing the development of erosive forces which result not only in soil loss, but the transportation of associated soil nutrients, fertilizers, pesticides etc. into surface and possibly ground water resources.

Design Criteria

Capacity and Freeboard

Peak discharge values shall be determined by the following:

1. Rational Method - for peak discharge of uniform drainage areas as outlined in Technical Manual for Land Use Regulation Program, Bureau of Inland and Coastal Regulations Stream Encroachment Permits, Trenton, N.J.

September 1997 or subsequent editions.

2. USDA-NRCS Win TR-55 or Win TR-20.
3. U.S. Army Corps of Engineers HEC HMS
4. Other methods which produce similar results to the models listed above.

The minimum size shall be that required to confine the peak runoff from the design storm plus required freeboard. The design storm and freeboard shall comply with the following table:

Table 15-1 Temporary and Permanent Diversion Sizing

Diversion Type	Typical Area of protection	Design Storm Frequency	Freeboard Required (ft)
Temporary	Construction Areas (structures, roads, pipelines, etc.)	2 years	0.0
	Building Sites	5 years	0.0
Permanent	Agricultural Land	25 years	0.3 ft.
	Urban Land Areas, Play Fields, Recreation Areas, Agricultural Buildings, etc.	25 years	0.3 ft
	Homes, schools, industrial buildings, etc.	50 years	0.5 ft

General Notes

1. Diverted runoff shall outlet onto an undisturbed stable area or onto an area that has been stabilized.
2. Periodic inspection and required maintenance must be provided.

Velocity

The maximum permissible velocity for design flow will be determined by the most erodible soil texture exposed and the type of vegetation expected and maintained in the channel. As a stable design, the diversion shall meet the following permissible velocity criteria and shall not be designed above 90% of critical flow (Froude number = 0.90). The following table will be used in selecting maximum permissible velocities:

Table 15-2 Maximum Permissible Velocity by Soil Type

SOIL TEXTURE	Maximum Permissible Velocity (ft./sec.) (velocities based on flow of clear water.)		
	Channel Vegetation		
	Non-Veg.*	Veg.**	Sod***
Sand	1.8	2.0	3.0
Silt loam, sandy loam, loamy sand, loam, and muck	2.0	2.0	3.0
Silty clay loam, sandy clay loam	2.0	2.5	4.0
Clay, clay loam, sandy clay, silty clay	2.5	3.0	5.0

* Temporary Diversions

** Vegetated Channels - The minimum capacity and maximum velocity shall be determined by using the appropriate retardance factors listed below. See Appendix A6 for example and charts for use in design. Maximum allowable velocities for channels stabilized by seeding may be increased according to the type of Flexible Channel Liner used as shown in the Standard for Grassed Waterways. These velocities may be added to the allowable velocities shown above, except for sands.

Agricultural Handbook No. 667, Stability Design of Grass-Lined Open Channels, may also be used to design grass lined diversions based on tractive stress.

*** On well to excessively drained soils, the use of most cool season sod types will not survive without continued irrigation. Placement of sod in such areas must be approved by the District.

Permanent Cover and Erosion Protection

A permanent vegetative cover shall be established on all diversions in accordance with the Standard for Permanent Vegetative Cover for Soil Stabilization, or Standard for Permanent Stabilization with Sod. Where the season and other conditions may not be suitable for growing permanent erosion resistant cover, erosion protection will be provided in accordance with the Standard for Temporary Vegetative Cover for Soil Stabilization, or Standard for Stabilization with Mulch Only.

Diversions that are not designed to have a permanent vegetative cover shall be designed for bare channel velocities and with flat side slopes to prevent channel and side slope erosion. Diversions that are designed to have a permanent vegetative cover shall be seeded from the toe of the back slope to the upstream side of the designed channel width plus any required filter strip. Other areas disturbed by diversion construction shall also be seeded.

Vegetative Retardance Factors

Minimum Capacity - "D"

Maximum Allowable Velocity - "E"

Tables to select channel dimensions are available in Chapters 7 and 9, Ref. #1, appendix A-11

Bare Channels - The minimum capacity and maximum velocity shall be determined by using Manning's formula with an "n" value of 0.025.

Cross Section

The shape of the channel cross section shall be such that the diversion can be properly maintained with modern equipment. The channel may be parabolic, vee-shaped or trapezoidal.

The side slopes for permanent diversions shall not be steeper than 3:1 for maintenance purposes and preferably 4:1. Where frequent crossings are expected, slopes should be flatter. The back slope of the ridge is not to be steeper than 3:1 and preferably 4:1. The ridge shall include a settlement factor equal to 5 percent of the height. **The minimum top width of the diversion ridge after settlement is to be 4.0 feet at the design water elevation.**

In determining the cross section for temporary diversions, consideration should be given to soil type, frequency of operation and type of equipment that is anticipated to be crossing the diversion. In no case shall slopes be steeper than 1.5:1.

The top of the constructed ridge shall not be lower at any point than the design elevation plus the specified overfill for settlement.

Profile(s) and cross-section(s) of all channel diversions shall be submitted on the Soil Erosion and Sedimentation Control Plan.

Location

Diversion location shall be determined by outlet conditions, topography, land use, soil type and length of slope. Consideration must be given to the effects caused by changing natural water courses and putting additional flow into a water course.

Spacing on Slopes

To prevent surface runoff on slopes from exceeding the maximum sheet flow threshold distance (100 feet as defined by USDA-NRCS TR-55), spacing between multiple diversions on slopes will be **no greater than 33 vertical feet or 100 horizontal feet**. Diversions utilized on landfill slopes shall incorporate a drainage network of diversions running parallel to the slope to control runoff from very large or steep landfill caps. All diversions shall outlet into a properly designed chute which shall safely convey runoff to a stable location or other stormwater control structure. Care must be taken to prevent subsurface percolation and flow beneath the chute.

Grade

Diversion channel grade may be uniform or variable. Uniform grades are normally better. The allowable velocity for soil type and vegetative cover will determine maximum grade. Diversions with blocked ends may be used provided adequate pipe outlets are installed. If grade is to vary then each section must be individually designed.

Protection Against Sedimentation

When the movement of sediment into the diversion channel is a significant problem:

1. Land treatment or structural measures shall be installed to stabilize the source of sediment or trap the sediment.
2. If it is not possible to stabilize or trap the sediment, a filter strip of close growing grass shall be maintained above the diversion channel. The filter strip width measured from the center of the channel shall be at least

one-half the channel top width plus 15 feet.

Outlet

Each diversion must have an adequate, stable outlet. The outlet may be: a grassed, stone centered or lined waterway; a vegetated or paved area; a grade stabilization structure; a storm sewer; a stable watercourse; a tile outlet; or open channel.

The outlet in all cases, must be stable and convey water to a disposal point where damage will not result.
Constructed vegetative outlets must be established prior to diversion construction.

Temporary Stone Outlet Structure

A temporary stone outlet structure (Fig. 15-1 & 2) for a diversion may be used only where the contributing watershed is less than five acres. **The minimum length, in feet, of the crest of the stone outlet structure shall be equal to six times the number of acres of the contributing drainage area.** The crest of the stone outlet structure shall be level and at least six inches lower than the lowest elevation of the top of the diversion. The stone shall be crushed stone and be 4" to 8" in diameter except for a one-foot thick blanket of 2" diameter stone on the upstream face.

The temporary stone outlet structure shall be located so as to discharge onto an already stabilized area or into a stable watercourse. The stone structure shall be embedded into the soil a minimum of four inches.

Installation Requirements

All trees, brush, stumps or other objectionable material shall be removed so they will not interfere with construction or proper functioning of the diversion. All ditches or gullies which must be crossed, will be filled and compacted prior to, or as part of the construction. Fence rows and other obstructions that will interfere with construction or the successful operation of the diversion are to be removed.

Vegetation is to be removed and the base for the ridge thoroughly disked before placement of fill.

The minimum constructed cross-section is to meet the design requirements.

The top of the constructed ridge is not to be lower than the design elevation plus the specified amount for settlement. Fertilizing, seeding and mulching shall conform to the requirements in the Standard for Permanent Vegetative Cover for Soil Stabilization.

If there is no sediment protection provided on temporary diversions it should be anticipated that periodic cleanout may be required.

Construction operations shall be carried out in such a manner that erosion and air and water pollution will be minimized. State and local laws shall be complied with.

Figures 15-1 & 15-2: Outlet Structure Cross Section and Profile

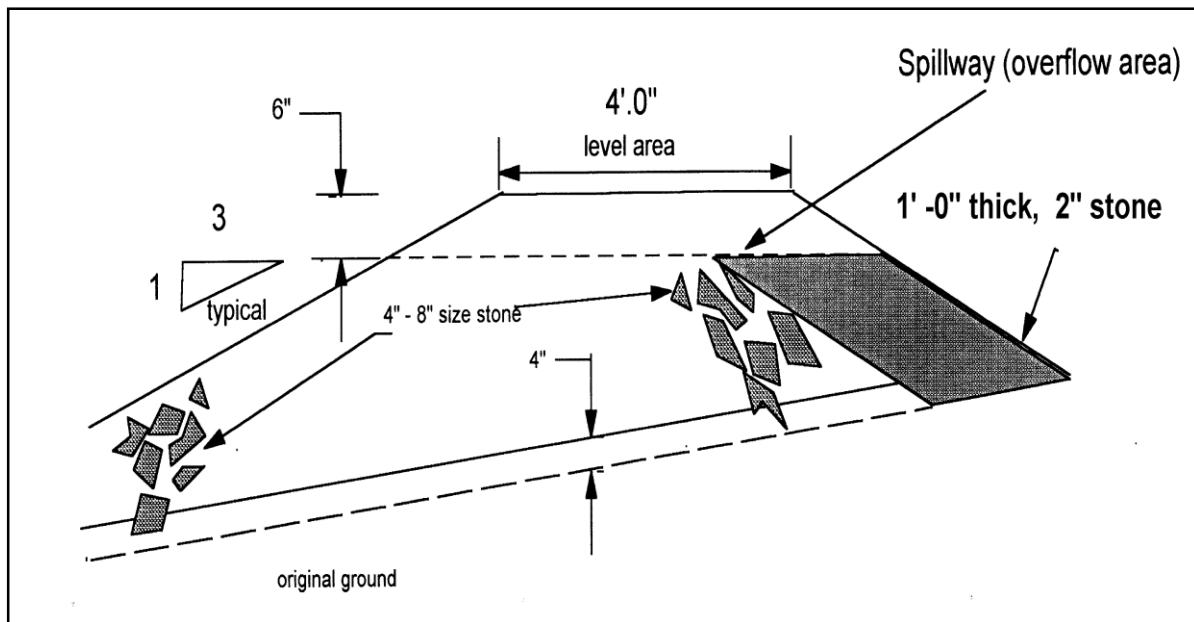
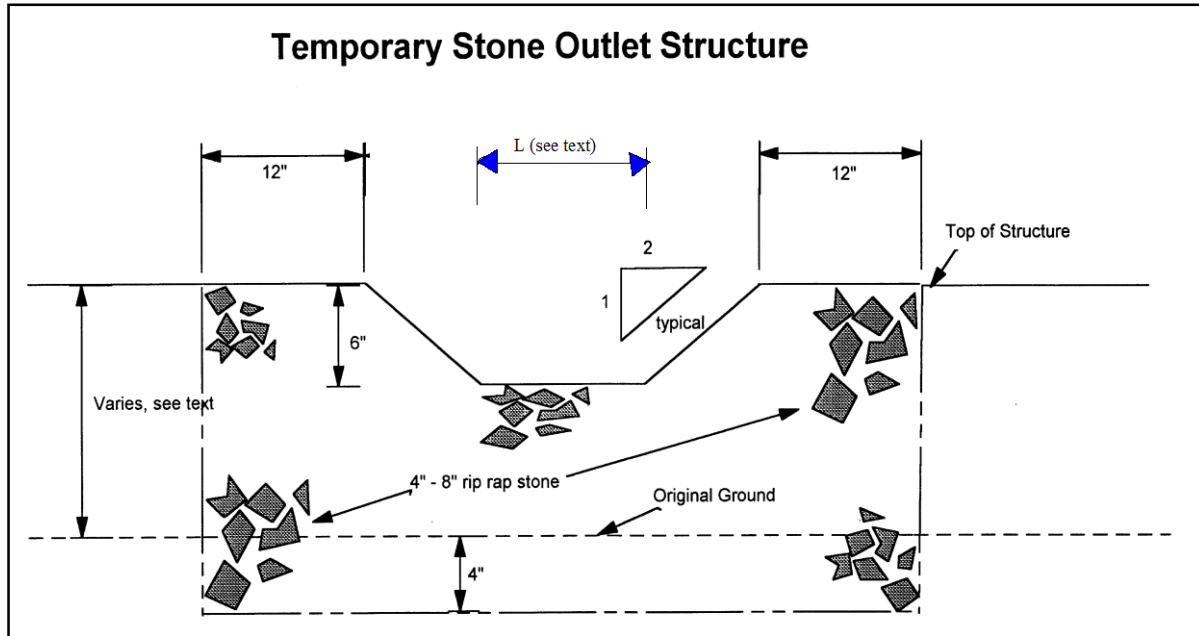

Roadbed Diversions.

Where the diversion will be temporarily used to direct water off a graded right of way onto stable areas (Figure 15-3), and the only area draining toward the diversion is the roadbed itself, the following spacing and size may be used instead of preparing individual designs for each diversion.

Table 15-3 Roadbed Diversion Spacing by Slope

Road Grade (percent)	Approximate Distance Between Diversions (ft)	Road Grade (percent)	Approximate Distance Between Diversions (ft)
1	400	15	60
2	245	20	50
5	125	25	40
10	80	30	35

Design Criteria:

- parabolic section
- 2 cfs or less flow rate
- 1% slope (grade) on diversion
- Top width: 12 feet
- Depth: 0.6 feet (0.5' depth + 0.1' settlement), no freeboard

Figure 15-3: General layout of roadbed diversions

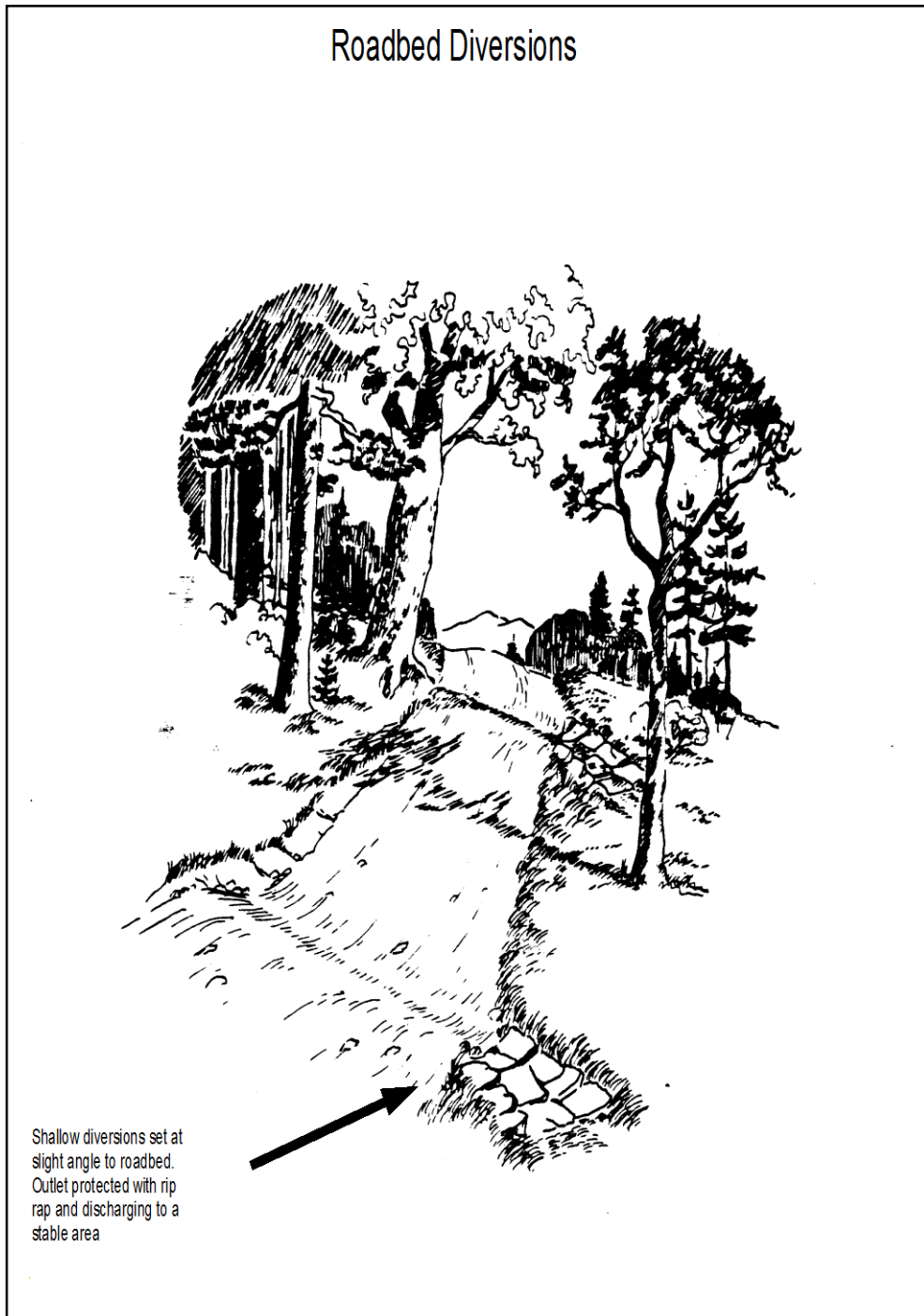

**STANDARD
FOR
DUST CONTROL**

Definition

The control of dust on construction sites and roads.

Purpose

To prevent blowing and movement of dust from exposed soil surfaces, reduced on-site and off-site damage and health hazards and improve traffic safety.

Condition Where Practice Applies

This practice is applicable to areas subject to dust blowing and movement where on-site and off-site damage is likely without treatment. Consult with local municipal ordinances on any restrictions.

Water Quality Enhancement

Sediments deposited as “dust” are often fine colloidal material which is extremely difficult to remove from water once it becomes suspended. Use of this standard will help to control the generation of dust from construction sites and subsequent blowing and deposition into local surface water resources.

Planning Criteria

The following methods should be considered for controlling dust:

Mulches - See Standard of Stabilization with Mulches Only, pg. 5-1

Vegetative Cover - See Standard for: Temporary Vegetative Cover, pg. 7-1, Permanent Vegetative Cover for Soil Stabilization pg. 4-1 and Permanent Stabilization with Sod, pg. 6-1

Spray-On Adhesives - On mineral soils (not effective on muck soils). Keep traffic off these areas.

Table 16-1 Dust Control Materials

MATERIAL	WATER DILUTION	TYPE OF NOZZLE	APPLY GALLONS/ACRE
Anionic asphalt emulsion	7:1	Coarse Spray	1200
Latex emulsion	12.5:1	Fine Spray	235
Resin in water	4:1	Fine Spray	300
Polyacrylamide (PAM) - spray on Polyacrylamide (PAM) - dry spread	Apply according to manufacturer's instructions. May also be used as an additive to sediment basins to flocculate and precipitate suspended colloids. See Sediment Basin standard, p. 26-1		
Acidulated Soy Bean Soap Stick	None	Coarse Spray	1200

Tillage - To roughen surface and bring clods to the surface. This is a temporary emergency measure which should be used before soil blowing starts. Begin plowing on windward side of site. Chisel-type plows spaced about 12 inches apart and spring-toothed harrows are examples of equipment which may produce the desired effect.

Sprinkling - Site is sprinkled until the surface is wet.

Barriers - Solid board fences, snow fences, burlap fences, crate walls, bales of hay and similar material can be used to control air currents and soil blowing.

Calcium Chloride - Shall be in the form of loose, dry granules or flakes fine enough to feed through commonly used spreaders at a rate that will keep surface moist but not cause pollution or plant damage. If used on steeper slopes, then use other practices to prevent washing into streams or accumulation around plants.

Stone - Cover surface with crushed stone or coarse gravel.

**STANDARD
FOR
GRADE STABILIZATION STRUCTURES**

Definition

A structure (drop, chute, etc) to control the grade and head cutting in natural or artificial channels.

Scope

This standard applies to all types of grade stabilization structures. It also applies to structures installed to lower the water from a surface drain or a waterway to a deeper channel to control erosion, head cutting or channel grade. It does not apply to structures designed to control the rate of flow or to regulate the water level in channels.

Purpose

To stabilize the grade and control erosion in natural or artificial channels, to prevent the formation or advance of gullies and to reduce environmental and pollution hazards.

Conditions Where Practice Applies

This standard applies to areas where the concentration and flow velocity of water requires structures to stabilize the grade or to control gully erosion in channels. Special attention shall be given to maintaining or improving habitat for fish and wildlife and to maintaining or improving the natural stream flow characteristics, where applicable.

Water Quality Enhancement

Use of this standard will help prevent and control degradation of the interior surfaces of waterways both in man-made and natural channels which in turn will reduce the amount of sediment carried by the channel to receiving waterways.

Design Criteria

Structures

The structure must be designed so that it is stable after installation. The crest of the inlet must be set at an elevation that stabilizes the upstream channel. The outlet must be set at an elevation level that results in a stable structure. Structures must not create unstable conditions upstream or downstream.

Structure Embankments

Embankments used with structures must meet the following requirements:

Foundation - The area on which an embankment is to be placed shall consist of material that has sufficient bearing strength to support the embankment without excessive consolidation.

Top width - The minimum top width shall be as follows:

Embankment Height and Top Widths

TOTAL HEIGHT OF EMBANKMENT (feet)	TOP WIDTH (feet)
up to 20	10
20 - 24	12

Side slopes - The combined upstream and downstream side slopes of the settled embankment shall not be less than five horizontal to one vertical, with neither slope steeper than 2:1. Slopes must be designed to be stable in all cases, even if flatter side slopes are required.

Freeboard - The minimum elevation of the top of the settled embankment shall be 1.0 feet above the maximum water surface upstream during the total capacity design storm.

Settlement - The design height of the embankment shall be increased by the amount needed to insure that after all settlement has taken place, the height of the embankment will equal or exceed the design height. This increase shall not be less than 5%, except where detailed soil testing and laboratory analysis shows a lesser amount is adequate.

Length - If natural ground elevation is used for an emergency spillway, the constructed top elevation of the embankment shall extend at least 40 feet in both sides of the structure.

Structure Spillways

Chute and drop spillways shall be designed according to the principles set forth in the Engineering Field handbook for Conservation Practices, The National Engineering Handbook and other applicable USDA-NRCS publications and reports.

Entrances to chutes and drop spillways will be protected against the force of flowing water at the interface between the structure's entrance walls and the earthen embankment. Acceptable methods include rip rap and keying of the entrance walls into the embankment. Channels must **not** enter these structures at an angle where energy will be dissipated in a bend.

The minimum capacity shall be that required to pass the peak flow expected from a design storm of the frequency and duration shown in Table 17-1 or 17-2, as applicable, less any reduction because of detention storage.

Full flow structures are structures where the structure spillway plus an emergency spillway, if used, carry all the flow from the watershed. Typical full flow structures are drop spillways and rock chutes.

Island structures are structures where flows larger than the structure spillway design flow spread out, and the larger flows are not significantly carried by the structure spillway. Typical island structures are pipe drop and hooded inlets.

TABLE 17-1 MINIMUM CAPACITY OF FULL-FLOW STRUCTURES

DRAINAGE AREA (acre)	VERTICAL DROP (feet)	MINIMUM DESIGN STORM		
		STRUCTURE SPILLWAY CAPACITY FREQUENCY (year)	TOTAL CAPACITY FREQUENCY (year)	MINIMUM DURATION (hour)
250 or less	5 or less	5	10	24
500 or less	10 or less	10	25	24
all other	all other	25	100	24

TABLE 17-2 MINIMUM CAPACITY OF ISLAND STRUCTURES

DRAINAGE AREA (acre)	VERTICAL DROP (feet)	MINIMUM DESIGN STORM		
		STRUCTURE SPILLWAY CAPACITY FREQUENCY (year)	TOTAL CAPACITY FREQUENCY (year)	MINIMUM DURATION (hour)
250 or less	5 or less	1	10	24
500 or less	10 or less	1	25	24
all other		1 year or channel design capacity, whichever is higher	50	24

Total Capacity Design Storm

All structures shall have the capacity to pass the peak flow expected from the minimum design storm for total capacity in Tables 17-1 and 17-2, as applicable, less any reduction because of detention storage. This may be accomplished by using a structure spillway or a combination of structure spillway and emergency spillway. There shall not be damage to or erosion of the structure spillway or emergency spillway during passage of the total capacity design storm. Water flowing through an emergency spillway during the total capacity design storm must re-enter the channel without erosion.

Emergency spillways may use natural ground or be constructed. Minimum design flow depth for natural ground emergency spillways is 0.3 feet.

Toe Wall Drop Structures

Toe wall drop structures may be used if the vertical drop is 4 feet or less, flows are intermittent and downstream grades are stable.

Road Culvert Box Inlets

The minimum capacity of drop boxes to culverts shall be as specified in Tables 17-1 or 17-2, as applicable or as required by the responsible road authority, whichever is greater.

Figure 17-1 : Schematic of Drop Grade Structure
(Source: USDA- NRCS)

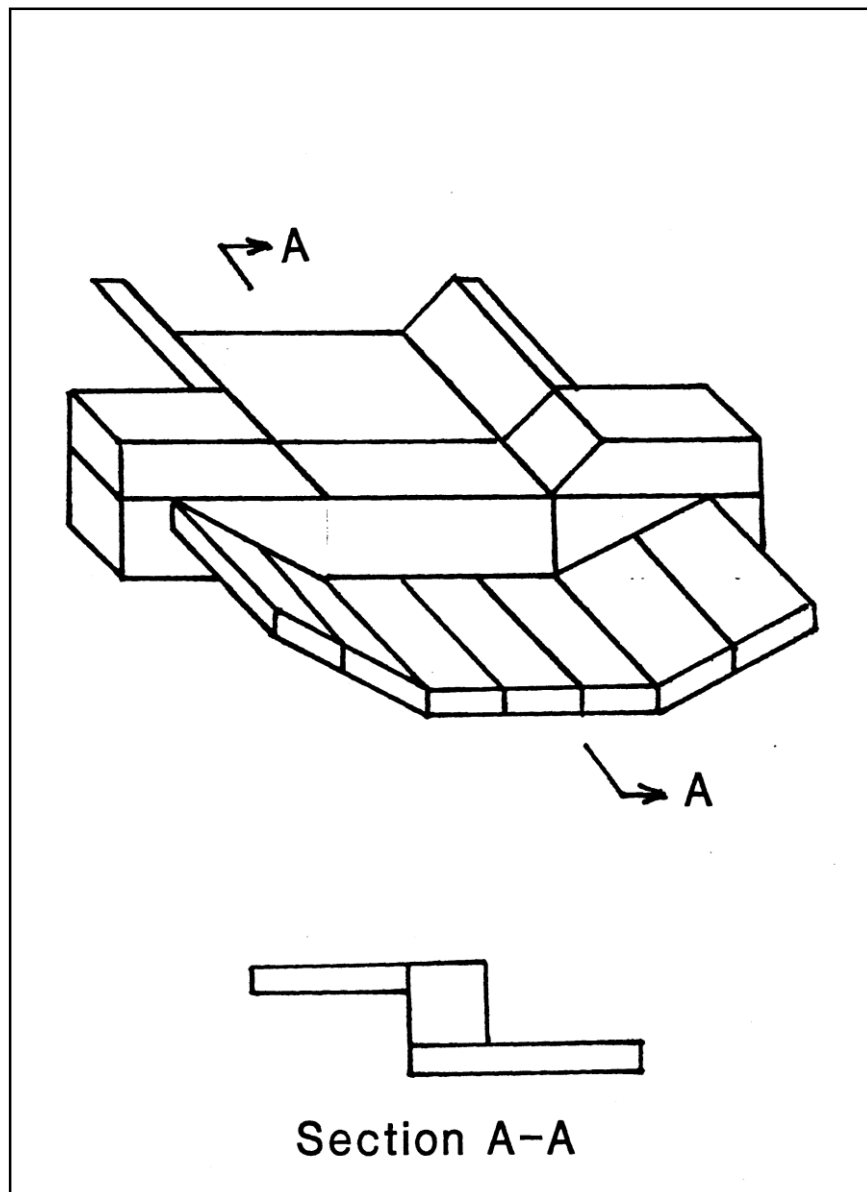

STANDARD FOR GRASSED WATERWAYS

Definition

A natural or constructed watercourse shaped or graded in earth materials and stabilized with suitable vegetation for the safe conveyance of runoff water.

Purpose

To provide for the conveyance of excess surface water without damage by erosion or flooding.

Conditions Where Practice Applies

This practice applies to sites with drainage areas less than 200 acres where concentrated runoff requires vegetative protection or stone center lining to control erosion. Slope of waterway must be less than 10%. Some of the other practices that may be required with this practice are: (1) grade control structures, (2) subsurface drainage to permit the growth of suitable vegetation and to eliminate wet spots, (3) a section stabilized with stone or other material within the waterway or (4) buried storm drain to handle frequently occurring storm runoff, base flow or snowmelt. This practice is not appropriate when maintenance of the grass lining cannot or will not be performed.

Water Quality Enhancement

Use of this standard will provide protection of the waterway lining from the erosive forces of flowing water. Additionally, stormwater runoff quality may be enhanced through adsorption and infiltration (absorption) of minor suspended solids and associated pollutants, such as excess fertilizers and pesticides, hydrocarbons and through bacterial degradation of biosolids. Minor groundwater recharge may also be provided. The total effect on water quality is limited by higher flow velocities and concentrated flows in the waterway. Swales should not be depended upon to provide the sole means of improving runoff water quality. They should be used in conjunction with other erosion control practices listed in these standards, whenever possible.

Design Criteria

Capacity

Peak discharge values shall be determined by the following:

1. Rational Method - for peak discharge of uniform drainage areas as outlined in Technical Manual for Land Use Regulation Program, Bureau of Inland and Coastal Regulations Stream Encroachment Permits, Trenton, N.J. September 1997 or subsequent editions.
2. USDA-NRCS Win TR- 55 or Win TR-20.
3. U.S. Army Corps of Engineers HEC HMS
4. Other methods which produce similar results to the models listed above.

Minimum capacity and maximum velocity shall be based on the 10 year frequency storm, unless a larger storm event is to be conveyed for reasons of safety, compatibility with other stormwater management measures etc.

Velocity

The maximum allowable velocity for design flow will be determined by the most erodible soil texture exposed and the type of vegetation expected and maintained in the channel. As a stable design the waterway shall meet the following allowable velocity criteria and shall not be designed within 10% of critical flow (Froude number = 0.90).

Table 18-1 Maximum Allowable Velocities by Soil Texture

SOIL TEXTURE	Maximum Allowable Velocity (fps)	
	Seeded Vegetation**	Sod***
Sand	2.0	3.0
Silt loam, sandy loam, loamy sand, loam, muck	2.0	3.0
Silty clay loam, sandy clay loam	2.5	4.0
Clay, clay loam, sandy clay, silty clay	3.0	5.0

Maximum Allowable Velocities are based on flow of clear water.

** Maximum allowable velocities for channels stabilized by seeding may be increased according to the type of Flexible Channel Liner used as shown in the following table. These velocities may be added to the allowable velocities shown above, except for sands.

***On well to excessively drained soils, most cool season sod types will not survive without continued irrigation. Placement of sod in such areas must be approved by the District.

Table 18-2 Classification of Flexible Channel Liners by Texas DOT

"Class 2" Flexible Channel Liner Designation ¹	Allowable Shear Stress ² (psf)	Incremental increase in velocity (fps)
Type "E"	0 to 2	1.0
Type "F"	0 to 4	1.5
Type "G"	0 to 6	2.0
Type "H"	0 to 8	3.0
Type "I"	0 to 10	4.0
Type "J"	0 to 12	5.0

¹ Designations defined by Texas Department of Transportation Hydraulics and Erosion Control Laboratory Field Performance Testing of Selected Erosion Control Products (as amended or most current) Evaluation Cycle

² Typically refers to maximum stress with a fully vegetated matting

There shall be no increase in allowable velocity beyond that indicated for sod if the design life of the flexible channel liner is less than the planned service life of the grassed waterway.

Vegetative Retardance Factors and Manning's "n" Value

The minimum capacity and maximum velocity shall be determined by using the appropriate vegetative retardance factors listed below. Appendix A2 contains examples and charts for use in design. Agricultural Handbook No. 667, Stability Design of Grass-Lined Open Channels, may also be used to design grass waterways based on tractive stress.

Vegetative Retardance Factors

Minimum for Capacity - "D"

Maximum for Allowable Velocity - "E"

Tables to select channel dimensions are available in Appendix A11, Ref. #1, Chapter 7.

Dimensions

The dimensions of the waterway will be based on: (1) the minimum required for capacity, the channel slope, the maximum permissible velocity, the vegetation, the soil; (2) ease of crossing and maintenance; and (3) site conditions such as water table, depth to rock or possible sinkholes.

The minimum top width of a waterway will be 10 feet. The maximum design top width shall not exceed 50 feet.

The minimum design flow depth shall be sufficient to completely submerge the vegetative lining during the design flow (consideration may be given to expected mature height undergoing deflection during flow or an artificially maintained height) such that uniform flow characteristics are achieved. Design flow depths which are less than the lining height may tend to produce meandering and erosion in the waterway bottom and will not be accepted.

The cross section may be parabolic, vee-shaped, or trapezoidal. Cross-section(s) and profile(s) of all grassed waterways shall be submitted on the Soil Erosion and Sedimentation Control Plan.

Drainage

In areas with low flow, high water table or seepage problems, underdrains, stone centers or other subsurface drainage methods are to be provided. A minimum drainage coefficient of ½ inch in 24 hours is to be used for underdrain design. An open joint storm drain may be used to serve the same purpose and also handle frequently occurring storm runoff, base flow or snowmelt. The storm drain shall be designed to handle base flow, snowmelt or the runoff from at least a one-year frequency storm, whichever is greater.

Design of Stone Center lining for wet or low flow conditions:

Where a stone lining is needed due to seepage, low flow, high water table, etc., stone size shall be based on the maximum design flow (10 year storm event minimum) to be conveyed and shall be installed to a depth equal to the design flow depth for a 1 year, 24 hour storm. The stone shall be **EMBEDDED FLUSH** with the waterway surface.

The following nomograph may be used to determine the D_{75} stone size for the center lining:

Nomograph to Compute Stone Size for Grass Waterway Center Lining

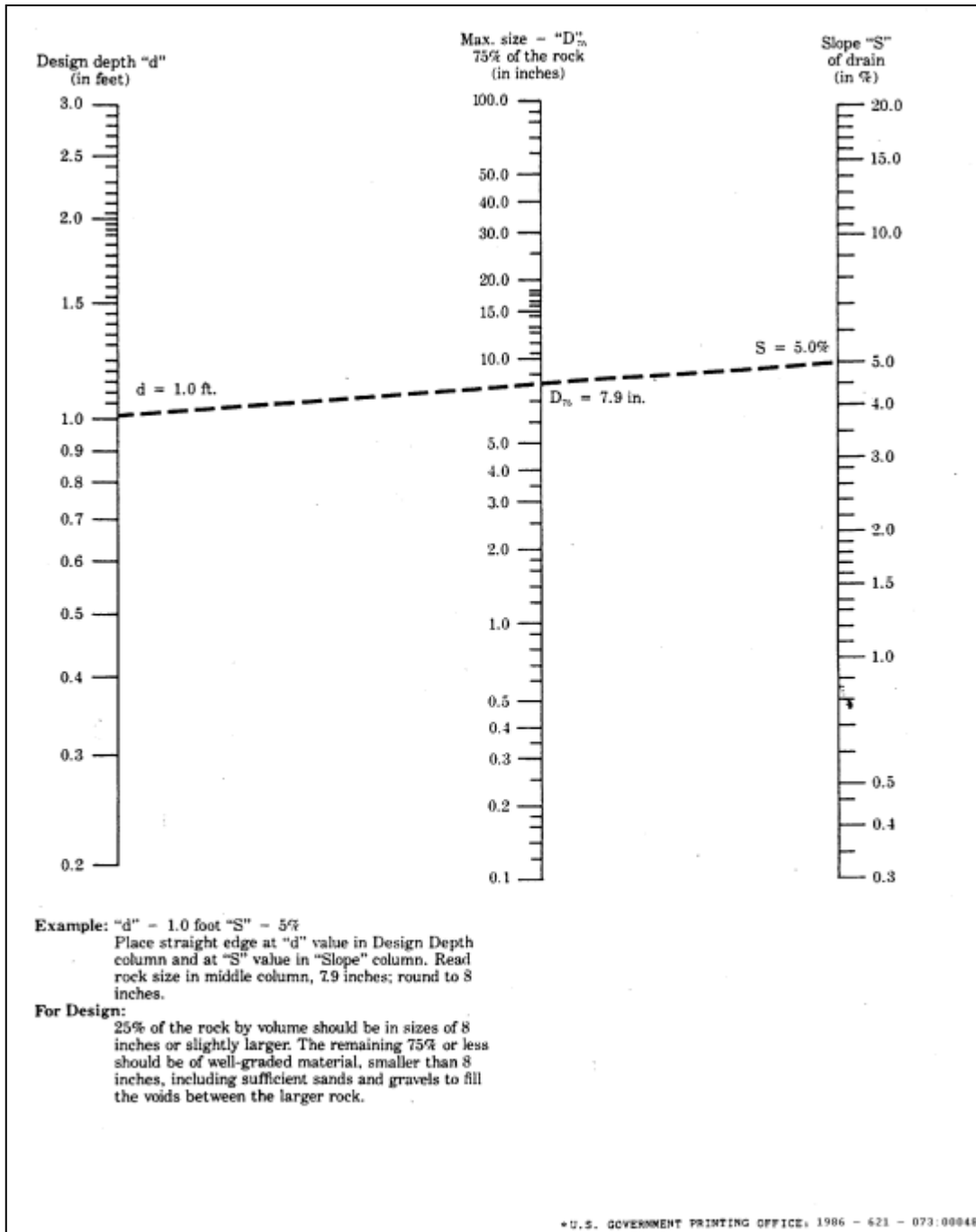

Outlet

The outlet must handle the design flow without flood damage. The outlet must be stable for the 10-year storm.

Vegetation - Permanent Cover

A permanent vegetative cover shall be established on all grassed waterways in accordance with the Standard for Permanent Vegetative Cover for Soil Stabilization or Standard for Permanent Stabilization with Sod. Where the season and other conditions may not be suitable for growing permanent erosion resistant cover, erosion protection will be provided in accordance with the Standard for Temporary Vegetative Cover for Soil Stabilization or by the use of a Class 2 Flexible Channel Liner as described above. The seeding will extend to at least the design top width.

Installation Requirements

Construction

Trees, brush, stumps and other material in objectionable amounts are to be cleared and disposed of so as not to interfere with construction or proper functioning of the waterway.

Fills are to be compacted as needed to prevent unequal settlement that will cause damage in the completed waterway. Where deep cuts are made into the subsoil, consideration shall be given to adding organic soil amendments or topsoil.

Vegetative Lining

Waterways or outlets shall be protected against erosion by vegetative means as soon after construction as practical and before diversions or other channels are discharged into them. Consideration should be given to the use of a flexible channel liner or sodding channels to provide erosion protection as soon after construction as possible.

Seeding, fertilizing, mulching and sodding shall be in accordance with the applicable Standards.

Maintenance

Routine maintenance of the vegetative lining, including mowing, liming and fertilizing must be performed to ensure that the waterway continues to perform as designed (see the Standard for Maintaining Vegetation). If maintenance cannot be or is not planned to be performed an alternate means of waterway stabilization or means of runoff conveyance should be considered.

STANDARD FOR LAND GRADING

Definition

Reshaping the ground surface by grading to planned elevations which are determined by topographic survey and layout.

Purpose

The practice is for one or more of the following: Provide more suitable sites for land development; improve surface drainage and control erosion.

Conditions Where Practice Applies

This practice is applicable where grading to planned elevations is practical and it is determined that grading is needed. Grading that involves the disturbance of vegetation over large areas shall be avoided. It may be necessary to provide for temporary stabilization of large areas.

Water Quality Enhancement

Proper grading of disturbed sites will protect against soil loss from erosion, enhance establishment of permanent vegetative cover and help to properly manage stormwater runoff all of which will reduce off site discharge of pollutants.

Planning Criteria

The grading plan and installation shall be based upon adequate topographic surveys and investigations. The plan is to show the location, slope, cut, fill and finish elevation of the surfaces to be graded. The plan should also include auxiliary practices for safe disposal of runoff water, slope stabilization, erosion control and drainage. Facilities such as waterways, ditches, diversions, grade stabilization structures, retaining walls and subsurface drains should be included where necessary.

Erosion control measures shall be designed and installed in accordance with the applicable standard contained herein.

The development and establishment of the plan shall include the following:

1. The cut face of earth excavations and fills shall be no steeper than the safe angle of repose for the materials encountered and flat enough for proper maintenance.
2. The permanently exposed faces of earth cuts and fills shall be vegetated or otherwise protected from erosion.
3. Provisions shall be made to safely conduct surface water to storm drains or suitable water courses and to prevent surface runoff from damaging cut faces and fill slopes.
4. Subsurface drainage is to be provided in areas having a high water table, to intercept seepage that would adversely affect slope stability, building foundations or create undesirable wetness. See Standard for Subsurface Drainage, pg. 32-1.
5. Adjoining property shall be protected from excavation and filling operations.
6. Fill shall not be placed adjacent to the bank of a stream or channel, unless provisions are made to protect the

hydraulic, biological, aesthetic and other environmental functions of the stream.

Soil Management and Preparation

Subgrade soils prior to the application of topsoil shall be free of excessive compaction to a depth of 6.0 inches to enhance the establishment of permanent vegetative cover.

This section of this Standard addresses the potential for excessive soil compaction in light of the intended land use, testing for excessive soil compaction where permanent vegetation is to be established and mitigation of excessive soil compaction when appropriate.

Due to use or setting, certain disturbed areas will not require compaction remediation including, but not limited to the following:

1. Within 20 feet of building foundations with basements, 12 feet from slab or crawl space construction.
2. Where soils or gravel surfaces will be required to support post-construction vehicular traffic loads such as roads, parking lots and driveways (including gravel surfaces), bicycle paths or pedestrian walkways (sidewalks etc)
3. Airports, railways or other transportation facilities
4. Areas requiring industry or government specified soil designs, including golf courses, landfills, wetland restoration, septic disposal fields, wet/lined ponds, etc.
5. Areas governed or regulated by other local, state or federal regulations which dictate soil conditions
6. Brownfields (capped uses), urban redevelopment areas, , in-fill areas, , recycling yards, junk yards, quarries and
7. Slopes determined to be inappropriate for safe operation of equipment
8. Portions of a site where no heavy equipment travel or other disturbance has taken place
9. Areas receiving temporary vegetative stabilization in accordance with the Standard.
10. Where the area available for remediation practices is 500 square feet or less in size.
11. Locations containing shallow (close to the surface) bedrock conditions.

Areas of the site which are subject to compaction testing and/or mitigation shall be graphically denoted on the certified soil erosion control plan.

Soil compaction remediation or testing to prove remediation is not necessary will be required in areas where permanent vegetation is to be established that are not otherwise exempted above. Testing method shall be selected, and soil compaction testing shall be performed by, the contractor or other project owner's representative (e.g. engineer). A minimum of two (2) tests shall be performed for projects with an overall limit of disturbance of up to one (1) acre and at a rate of two (2) tests per acre of the overall limit of disturbance for larger areas which shall be evenly distributed over the area of disturbance subject to testing. Tests shall be performed in areas representative of the construction activity prevailing in the area. In the event this testing indicates compaction in excess of the maximum thresholds indicated for the testing method, the contractor/owner shall have the option to perform compaction mitigation over the entire disturbed area (excluding exempt areas) or to perform additional testing to establish the limits of excessive compaction whereupon only the excessively compacted areas would require compaction mitigation.

Soil compaction testing is not required if/when subsoil compaction remediation (scarification/tillage (6" minimum depth) or similar) is proposed as part of the sequence of construction.

Soil Test Method Options

1. Probing Wire Test Method

This test shall be conducted with a firm wire (15-1/2 gauge steel wire - e.g. survey marker flag, straight wire stock, etc.), 18 to 21 inches in length, with 6" inches from one end visibly marked on the wire. Conduct wire flag test by holding the wire flag near the flag end and push it vertically into the soil at several different locations in the field to the lesser of a 6 inch depth or the depth at which it bends due to resistance in the soil. Record the depth at which it bends due to resistance in the soil. The wire should penetrate without bending or deforming at least 6" into the ground by hand, without the use of tools. If penetration fails and an obstruction is suspected (rocks, root, debris, etc.) the test can be repeated in the same general area. If the test is successful the soil is not excessively compacted. If the wire is difficult to insert (wire bends or deforms prior to reaching 6 inches in depth) the soil may be excessively compacted and compaction mitigation or further testing via method 3 or 4 below is required, the choice of which is at the contractor/owner's discretion.

2. Handheld Soil Penetrometer Test Method

This test shall be conducted based on the Standard Operation Procedure (SOP) #RCE2010-001, prepared by the Rutgers Cooperative Extension, Implemented June 1, 2010, last revised February 28, 2011. A result of less than or equal to 300 psi shall be considered passing. If the result is greater than 300 psi the soil may be excessively compacted and compaction mitigation or further testing via method 3 or 4 below is required, the choice of which is at the contractor/owner's discretion.

3. Tube Bulk Density Test Method

This test shall be certified by a New Jersey Licensed Professional Engineer utilizing only undisturbed samples (reconstitution of the sample not permitted) collected utilizing the procedure for Soil Bulk Density Tests as described in the USDA NRCS Soil Quality Test Kit Guide, Section 1-4, July 2001. When the texture of the soil to be tested is a sand or loamy sand and lack of soil cohesion or the presence of large amounts of coarse fragments, roots or worm channels prevent the taking of undisturbed samples, this test shall not be used.

Where the results of replicate tests differ by more than ten percent (10%), the samples shall be examined for the following defects:

- i. Cracks, worm channels, large root channels or poor soil tube contact within the samples;
- ii. Large pieces of gravel, roots or other foreign objects
- iii. Smearing or compaction of the upper or lower surface of the samples

If any of the defects described in 3 (i-iii) above are found, the defective core(s) shall be discarded and the test repeated using a new replicate sample for each defective replicate sample. The bulk density (defined as the weight of dry soil per volume) results shall be compared with the Maximum Dry Bulk Densities in Table 19-1. A result of less than or equal to the applicable maximum bulk density shall be considered passing. If the result is greater than the maximum bulk density the soil shall be considered excessively compacted and compaction mitigation is required.

4. Nuclear Density Test Method

This test shall be certified by a New Jersey Licensed Professional Engineer and conducted by a nuclear gauge certified inspector pursuant to ASTM D6938 . The bulk density measurement results shall be compared with the Maximum Dry Bulk Densities in Table 19-1. A result of less than or equal to the applicable maximum bulk density shall be considered passing. If the result is greater than the maximum bulk density the soil shall be considered excessively compacted and compaction mitigation is required.

Table 19-1 – Maximum Dry Bulk Densities (grams/cubic centimeter) by soil type

Soil Type/Texture	Bulk Density (g/cc)
Coarse, Medium and Fine Sands and Loamy Sands	1.80
Very Fine Sand and Loamy Very Fine Sand	1.77
Sandy Loam	1.75
Loam, Sandy Clay Loam	1.70
Clay Loam	1.65
Sandy Clay	1.60
Silt, Silt Loam	1.55
Silty Clay Loam	1.50
Silty Clay	1.45
Clay	1.40

Source: USDA Natural Resource Conservation Service, Soil Quality Information Sheet, Soil Quality Resource Concerns: Compaction, April 1996

5. Additional testing methods which conform to ASTM standards and specifications, and which produce a dry weight, soil bulk density measurement may be allowed subject to District approval.

Procedures for Soil Compaction Mitigation

If subgrade soils are determined to be excessively compacted by testing, as identified above, procedures shall be used to mitigate excessive soil compaction prior to placement of topsoil and establishment of permanent vegetative cover.

Restoration of compacted soils shall be through deep scarification/tillage (6" minimum depth) where there is no danger to underground utilities (cables, irrigation systems, etc.) or in the alternative, another method as specified by a New Jersey Licensed Professional Engineer.

Installation Requirements

Timber, logs, brush, rubbish, rocks, stumps and vegetative matter which will interfere with the grading operation or affect the planned stability or fill areas shall be removed and disposed of according to the plan.

Topsoil is to be stripped and stockpiled in amounts necessary to complete finish grading of all exposed areas requiring topsoil. See Standard for Topsoiling, pg. 8-1.

Fill material is to be free of brush, rubbish, timber, logs, vegetative matter and stumps in amounts that will be detrimental to constructing stable fills.

All structural fills shall be compacted as determined by structural engineering requirements for their intended purpose and as required to reduce slipping, erosion or excessive saturation.

All disturbed areas shall be left with a neat and finished appearance and shall be protected from erosion. See Standards for Permanent Vegetative Cover for Soil Stabilization, pg. 4-1.

Trees to be retained shall be protected if necessary in accordance with the Standard for Tree Protection During Construction, pg. 9-1.

**STANDARD
FOR
LINED WATERWAY**

Definition

A watercourse with an erosion resistant lining of concrete, stone or other permanent material. The lined section extends up the side slopes to design flow depth. The earth above the permanent lining shall be vegetated or otherwise protected.

Scope

This standard applies to waterways with linings of non-reinforced, cast-in place concrete; flagstone mortared in place; rock riprap or similar permanent linings. This standard does not apply to grassed waterways with stone centers. The maximum capacity of the lined waterway flowing at design flow depth shall not exceed 100 cfs.

Purpose

Waterways are lined to provide for safe disposal or runoff without damage by erosion or flooding in situations where grassed waterways would be inadequate.

Conditions Where Practice Applies

This practice applies where the following conditions exist:

1. The water velocity is such that lining is required to control erosion in the waterway.
2. Wetness, prolonged base flow or seepage would prohibit establishment of erosion-resistant vegetation.
3. The location is such that damage from use by people, vehicles or animals precludes use of vegetated waterways.
4. High value property or adjacent facilities warrant the extra cost to contain design runoff in a limited space.
5. Soils are highly erodible, highly acidic or other soil or climatic conditions precludes using vegetation.
6. On slopes greater than 10% the Standard for Slope Protection Structures shall apply.

Water Quality Enhancement

This standard is intended to protect larger capacity waterways from the extreme forces of erosion resulting from concentrated, high volume - high velocity flows. The primary benefit will be the prevention of soil loss from the channel lining surface. Subsequently, areas downstream will be protected from the deleterious effects of sediment deposition and conveyance of soil nutrients into local surface and groundwater systems.

Design CriteriaCapacity

Capacity shall be computed using Manning's formula or water surface profile models such as HEC RAS with a coefficient of roughness "n" as follows:

Table 20-1 Manning's "n" Values for Various Channel Lining Materials

LINING	"n" VALUE
Concrete Trowel finish	0.012 - 0.014
Float finish	0.013 - 0.017
Gunite	0.016 - 0.022
Cable or articulated block	Specified by manufacturer
Flagstone	0.020 - 0.025
Wire Mesh Stone filled baskets	0.025
Riprap	see the Standard for Riprap

Peak discharge values shall be determined by the following:

1. Rational Method - for peak discharge of uniform drainage areas as outlined in Technical Manual for Land Use Regulation Program, Bureau of Inland and Coastal Regulations Stream Encroachment Permits, Trenton, N.J. September 1997 or subsequent editions.
2. USDA-NRCS Win TR-55 or Win TR-20.
3. U.S. Army Corps of Engineers HEC HMS.
4. Other methods which produce similar results to the models listed above.

Minimum capacity and velocity shall be based on the 10 year frequency storm unless a larger storm event is to be conveyed for reasons of safety, compatibility with other stormwater management measures, etc.

Velocity

Maximum design velocity shall be as shown below. Except for short transition sections, slopes in the range of 0.9 to 1.10 of the critical slope must be avoided.

Table 20-2 Flow Depths and Velocities for Lined Waterway Design

DESIGN FLOW DEPTH	MAXIMUM VELOCITY
0.0 - 0.5'	25 FPS
0.5 - 1.0'	15 FPS
> 1.0'	10 FPS

Lined waterways with velocities exceeding critical shall discharge into an energy dissipater to reduce velocity to less than critical.

Cross-Section

The cross-section shall be triangular, parabolic or trapezoidal. Monolithic concrete may be rectangular.

Freeboard

The minimum freeboard for lined waterways shall be 0.25 feet above design flow depth in areas where erosion resistant vegetation cannot be grown adjacent to the lined side slopes. No freeboard is required where good vegetation can be grown and is maintained.

Side slope

Steepest permissible side slopes, horizontal to vertical will be as follows:

Table 20-3 Side Slopes for Corresponding Lining Materials

LINING	STEEPEST PERMISSIBLE SIDE SLOPE
Non-Reinforced Concrete- Hand-placed, formed concrete Height of lining 1.5 feet or less	vertical
Hand-placed, screeded concrete or mortared in-place flagstone- Height of lining less than 2 feet Height of lining more than 2 feet	1 to 1 2 to 1
Reinforced slip form concrete- Height of lining less than 3 feet	1 to 1
Rock riprap	2 to 1

Lining Thickness

Minimum lining thickness shall be as follows:

Concrete

Poured in place, reinforced - 4.0 inches

Interlocking concrete blocks - per manufacturer's instructions

Cabled concrete - per manufacturer's instructions (non-corroding cable shall be used)

Rock riprap - as per Standard for Riprap

Flagstone - 4 inches including mortar bed

Related Structures

Side inlets, drop structures and energy dissipaters shall meet the hydraulic and structural requirements for the site.

Filters or bedding

For non-reinforced concrete flagstone linings, installation shall be made only on low shrink-swell soils that are well drained or where subgrade drainage facilities are installed.

Filters or bedding to prevent piping, prevent erosion, reduce uplift pressure and collect water will be used and will be designed in accordance with "National Cooperative Highway Research Program Report 108 - Tentative Design Procedures for Riprap-Lined Channels," USDA-NRCS procedures or other generally accepted methods. Weep holes and drains will be provided as needed.

Concrete or Mortar

Concrete or mortar shall meet New Jersey Department of Transportation Standard Specifications, Ref. #10, Appendix A11.

Rock Riprap or Flagstone

Stone used for riprap or flagstone shall be dense and hard enough to withstand exposure to air, water, freezing and thawing. Flagstone shall be flat for ease of placement.

**STANDARD
FOR
OFF-SITE STABILITY**

Definition

A condition below and beyond the immediate limits of the site or property where the soil and related natural resources are subject to damage directly or indirectly by the discharge of stormwater runoff.

Purpose

To protect and maintain the stability and integrity of natural resources on downstream or off-site property due to changes in the rate and volume of stormwater runoff associated with construction activity and of land development.

Conditions Where Practices Applies

For purposes of analysis two areas of concern shall be addressed: (1) at the point of discharge and (2) downstream of the discharge point (which may require a watershed-based analysis).

Technical criteria for demonstrating off-site stability include consideration of proximity to a defined waterway, site topography (slope), soil texture, vegetative cover and other factors. Where the potential for erosive forces from stormwater runoff exceeds the threshold of acceptability as defined below, the plan shall provide for the construction of a stabilized channel, installation of a conduit to a stable condition or other types of hydraulic improvements to the channel. Additional design criteria or restrictions from the New Jersey Department of Environmental Protection or the New Jersey Pinelands Commission may also apply.

Water Quality Enhancement

Stormwater runoff is that portion of precipitation that returns to water bodies over the surface of the ground. The amount of stormwater runoff in a given area is a function of several factors including but not limited to: the amount and intensity of precipitation, soil texture, vegetative cover and slope. Unless properly managed stormwater runoff can adversely affect the environment through increased flood damages, increased erosion and sedimentation, increased waterway surges, destruction of vegetation, impaired water quality and increased turbidity. By addressing these factors in combination with one another this standard provides guidance for the design of off-site stormwater discharge which will result in minimized environmental impact and the long term protection of downstream water quality.

Design Criteria

This Standard involves two areas of analysis: (1) at the point(s) of stormsewer discharge and (2) beyond the site boundaries, typically a receiving channel or waterway. Stability documentation for each area is outlined in detail below. Generally the analyses involve the manipulation of peak rates of discharge for the 2 and 10 year, 24 hour storm events such that peak flow rate values and velocities are below established thresholds. Discharges shall be located in areas with low gradient topography and covered in perennial erosion resistant vegetation as noted in table 21-1 below.

Special consideration shall be given to the use of infiltration for peak flow modifications as follows:

Point of Discharge Stability Analysis

When infiltration practices are proposed, an alternate analysis (failure analysis) must be provided which ignores infiltration (no dead storage volume available, no static or dynamic infiltration loss rates in the routing calculations, etc) and demonstrates that no erosion will occur at the point of discharge if infiltration fails to function. Flow rates based solely upon basin inlet and outlet hydraulics must be used in comparison to Table 21-1 (below) to document a stable outlet.

Downstream (off-site) Stability Analysis.

Infiltration may be used to meet peak flow reduction requirements (outlined below) for the purposes of documenting stability of the downstream receiving channel, provided that the complete loss of infiltration function does not result in an increase in peak flow values above the predevelopment levels.

A generalized procedure for assessing point and offsite stability is depicted in figure 21-1:

**Figure 21-1
Point Discharge and Downstream Stability Analysis Procedure**

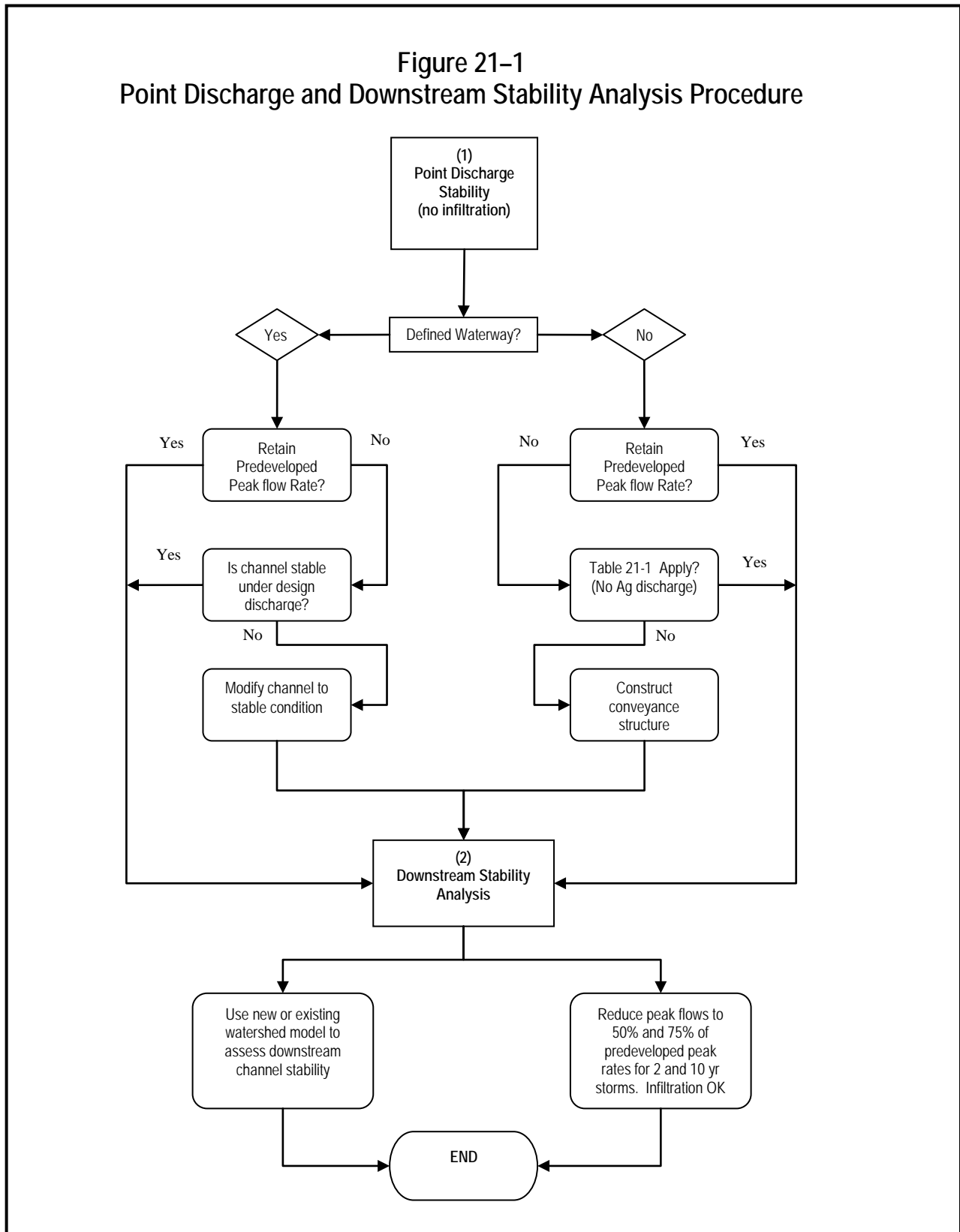

Point of Discharge - Methods for Achieving Stability**1. No well-defined waterway below the point of discharge:**

Stability cannot be achieved by the allowable velocity method since there can be no determination where the runoff will concentrate. A land-form not previously subjected to concentrated water flow will become unstable.

Stability can be achieved by one of the following alternatives:

- a. Retain pre-existing runoff characteristics. Do not increase the amount and rate of runoff for the development and **do not concentrate flows**.
- b. Where there is no well defined channel, no sandy condition, no trees or brush to substantially concentrate the flows and it can be reasonably assumed that the flow will disperse over a broad area. The combinations of slopes and soils in table 21-1 and the following criteria are considered stable for flows of 10cfs or less for a 25 year, 24hr design storm.

Table 21-1 Non-Erosive Velocities for Point Discharges

Maximum Stable Slope for Point Discharges for Various Soils	
Soil Type	Perennial, Natural Vegetation
	Maximum Slope (%)
Sands	1.8
Sandy loam	2.0
Silt loam, loam	2.5
Sandy clay loam	3.5
Clay loam	5.0
Graded loam to gravel	8.0

Stability Criteria (in conjunction with table 21-1)

- i. The maximum discharge rate shall be 10 cfs or less for the twenty-five (25) year storm.
- ii. Multiple outlets may be utilized to reduce individual outlet flow rates to levels below the thresholds noted above. Outlets should be spaced no closer than 50 ft horizontally to avoid re-mixing of flows
- iii. Flow over the outlet area shall be less than 0.5 cfs/ft. Designers shall not design excessive widths which will cause flows to concentrate.
- iv. Conduit outlet protection shall be provided in accordance with that Standard and may include: flat aprons, preformed scour holes, impact basins, stilling wells, plunge pools, etc. **Level spreaders are not an acceptable design.**
- v. Topography shows broad uniform outlet area where flows will not concentrate.

- vi. Discharge locations shall contain perennial, erosion resistant vegetation
 - vii. Peak discharge velocities (in the last pipe section) do not exceed 2 fps.
 - viii. The maximum length of slope below the outlet(s) is 100 feet
- c. Construct conveyance structure (pipe or channel)
- i. Pipe to a stable condition. When constructing a pipe through wetlands, an impervious trench shall be required. The pipe trench shall be compacted and filled with impervious material instead of the classic stone filled trench. The Conduit Outlet Protection Standard shall be adhered to.
 - ii. Construct a channel pursuant to the Standards for:
 - Channel Stabilization
 - Grassed Waterways
 - Lined Waterways
 - Rip Rap
 - Soil Bioengineering

Discharge to Agricultural Lands

Conditions represented in table 21-1 (and following) presume the presence of perennial, natural vegetation and in-situ, undisturbed soil conditions. Agricultural lands which are routinely disturbed due to cultivation and harvesting practices do not conform to the presumptions of this model and are therefore not suitable locations for point discharge. Generally, discharges to actively cultivated agricultural lands will require the construction of a conveyance structure across fields and land owner permission to discharge stormwater. Verification of landowner permission along with all appropriate engineering designs must be submitted to the soil conservation district to be considered for plan certification

Note: Some form of detention may be required in conjunction with the use of a constructed pipe or channel depending on the final discharge location. Consideration shall be given to the effects of an extended time of peak discharge duration as compared to the instantaneous peak discharge when detention is not used. Extended peak runoff may saturate the soil, destroy existing vegetation and loosen the soil to an eroding condition. If detention is required, the Standard for Detention Structures shall be addressed.

2. Well-defined waterway¹ below the point of discharge:

- a. Retain pre-developed runoff characteristics. Do not increase the rate of runoff from development.
- b. Analyze the waterway or channel for stability under the planned rate of discharge using the Standard for Grassed Waterways or Standard for Channel Stabilization, as appropriate. Peak flows from the 2 and 10 year storms shall be analyzed.

¹ "Waterway" shall be construed to mean an actual channel, gully or topographic landform which has a discernable cross section.

- c. Modify the waterway or channel to a stable design condition.

Downstream of the Point of Discharge (Off-Site Stability Analysis)

In addition to ensuring erosion does not occur at the point of discharge, areas downstream and beyond the immediate area of site development may be damaged due to erosive forces resulting from extended duration of hydrograph peak flows. An unintended consequence of the practice of detaining and slowly releasing stormwater is the ability for peak flows to be sustained for longer periods of time, offering an opportunity for upstream discharges to coincide with project site discharges. The resulting combined discharge may be equal to or even exceed that of the pre-development condition.

To limit the potential for such an occurrence the designer may choose either of two approaches for **downstream stability** protection:

1. Examine hydraulic characteristics of the receiving stream channel considering upstream discharge in combination with site discharge to assess channel stability. The scope and scale of the analysis shall be appropriate to the scale of the project and the post development peak discharge rate and volume. Of particular concern are hydraulic control points, (culverts , bridges, etc.), bends in streams and sudden changes in channel cross sections downstream of the discharge point. The following may be utilized to assess stability:
 - a. Utilize an existing watershed or regional stormwater management plan to verify the proposed discharge will not cause erosion downstream of the discharge point. The model should reflect the current conditions in the watershed.
 - b. Perform a new watershed analysis. Modeling multiple watersheds, routing stormwater structures and modeling water surface profiles shall be done, as necessary, to determine pre and post development velocities in channels and through structures.

Analysis of the receiving channel shall include a comparison of pre and post condition velocities in the channel and overbank (if applicable) areas for the 2 and 10 year storm events. Cross sections and a scaled map of the section stations shall be included in the hydraulic analysis of the channel.

In the event the analysis determines that the post development runoff must be controlled prior to discharge, some form of detention will be required. Refer to the Standard for Detention Structures for design requirements.

2. In lieu of performing a comprehensive watershed analysis, design a detention facility that reduces peak flows to the following levels. Infiltration may be used to meet these criteria:

- 2 year storm – 50% of the predevelopment peak
- 10 year storm – 75% of the predevelopment peak

Reductions in peak flows are to be compared to **predeveloped** drainage area points of discharge in the event that drainage is re-directed in the post developed condition. **Reductions are only required of the developed or modified portions of the project site.**

Plan Requirements for Documenting Stability

In addition to a complete hydraulic and hydrologic analysis described above, drawings must be submitted with the erosion control plan which show the predeveloped drainage condition for the proposed point of discharge along with the time of concentration flow path.

STANDARD FOR RIPRAP

Definition

A layer of loose rock, aggregate, bagged concrete, gabions, or concrete revetment blocks placed over an erodible soil surface.

Purpose

The purpose of riprap is to protect the soil surface from the erosive forces of water.

Conditions Where Practice Applies

This practice applies to soil-water interfaces where the soil conditions, water turbulence and velocity, expected vegetative cover, and groundwater conditions are such that the soil may erode under the design flow conditions. Riprap may be used, as appropriate, at such places as channel banks and/or bottoms, roadside ditches, drop structures and shorelines of open freshwater bodies. Riprap may also be used in conjunction with Soil Bioengineering Techniques which are found in that standard (pg. 26-1). This Standard applies to slopes less than ten percent.

Water Quality Enhancement

Both stream channel and shoreline environments will benefit from the protection against erosion caused by flowing water and wave action. Protection of banks and shores not only prevents soil loss directly into surface waters, but also protects vegetation in these areas which contribute other water quality and wildlife benefits. .

Design Criteria - Open Channel Flow Conditions

Design Storm

The riprap shall be designed to be stable when the channel is flowing at the design discharge or the 25-year frequency storm discharge, whichever is greater.

Capacity shall be determined by the following methods:

1. Rational Method - for peak discharge of uniform drainage areas as outlined in Technical Manual for Land Use Regulation Program, Bureau of Inland and Coastal Regulations Stream Encroachment Permits, Trenton, N.J. September 1997 or subsequent editions
2. USDA-NRCS hydrologic procedures such as WinTR55 or WinTR20.
3. U.S. Army Corps of Engineers HEC HMS
4. Other methods which produce similar results to the models listed above.

Riprap Design

Storm water conveyance or flood control channels

Riprap shall be sized using the design procedures in this Standard or the "National Cooperative Highway Research Program Report No. 108, Tentative Design Procedure for Riprap-Lined Channels." These procedures are for

determining a design stone size, such that the stone is stable under the design flow conditions. The design stone size is the d_{50} stone diameter.

Erosive forces of flowing water are greater in bends than in straight channels. If the riprap size (d_{50}) computed for bends is less than 10% greater than the riprap size (d_{50}) for straight channels, then the riprap size for straight channels shall be considered adequate for bends. Otherwise, the larger riprap size shall be used in the bend. The riprap size to be used in a bend shall extend upstream from the point of curvature and downstream from the point of tangency a distance equal to five times the channel bottom width, and shall extend across the bottom and up both sides of the channel.

Riprap for banks shall extend up the banks to the level of the design storm or the top of bank, whichever is lower.

In channels where no riprap or paving is required in the bottom, but is required on the banks, the toe of the bank riprap shall extend below the channel bottom a distance at least 8 times the maximum stone size, but in no case more than 3 feet unless analysis of scour potential demonstrates the need for deeper installation. The only exemption to this would be if there is a non-erodible hard, rock bottom.

Stream stabilization- Soil Bioengineering

For determining d_{50} , riprap may be sized using the procedures in this Standard or procedures contained in Chapter 16 of the NRCS Engineering Field Handbook including the Isbash Curve or Lane's Method. For stream stabilization, the use of riprap is generally limited to critically erosive locations such as the base of the channel side slopes up to the elevation of the one year flow event. Riprap is designed to be used in combination with vegetation as a part of a bioengineering solution (see Standard for Soil Bioengineering). Riprap may be placed on slopes steeper than 2 horizontal to 1 vertical following the procedures in this Standard (Curve 22-6). Large, over-sized stone having a minimum d_{50} of 18 inches, or two times the required d_{50} , whichever is greater, may be stacked to a slope no steeper than 0.5 horizontal to 1 vertical where site conditions are acceptable. Stability of the stream bank and bed material along with the flow conditions in the stream shall be evaluated in determining site acceptability.

Riprap Gradation

The riprap shall be composed of a well-graded mixture such that 50% of the mixture by weight shall be larger than the d_{50} size as determined from the design procedure. A well-graded mixture as used herein is defined as a mixture composed primarily of the larger stone sizes, but with a sufficient mixture of other sizes to fill the progressively-smaller voids between the stones. The diameter of the largest stone size in such a mixture shall be 1.5 times the d_{50} size. The d_{75} should be 1.25 times the d_{50} and the d_{15} should be 0.5 times the d_{50} size.

The designer, after determining the riprap size that will be stable under the flow condition, shall consider that size to be a minimum size and then, based on riprap gradations actually available in the area, select the size or sizes that equal or exceed the minimum size. The possibility of vandalism shall be considered by the designer in selecting a riprap size.

Thickness of Riprap Lining

Construction techniques, discharge, size of channel, sizes and gradation of riprap, etc., should be taken into consideration when determining the thickness of riprap lining. The thickness of riprap lining shall meet at least one of the following two criteria:

1. A thickness of at least three times the d_{50} size if a filter layer is not used.
2. A thickness of at least two times the d_{50} size if a filter layer is used.

The minimum thickness shall be 6 inches.

Filter

Leaching is the process by which the finer base materials beneath the riprap are picked up and carried away by the turbulence that penetrates the interstices of the riprap. Leaching is reduced to a negligible rate by using a properly designed filter under the riprap, or by making the riprap layer thick enough and with fine enough interstices to keep erosion currents away from underlying soil.

A filter is required unless the riprap lining has a thickness of at least 3 times the d_{50} size of the riprap. On steep slopes, highly erodible soils, loose sand, or with high water velocities, a filter should be used or riprap thickness increased beyond the minimums.

A filter can be of two general forms. One is a geotextile manufactured for that express purpose. Another is a properly graded layer of sand, gravel, or stone.

A sand, gravel, or stone filter shall meet the following criteria:

$$\frac{d_{15} \text{ Riprap}}{d_{85} \text{ Filter}} < 5 < \frac{d_{15} \text{ Riprap}}{d_{15} \text{ Filter}} < 40$$

$$\frac{d_{50} \text{ Riprap}}{d_{50} \text{ Filter}} < 40$$

Where d_{15} , d_{50} , and d_{85} are the diameters of riprap and filter material of which 15, 50, and 85% are finer by weight. The base material may be used as the filter if it meets the above criteria. The minimum sand gravel or stone filter thickness shall be 6 inches or 3 times the d_{50} size of the filter, whichever is greater.

Geotextile fabric¹ shall meet the following criteria:

- A. For filter fabric adjacent to granular materials containing 50% or less by weight of fines (Minus No. 200 material):

For Woven Fabric:

1. $\frac{85\% \text{ size of material (mm)}}{\text{AOS}^2 \text{ (mm)}} \geq 1$

and AOS no smaller than the opening in the U.S. Standard Sieve No. 100

2. For non-woven fabric: AOS no larger than the opening in the U.S. Standard Sieve No. 40.

¹ Geotextile fabric shall meet the U.S. Army Corps of Engineers Guide Specifications, CW02215-86, for strength. Riprap that is 12" and larger shall not be dumped directly onto synthetic filter cloth unless the manufacturer recommends such use for the cloth. Otherwise, a 4-inch minimum thickness blanket of gravel shall be placed over the filter cloth. Where seepage forces exist or where hydrostatic pressures may be developed in the base soil, the permeability of the geotextile shall be 10 times the permeability of the base soil.

² Apparent Opening Size is defined as the number of the U.S. Standard sieve having openings closest in size to the geotextile openings.

B. For geotextile fabric adjacent to all other soils:

For woven fabric:

1. AOS no larger than the opening in the U.S. Standard Sieve No. 70, and AOS no smaller than the opening in the U.S. Standard Sieve No. 100.
2. For non-woven fabric: AOS no larger than the opening in the U.S. Standard Sieve No. 40.

Quality

Stone for riprap shall consist of field stone or quarry stone of approximately rectangular shape. The stone shall be hard and angular and of such quality that it will not disintegrate on exposure to water or weathering. The specific gravity of the individual stones shall be at least 2.5.

Rubble concrete may be used provided it has a density of at least 150 pounds per cubic foot, and otherwise meets the requirements of this Standard.

Bagged Concrete

Bagged concrete is made up of bags filled with concrete and placed next to each other. The consistency of the concrete shall be as stiff as satisfactory discharge from the mixer and the process of bagging will permit. The bags shall be filled three-quarters full with concrete and shall be laid in close contact, with staggered joints and tied ends turned in.

Bagged concrete may be used when all the following conditions are met:

1. The design storm, riprap size and location, and filter criteria for riprap are met.
2. The weight of the filled bags is at least equal to the weight of the maximum stone size required for rock riprap.
3. Settlement or lateral movement of foundation soils is not anticipated.
4. Ice conditions are not severe.
5. A filter is used.
6. Slopes somewhat steeper than 2 to 1 may be permitted under special circumstances.

Wire-mesh stone filled structures

Baskets formed of plastic-coated wire mesh and filled with cobbles or coarse gravel (a thinner version of gabions is known as a "mattress") may be used when all the following conditions are met:

1. The design storm shall be the same as that required for riprap. Riprap size and location, filter, and quality criteria shall be as outlined below.
2. The design water velocity does not exceed that given in table 22-1:

Table 22-1 Gabion Dimensions

GABION THICKNESS (ft.)	MAXIMUM VELOCITY (ft./sec.)
1/2	6
3/4	11
1	14

3. The Manning's "n" value used for gabions shall be 0.025.
4. The wire mesh structures are not exposed to abrasion from sand or gravel transported by moving water.
5. Plastic coated wire shall be used.
6. All wire mesh structures placed against the bottom of a channel shall be underlain by geotextile or a gravel filter designed according to the limits outlined in Table 22-1.
7. The rock used to fill basket structures shall be 4" to 7" angular, block-shaped rock. For wire mesh "mattress" structures, 3" to 4" stone may be used provided the mesh opening is small enough to contain the stone. Smaller stone will provide more stone "layers" in the mattress where larger stone would not sufficiently fill the structure's void space

Table 22-2 Maximum Gabion Slope by Soil Texture

Soil Texture	Erosive Velocity, VE (fps)	Maximum Allowable Bottom Slope (ft./ft.) using geotextile Fabrics*
Sandy Loam	2.5	0.029
Silt Loam	3.0	0.041
Sandy Clay Loam	3.5	0.056
Clay Loam	4.0	0.074
Clay, fine gravel, graded loam to gravel	5.0	0.115
Cobbles	5.5	0.139

*For bottom slopes steeper than those shown, a properly designed gravel filter shall be placed under the gabions.

Sand, gravel, or stone filters placed under wire mesh basket structures shall meet the filter requirements shown on page 22-3.

Concrete Revetment Blocks

Concrete revetment blocks are precast interlocking or cabled concrete grids designed for soil stabilization.

Concrete revetment blocks may be used when all the following conditions are met:

1. The design storm shall be the same as that required for riprap.

2. The water velocity does not exceed 9 feet per second.
3. The Manning's "n" value used for concrete revetment blocks shall be 0.026, unless otherwise recommended by manufacturer's literature.
4. A filter is used in accordance with manufacturer's recommendations.
5. Cabled-concrete shall use non-degrading, non-corroding cable.

Recommended Design Procedure for Riprap-Lined Channels

This design of riprap-lined channels is from the "National Cooperative Highway Research Program Report No. 108, Tentative Design Procedure for Riprap-Lined Channels." It is based on the tractive stress method, and covers the design of riprap in two basic channel shapes: trapezoidal and triangular.

NOTE: This procedure is for uniform flow at normal depth in channels and is not to be used for design of riprap energy dissipation devices immediately downstream from such high velocity devices as pipes and culverts. See the Standard for Conduit Outlet Protection, p. 12-1.

The method in Report No. 108 (design procedure beginning on p. 18) gives a simple and direct solution to the design of trapezoidal channels, including channel carrying capacity, channel geometry, and the riprap lining.

This procedure is based on the assumption that the channel is already designed and the remaining problem is to determine the riprap size that would be stable in the channel. The designer would first determine the channel dimensions by the use of Manning's equation. The "n" value for use in Manning's equation is obtained by estimating a riprap size and then determining the corresponding "n" value for the rip rapped channel from:

$$n = 0.0395(d_{50})^{0.167}$$

where d_{50} is in feet, or by using Curve 22-1 where d_{50} is in inches.

Curve 22-1

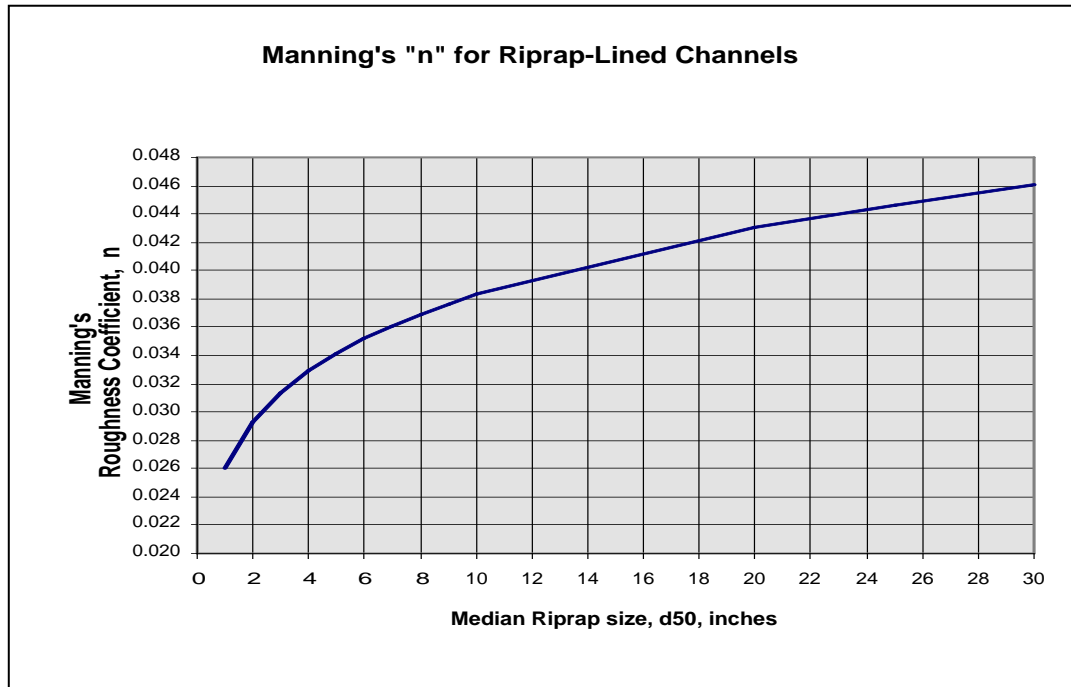

When the channel dimensions are known, the riprap can be designed (or an already completed design may be checked) as follows:

Trapezoidal Channels

1. Calculate the b/d ratio and enter Curve 22-2 to find the P/R ratio.
2. Enter Curve 22-3A with S_b , Q, and P/R to find median riprap diameter, d_{50} , for straight channels.
3. Enter Curve 22-1 to find the actual "n" value corresponding to the d_{50} from step 2. If the estimated and actual "n" values do not reasonably agree, another trial must be made.
4. For channels with bends, calculate the ratio B_s/R_o , where B_s is the channel surface width and R_o is the radius of the bend. Enter Curve 22-4 and find the bend factor, F_B . Multiply the d_{50} for straight channels by the bend factor to determine riprap size to be used in bends. If the d_{50} for the bend is less than 1.1 times the d_{50} for the straight channel, then the size for straight channel may be used in the bend; otherwise, the larger stone size calculated for the bend shall be used. The riprap shall extend across the full channel section and shall extend upstream and downstream from the ends of the curve a distance equal to five times the bottom width.
5. Enter Curve 22-5 to determine maximum stable side slope of riprap surface. In Curve 22-5, the side slope is established so that the riprap on the side slope is as stable as that on the bottom. If for any reason it is

desirable to make the side slopes steeper than what is given by Curve 22-5, the size of the riprap can be increased and the side slopes made steeper by using the following procedures:

- a. Compute d_{50} and maximum stable side slope as above.
- b. Enter Curve 22-6 with the computed side slope to determine K for that side slope.
- c. Enter Curve 22-6 with the desired side slope to determine K'.
- d. Compute riprap size for desired slope by the formula:

$$d_{50}' = d_{50} K/K'$$

6. Maximum side slopes, 2:1.

Triangular Channels

1. Enter Curve 22-3B with S_b , Q, and Z and find the median riprap diameter, d_{50} , for straight channels.
2. Enter Curve 22-1 to find the actual "n" value. If the estimated and actual "n" values are not in reasonable agreement, another trial must be made.
3. For channels with bends, see step 4 under Trapezoidal channels.

Example:

Given:

Trapezoidal channel

Q = 100 cfs.

S = 0.01 ft./ft.

Side slopes = 2.5:1.

Mean bend radius, $R_o = 25'$.

n = 0.033 (estimated, and used to design the channel to find that b = 6' and d = 1.8').

Type of rock available is crushed stone.

Solution:

Straight channel reach

$$b/d = 6/1.8 = 3.33.$$

from Curve 22-2, $P/R = 13.0$.

from Curve 22-3A, $d_{50} = 3.4"$

from Curve 22-1, n (actual) = 0.032, which is reasonably close to the estimated n of 0.033

Use 5" as maximum riprap size and 8" as riprap layer thickness with a filter.

Channel bend

$$B_s = b + 2zd = 6 + (2)(2.5)(1.8) = 15'$$

$$B_s/R_o = 15/25 = 0.60.$$

from Curve 22-4, $F_B = 1.33$

$F_B = 1.33 > 1.1$, therefore, the bend factor must be used.

$$\text{Riprap size in bend, } d_{50} = 3.4 \times 1.33 = 4.52"$$

The heavier riprap for the bend shall extend upstream and downstream from the ends of the bend a distance of $(5)(6) = 30$ feet.

From Curve 22-5, it can be found that the riprap for $d_{50} = 3.4"$ and $4.52"$ will both be stable on a 2.5:1 side slope.

Curve 22-2

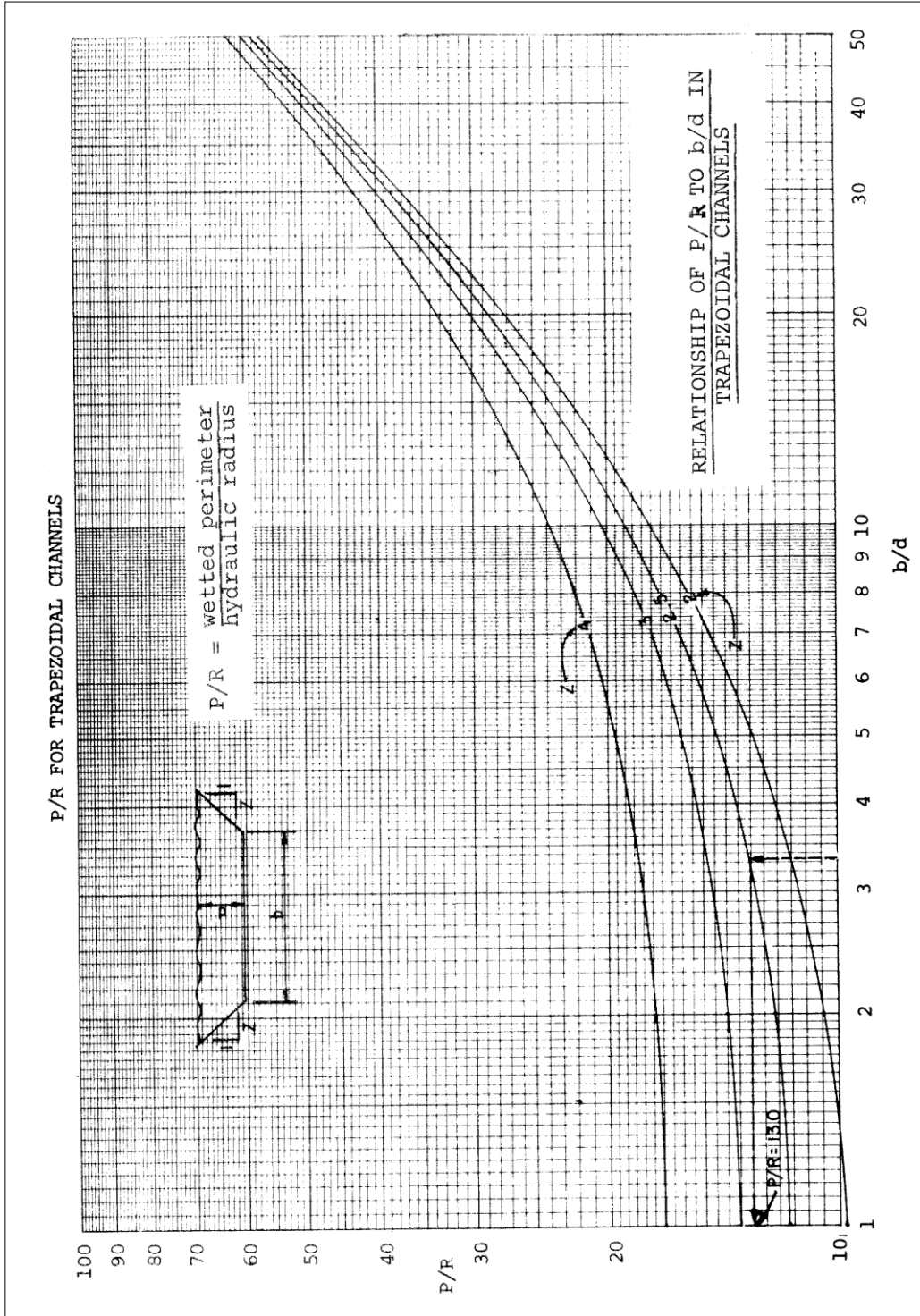

Curve 22-3A

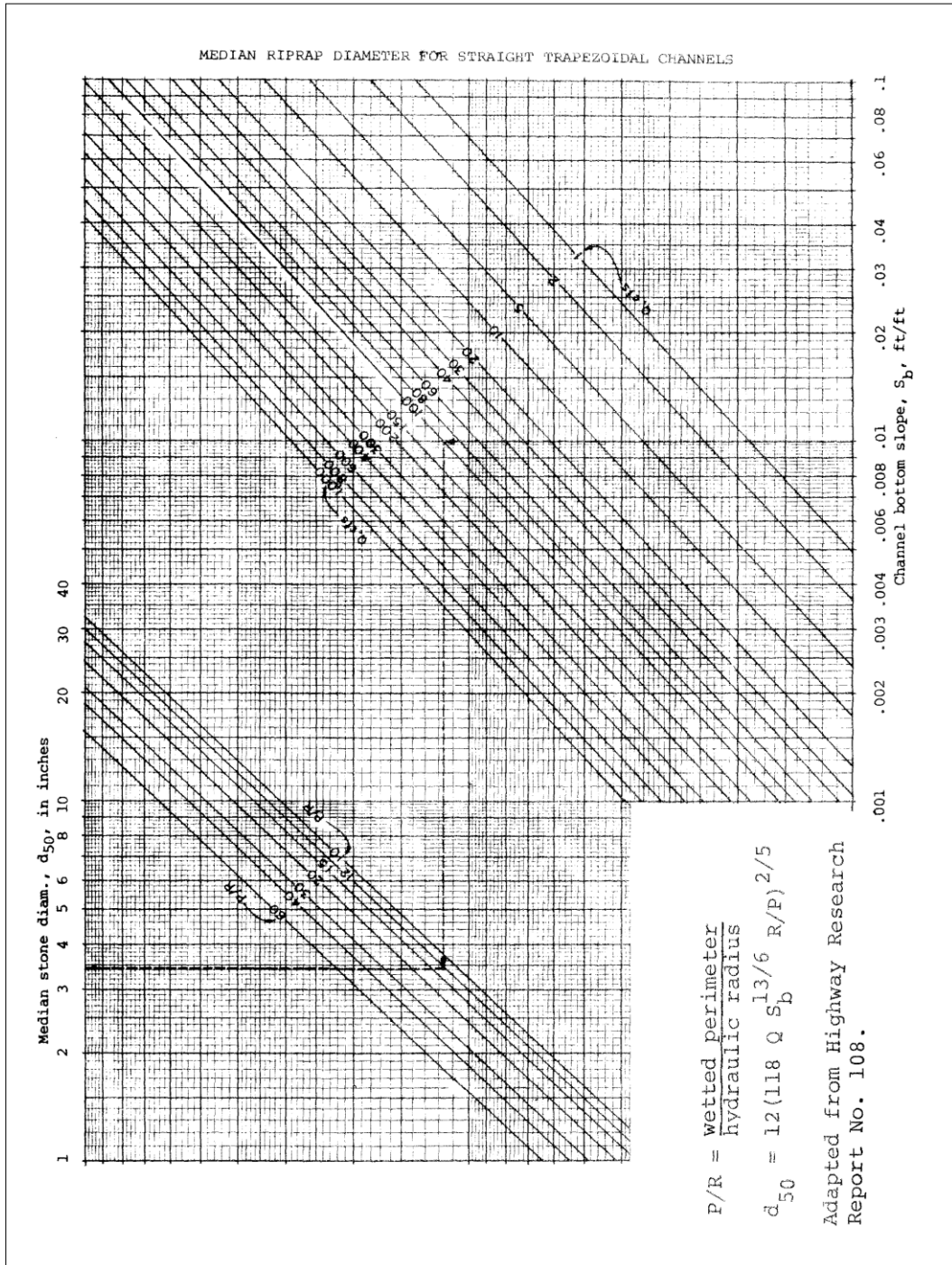

Curve 22-3B

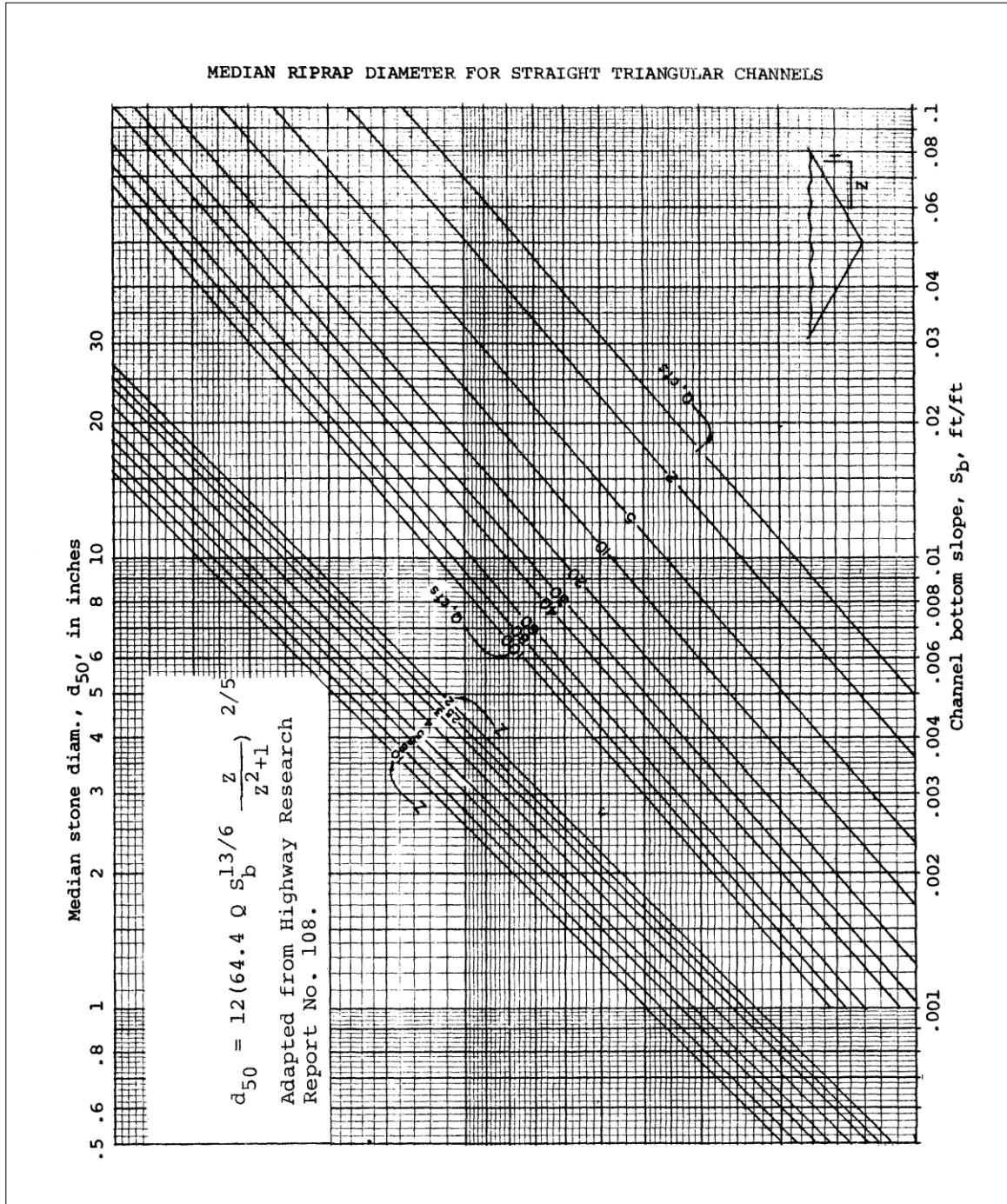

Curve 22-4

RIPRAP SIZE CORRECTION FACTOR FOR FLOW IN CHANNEL BENDS

d_{50} (for bend) = d_{50} (for straight) X F_B
 B_S = channel surface width
 R_O = mean radius of bend

Adapted from Highway Research Report No. 108.

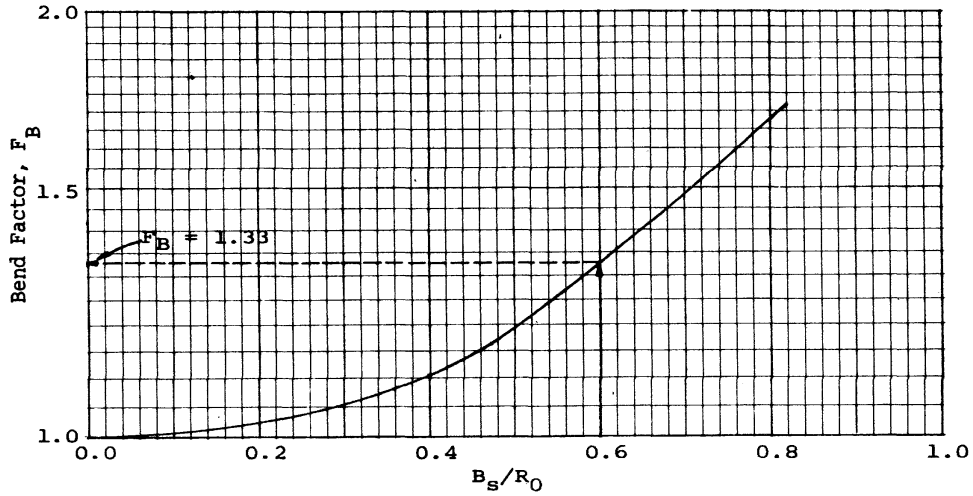

Curve 22-5

MAXIMUM RIPRAP SIDE SLOPE WITH RESPECT TO RIPRAP SIZE

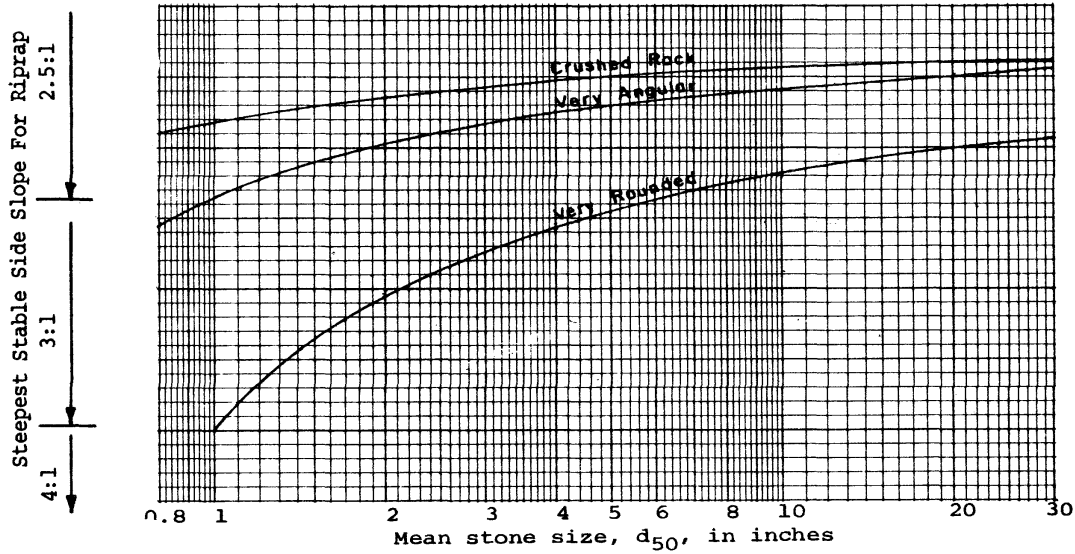

Curve 22-6

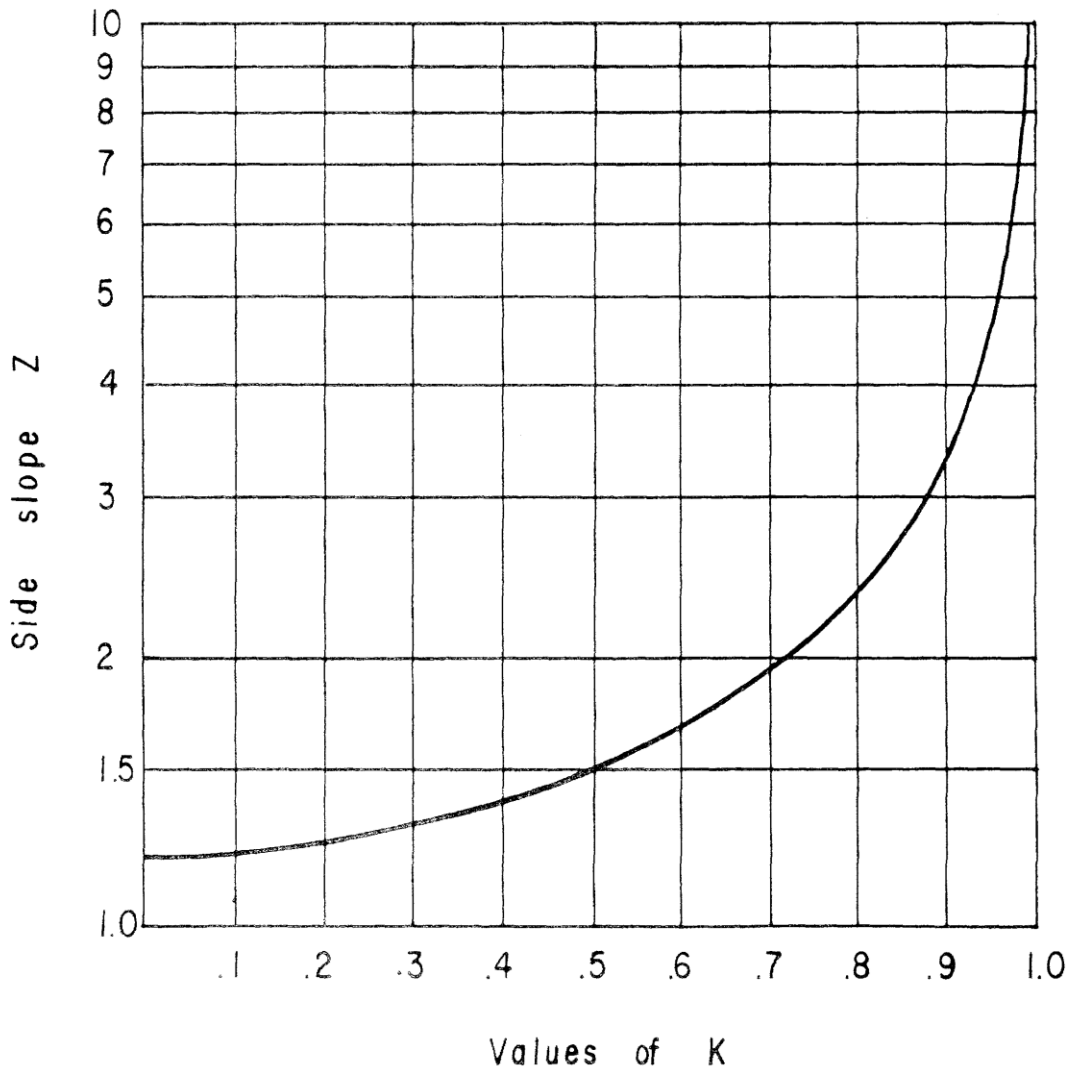

Riprap Shoreline Protection

Conditions where practice applies

This design procedure applies to riprap protection of shorelines surrounding open bodies of water, such as lakes, bays, estuaries etc. against the erosive action of surface waves. It is not intended as a design procedure for the protection of embankments of open channels. Refer to the beginning of this standard for open channel riprap design.

Design Procedure

1. Find wind speed from Figures 22-1 or 22-2 (figures are based on the 10 or 25 year return period). In general, use a 25 year return period unless a higher risk of failure is acceptable.
2. Find wave height from Table 22-3, 22-4, 22-5 or 22-6. Fetch length is the distance across open water in the prevailing wind direction.
3. Find rock weight (in lbs) from Tables 22-7, 22-8 and 22-9.
4. Find rock size (d_{50}) from Curve 22-7 Note: curve is calibrated for rock with a specific gravity of 2.6, or a unit weight of 165 lbs/ ft³. Table 22-9, Correction for unit weight, will correct for rock with a different unit weight.

Riprap is to be installed according to limits established for depth, filter material and slope as outlined earlier in this standard.

Example:

Given:

25 year storm event, fetch length of 1 mile, depth of 5 feet, installation slope of 1:3, and stone unit weight = 160 lbs/ft³, find:

1. From figure 22-2, wind speed for Central New Jersey for the 25 year design storm is 75 mph.
2. From Table 22-3, wave height is 2.0 feet for a fetch length of 1.0 mile and average depth of 5.0 feet.

3. From Table 22-7, the estimated required weight of stone based on wave height is 50 lbs. (per piece).
4. From Table 22-8, the correction factor for a slope of 1:3 is 0.7.
5. From Table 22-9, the correction factor for stone unit weight of 160 lbs/ft³ is 1.1.
6. The required stone weight is: $50 \times 0.7 \times 1.1 = 38.5$ lbs. (per piece).
7. From Curve 22-7, the d_{50} stone size for 38.5 lbs is 9.3 inches, say 9 inches.

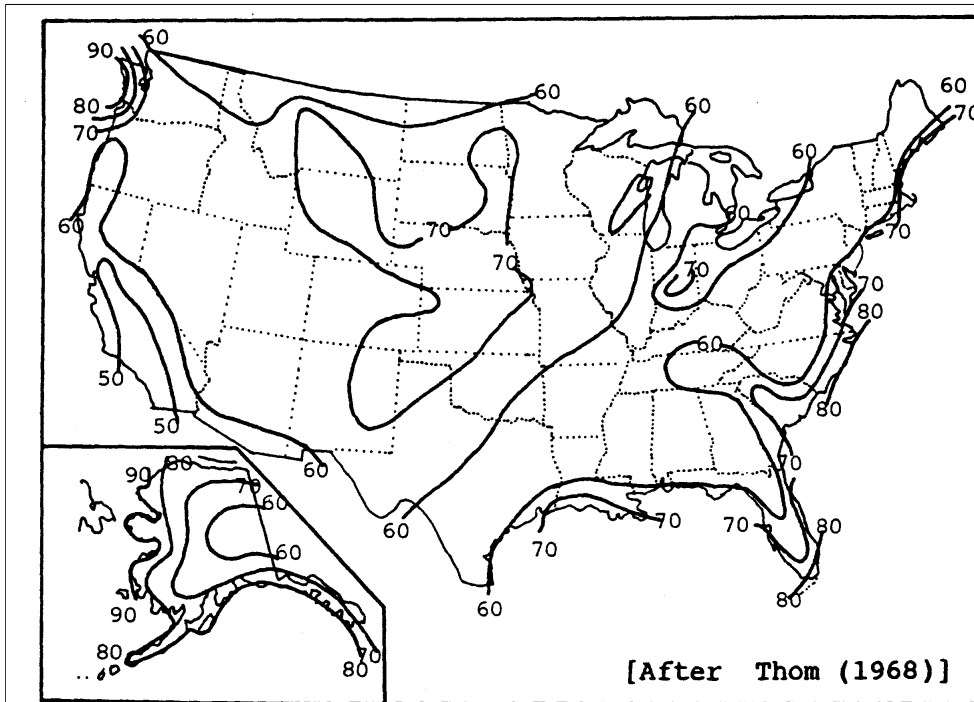

Figure 22-1 Fastest-Mile Wind Speeds: 10-year Return Period

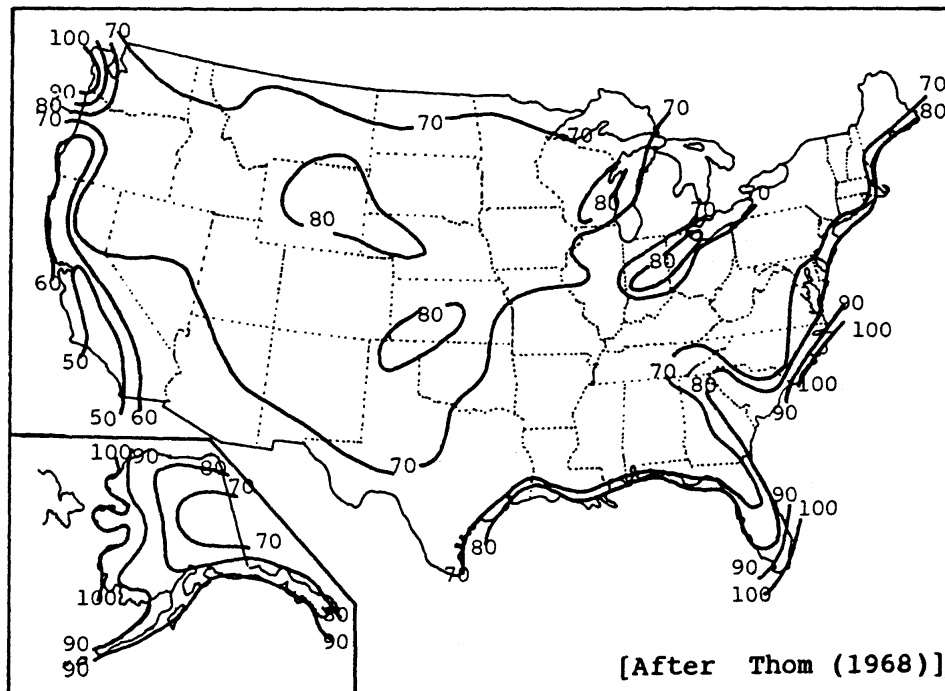

Figure 22-2 Fastest-Mile Wind Speeds: 25-year Return Period

Table 22-3
WIND-GENERATED WAVE HEIGHTS AND (PERIODS)
FETCH LENGTHS WITH AVERAGE DEPTHS = 5 FEET

Wind Speed (mph)	Fetch Length (miles)														
	0.5	1.0	1.5	2.0	2.5	3.0	3.5	4.0	4.5	5.0	6.0	7.0	8.0	9.0	10.0
10	0.5 (1.0)	0.5 (1.0)	0.5 (1.0)	0.5 (2.0)	0.5 (2.0)	0.5 (2.0)	0.5 (2.0)	0.5 (2.0)	0.5 (2.0)	0.5 (2.0)	0.5 (2.0)	0.5 (2.0)	0.5 (2.0)	0.5 (2.0)	0.5 (2.0)
20	0.5 (1.0)	0.5 (2.0)	1.0 (2.0)	1.0 (2.0)	1.0 (2.0)	1.0 (2.0)	1.0 (2.0)	1.0 (2.0)	1.0 (2.0)	1.0 (2.0)	1.0 (2.0)	1.0 (2.0)	1.0 (2.0)	1.0 (2.0)	1.0 (2.0)
30	1.0 (2.0)	1.0 (2.0)	1.0 (2.0)	1.0 (2.0)	1.5 (2.0)	1.5 (3.0)	1.5 (3.0)	1.5 (3.0)	1.5 (3.0)	1.5 (3.0)	1.5 (3.0)	1.5 (3.0)	1.5 (3.0)	1.5 (3.0)	1.5 (3.0)
40	1.0 (2.0)	1.5 (2.0)	1.5 (3.0)	1.5 (3.0)	1.5 (3.0)	1.5 (3.0)	1.5 (3.0)	1.5 (3.0)	1.5 (3.0)	1.5 (3.0)	1.5 (3.0)	1.5 (3.0)	1.5 (3.0)	1.5 (3.0)	1.5 (3.0)
50	1.5 (2.0)	1.5 (3.0)	1.5 (3.0)	1.5 (3.0)	1.5 (3.0)	2.0 (3.0)	2.0 (3.0)	2.0 (3.0)	2.0 (3.0)	2.0 (3.0)	2.0 (3.0)	2.0 (3.0)	2.0 (3.0)	2.0 (3.0)	2.0 (3.0)
55	1.5 (2.0)	1.5 (3.0)	2.0 (3.0)	2.0 (3.0)	2.0 (3.0)	2.0 (3.0)	2.0 (3.0)	2.0 (3.0)	2.0 (3.0)	2.0 (3.0)	2.0 (3.0)	2.0 (3.0)	2.0 (3.0)	2.0 (3.0)	2.0 (3.0)
60	1.5 (2.0)	2.0 (3.0)	2.0 (3.0)	2.0 (3.0)	2.0 (3.0)	2.0 (3.0)	2.0 (3.0)	2.0 (3.0)	2.0 (3.0)	2.0 (3.0)	2.0 (3.0)	2.0 (4.0)	2.0 (4.0)	2.0 (4.0)	2.0 (4.0)
65	1.5 (3.0)	2.0 (3.0)	2.0 (3.0)	2.0 (3.0)	2.0 (3.0)	2.0 (3.0)	2.0 (3.0)	2.0 (3.0)	2.0 (3.0)	2.0 (4.0)	2.0 (4.0)	2.0 (4.0)	2.0 (4.0)	2.0 (4.0)	2.0 (4.0)
70	2.0 (3.0)	2.0 (3.0)	2.0 (3.0)	2.0 (3.0)	2.0 (3.0)	2.0 (3.0)	2.0 (3.0)	2.0 (4.0)	2.0 (4.0)	2.0 (4.0)	2.0 (4.0)	2.0 (4.0)	2.0 (4.0)	2.0 (4.0)	2.0 (4.0)
75	2.0 (3.0)	2.0 (3.0)	2.0 (3.0)	2.0 (3.0)	2.0 (3.0)	2.0 (3.0)	2.0 (4.0)	2.0 (4.0)	2.0 (4.0)	2.0 (4.0)	2.0 (4.0)	2.0 (4.0)	2.0 (4.0)	2.0 (4.0)	2.0 (4.0)
80	2.0 (3.0)	2.0 (3.0)	2.0 (3.0)	2.5 (3.0)	2.5 (3.0)	2.5 (4.0)	2.5 (4.0)	2.5 (4.0)	2.5 (4.0)	2.5 (4.0)	2.5 (4.0)	2.5 (4.0)	2.5 (4.0)	2.5 (4.0)	2.5 (4.0)

Table 22-4
WIND-GENERATED WAVE HEIGHTS AND (PERIODS)
FETCH LENGTHS WITH AVERAGE DEPTHS = 10 FEET

Wind Speed (mph)	Fetch Length (miles)														
	0.5	1.0	1.5	2.0	2.5	3.0	3.5	4.0	4.5	5.0	6.0	7.0	8.0	9.0	10.0
10	0.5 (1.0)	0.5 (1.0)	0.5 (1.0)	0.5 (2.0)	0.5 (2.0)	0.5 (2.0)	0.5 (2.0)	0.5 (2.0)	0.5 (2.0)	0.5 (2.0)	0.5 (2.0)	0.5 (2.0)	1.0 (2.0)	1.0 (2.0)	1.0 (2.0)
20	0.5 (2.0)	1.0 (2.0)	1.0 (2.0)	1.0 (2.0)	1.0 (2.0)	1.0 (2.0)	1.0 (2.0)	1.5 (2.0)	1.5 (2.0)	1.5 (2.0)	1.5 (2.0)	1.5 (3.0)	1.5 (3.0)	1.5 (3.0)	1.5 (3.0)
30	1.0 (2.0)	1.5 (2.0)	1.5 (2.0)	1.5 (3.0)	1.5 (3.0)	1.5 (3.0)	2.0 (3.0)	2.0 (3.0)	2.0 (3.0)	2.0 (3.0)	2.0 (3.0)	2.0 (3.0)	2.0 (3.0)	2.0 (3.0)	2.0 (3.0)
40	1.5 (2.0)	1.5 (2.0)	2.0 (3.0)	2.0 (3.0)	2.0 (3.0)	2.0 (3.0)	2.5 (3.0)	2.5 (3.0)	2.5 (3.0)	2.5 (3.0)	2.5 (3.0)	2.5 (3.0)	2.5 (4.0)	2.5 (4.0)	2.5 (4.0)
50	1.5 (2.0)	2.0 (3.0)	2.5 (3.0)	2.5 (3.0)	2.5 (3.0)	2.5 (3.0)	2.5 (3.0)	2.5 (4.0)	3.0 (4.0)	3.0 (4.0)	3.0 (4.0)	3.0 (4.0)	3.0 (4.0)	3.0 (4.0)	3.0 (4.0)
55	2.0 (3.0)	2.5 (3.0)	2.5 (3.0)	2.5 (3.0)	2.5 (3.0)	3.0 (4.0)	3.0 (4.0)	3.0 (4.0)	3.0 (4.0)	3.0 (4.0)	3.0 (4.0)	3.0 (4.0)	3.0 (4.0)	3.0 (4.0)	3.0 (4.0)
60	2.0 (3.0)	2.5 (3.0)	2.5 (3.0)	3.0 (4.0)	3.0 (4.0)	3.0 (4.0)	3.0 (4.0)	3.0 (4.0)	3.0 (4.0)	3.0 (4.0)	3.0 (4.0)	3.0 (4.0)	3.5 (4.0)	3.5 (4.0)	3.5 (4.0)
65	2.0 (3.0)	2.5 (3.0)	3.0 (3.0)	3.0 (4.0)	3.0 (4.0)	3.0 (4.0)	3.0 (4.0)	3.5 (4.0)	3.5 (4.0)	3.5 (4.0)	3.5 (4.0)	3.5 (4.0)	3.5 (4.0)	3.5 (4.0)	3.5 (4.0)
70	2.5 (3.0)	3.0 (3.0)	3.0 (3.0)	3.0 (4.0)	3.5 (4.0)	3.5 (4.0)	3.5 (4.0)	3.5 (4.0)	3.5 (4.0)	3.5 (4.0)	3.5 (4.0)	3.5 (4.0)	3.5 (4.0)	3.5 (4.0)	3.5 (4.0)
75	2.5 (3.0)	3.0 (3.0)	3.0 (3.0)	3.5 (4.0)	3.5 (4.0)	3.5 (4.0)	3.5 (4.0)	3.5 (4.0)	3.5 (4.0)	3.5 (4.0)	3.5 (4.0)	3.5 (4.0)	3.5 (4.0)	3.5 (4.0)	3.5 (4.0)
80	2.5 (3.0)	3.0 (3.0)	3.5 (4.0)	3.5 (4.0)	3.5 (4.0)	3.5 (4.0)	3.5 (4.0)	3.5 (4.0)	3.5 (5.0)	4.0 (5.0)	4.0 (5.0)	4.0 (5.0)	4.0 (5.0)	4.0 (5.0)	4.0 (5.0)

Table 22-5
WIND-GENERATED WAVE HEIGHTS AND (PERIODS)
FETCH LENGTHS WITH AVERAGE DEPTHS = 15 FEET

Wind Speed (mph)	Fetch Length (miles)														
	0.5	1.0	1.5	2.0	2.5	3.0	3.5	4.0	4.5	5.0	6.0	7.0	8.0	9.0	10.0
10	0.5 (1.0)	0.5 (1.0)	0.5 (1.0)	0.5 (2.0)	0.5 (2.0)	0.5 (2.0)	0.5 (2.0)	0.5 (2.0)	0.5 (2.0)	0.5 (2.0)	0.5 (2.0)	1.0 (2.0)	1.0 (2.0)	1.0 (2.0)	1.0 (2.0)
20	0.5 (2.0)	1.0 (2.0)	1.0 (2.0)	1.0 (2.0)	1.0 (2.0)	1.5 (2.0)	1.5 (2.0)	1.5 (2.0)	1.5 (2.0)	1.5 (2.0)	1.5 (2.0)	1.5 (3.0)	1.5 (3.0)	2.0 (3.0)	2.0 (3.0)
30	1.0 (2.0)	1.5 (2.0)	1.5 (2.0)	1.5 (3.0)	2.0 (3.0)	2.0 (3.0)	2.0 (3.0)	2.0 (3.0)	2.0 (3.0)	2.0 (3.0)	2.5 (3.0)	2.5 (3.0)	2.5 (3.0)	2.5 (3.0)	2.5 (3.0)
40	1.5 (2.0)	2.0 (3.0)	2.0 (3.0)	2.0 (3.0)	2.5 (3.0)	2.5 (3.0)	2.5 (3.0)	2.5 (3.0)	3.0 (3.0)	3.0 (3.0)	3.0 (4.0)	3.0 (4.0)	3.0 (4.0)	3.0 (4.0)	3.0 (4.0)
50	2.0 (2.0)	2.0 (3.0)	2.5 (3.0)	2.5 (4.0)	3.0 (4.0)	3.0 (4.0)	3.0 (4.0)	3.5 (4.0)	3.5 (4.0)	3.5 (4.0)	3.5 (4.0)	3.5 (4.0)	3.5 (4.0)	3.5 (4.0)	4.0 (4.0)
55	2.0 (3.0)	2.5 (3.0)	3.0 (3.0)	3.0 (4.0)	3.0 (4.0)	3.5 (4.0)	3.5 (4.0)	3.5 (4.0)	3.5 (4.0)	3.5 (4.0)	4.0 (4.0)	4.0 (4.0)	4.0 (4.0)	4.0 (4.0)	4.0 (4.0)
60	2.0 (3.0)	2.5 (3.0)	3.0 (3.0)	3.5 (4.0)	3.5 (4.0)	3.5 (4.0)	3.5 (4.0)	4.0 (4.0)	4.0 (4.0)	4.0 (4.0)	4.0 (4.0)	4.0 (4.0)	4.0 (4.0)	4.0 (5.0)	4.5 (5.0)
65	2.5 (3.0)	3.0 (3.0)	3.5 (3.0)	3.5 (4.0)	3.5 (4.0)	4.0 (4.0)	4.0 (4.0)	4.0 (4.0)	4.0 (4.0)	4.0 (4.0)	4.5 (4.0)	4.5 (4.0)	4.5 (4.0)	4.5 (5.0)	4.5 (5.0)
70	2.5 (3.0)	3.0 (3.0)	3.5 (4.0)	4.0 (4.0)	4.0 (4.0)	4.0 (4.0)	4.0 (4.0)	4.5 (4.0)	4.5 (4.0)	4.5 (4.0)	4.5 (5.0)	4.5 (5.0)	4.5 (5.0)	4.5 (5.0)	4.5 (5.0)
75	2.5 (3.0)	3.5 (3.0)	3.5 (4.0)	4.0 (4.0)	4.0 (4.0)	4.5 (4.0)	4.5 (4.0)	4.5 (4.0)	4.5 (4.0)	4.5 (4.0)	4.5 (5.0)	5.0 (5.0)	5.0 (5.0)	5.0 (5.0)	5.0 (5.0)
80	3.0 (3.0)	3.5 (4.0)	4.0 (4.0)	4.0 (4.0)	4.5 (4.0)	4.5 (4.0)	4.5 (4.0)	4.5 (5.0)	5.0 (5.0)	5.0 (5.0)	5.0 (5.0)	5.0 (5.0)	5.0 (5.0)	5.0 (5.0)	5.0 (5.0)

Table 8
WIND-GENERATED WAVE HEIGHTS AND (PERIODS)
FETCH LENGTHS WITH AVERAGE DEPTHS = 20 FEET

Wind Speed (mph)	Fetch Length (miles)														
	0.5	1.0	1.5	2.0	2.5	3.0	3.5	4.0	4.5	5.0	6.0	7.0	8.0	9.0	10.0
10	0.5 (1.0)	0.5 (1.0)	0.5 (1.0)	0.5 (2.0)	0.5 (2.0)	0.5 (2.0)	0.5 (2.0)	0.5 (2.0)	0.5 (2.0)	0.5 (2.0)	1.0 (2.0)	1.0 (2.0)	1.0 (2.0)	1.0 (2.0)	1.0 (2.0)
20	0.5 (2.0)	1.0 (2.0)	1.0 (2.0)	1.0 (2.0)	1.0 (2.0)	1.5 (2.0)	1.5 (2.0)	1.5 (3.0)	1.5 (3.0)	1.5 (3.0)	1.5 (3.0)	1.5 (3.0)	2.0 (3.0)	2.0 (3.0)	2.0 (3.0)
30	1.0 (2.0)	1.5 (2.0)	1.5 (3.0)	1.5 (3.0)	2.0 (3.0)	2.0 (3.0)	2.0 (3.0)	2.0 (3.0)	2.5 (3.0)	2.5 (3.0)	2.5 (3.0)	2.5 (3.0)	3.0 (3.0)	3.0 (4.0)	3.0 (4.0)
40	1.5 (2.0)	2.0 (3.0)	2.0 (3.0)	2.5 (3.0)	2.5 (3.0)	2.5 (3.0)	3.0 (3.0)	3.0 (4.0)	3.0 (4.0)	3.0 (4.0)	3.5 (4.0)	3.5 (4.0)	3.5 (4.0)	3.5 (4.0)	3.5 (4.0)
50	2.0 (3.0)	2.5 (3.0)	2.5 (3.0)	3.0 (4.0)	3.0 (4.0)	3.5 (4.0)	3.5 (4.0)	3.5 (4.0)	3.5 (4.0)	4.0 (4.0)	4.0 (4.0)	4.0 (4.0)	4.0 (4.0)	4.5 (4.0)	4.5 (4.0)
55	2.0 (3.0)	2.5 (3.0)	3.0 (3.0)	3.0 (4.0)	3.5 (4.0)	3.5 (4.0)	4.0 (4.0)	4.0 (4.0)	4.0 (4.0)	4.0 (4.0)	4.5 (4.0)	4.5 (4.0)	4.5 (5.0)	4.5 (5.0)	4.5 (5.0)
60	2.0 (3.0)	3.0 (3.0)	3.0 (4.0)	3.5 (4.0)	4.0 (4.0)	4.0 (4.0)	4.0 (4.0)	4.0 (4.0)	4.5 (4.0)	4.5 (4.0)	4.5 (5.0)	5.0 (5.0)	5.0 (5.0)	5.0 (5.0)	5.0 (5.0)
65	2.5 (3.0)	3.0 (3.0)	3.5 (4.0)	4.0 (4.0)	4.0 (4.0)	4.5 (4.0)	4.5 (4.0)	4.5 (4.0)	4.5 (4.0)	5.0 (5.0)	5.0 (5.0)	5.0 (5.0)	5.0 (5.0)	5.0 (5.0)	5.5 (5.0)
70	2.5 (3.0)	3.5 (4.0)	4.0 (4.0)	4.0 (4.0)	4.5 (4.0)	4.5 (4.0)	4.5 (4.0)	5.0 (5.0)	5.0 (5.0)	5.0 (5.0)	5.0 (5.0)	5.5 (5.0)	5.5 (5.0)	5.5 (5.0)	5.5 (5.0)
75	3.0 (3.0)	3.5 (4.0)	4.0 (4.0)	4.5 (4.0)	4.5 (4.0)	5.0 (4.0)	5.0 (5.0)	5.0 (5.0)	5.0 (5.0)	5.5 (5.0)	5.5 (5.0)	5.5 (5.0)	5.5 (5.0)	6.0 (5.0)	6.0 (5.0)
80	3.0 (3.0)	4.0 (4.0)	4.5 (4.0)	4.5 (4.0)	5.0 (4.0)	5.0 (5.0)	5.5 (5.0)	5.5 (5.0)	5.5 (5.0)	5.5 (5.0)	5.5 (5.0)	6.0 (5.0)	6.0 (5.0)	6.0 (5.0)	6.0 (5.0)

TABLE 22-7 ESTIMATED WEIGHT OF ARMOR STONE		TABLE 22-8 CORRECTION FOR SLOPE		TABLE 22-9 CORRECTION FOR UNIT WEIGHT	
WAVE HEIGHT H (ft)	ESTIMATED WEIGHT W (lb)	SLOPE (ft/ft)	CORRECTION FACTOR K ₁	UNIT WEIGHT w _r (lb/ft ³)	CORRECTION FACTOR K ₂
0.5	1	1:2	1.0	120	4.3
1.0	10	1:2½	0.8	130	2.8
1.5	20	1:3	0.7	135	2.4
2.0	50	1:3½	0.6	140	2.0
2.5	100	1:4	0.5	145	1.7
3.0	160	1:4½	0.4	150	1.5
3.5	260	1:5	0.4	155	1.3
4.0	390	1:5½	0.4	160	1.1
4.5	550	1:6	0.3	165	1.0
5.0	750			170	0.9
5.5	1000			175	0.8
6.0	1300			180	0.7
6.5	1650			185	0.6
7.0	2100			190	0.6

EXAMPLE

GIVEN: The wave height (H) is 3.0 feet and the structure slope is 1 on 3 (1 Vertical on 3 Horizontal) and one cubic foot of rock weighs 155 lbs (w_r)

FIND: The required weight of armor stone (W) from the tables (Dashed Line)

$$W = 160 \text{ lbs} \times 0.7 \times 1.3 = 145 \text{ lbs}$$

Curve 22-7

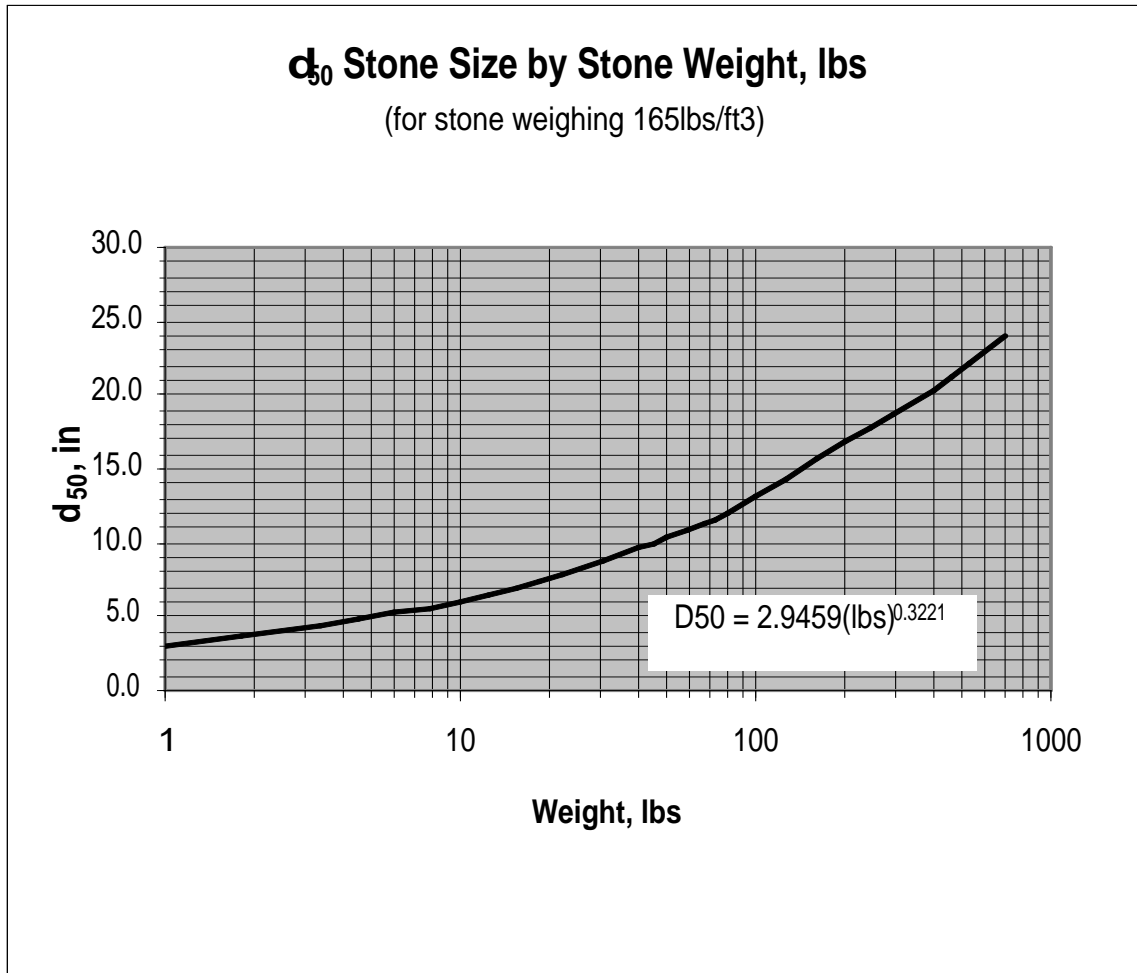

**STANDARD
FOR
SEDIMENT BARRIERS**

Definition

A temporary barrier installed across or at the toe of a slope.

Purpose

The purpose of a sediment barrier is to intercept and detain small amounts of sediment from unprotected areas of limited extent.

Conditions Where Practice Applies

The sediment barrier is used where:

1. No other practice is feasible,
2. There is no concentration of water in a channel or other drainage way above the barrier, and
3. Erosion would occur in the form of sheet and rill erosion.

Design Criteria

A. All types of sediment barriers:

1. Contributing drainage area is less than 1 acre and the length of slope above the barrier is less than 150 feet.
2. The slope of the contributing drainage area for at least 30 feet adjacent to the barrier shall not exceed 5%.
3. The barrier shall be constructed so water cannot bypass the barrier around the ends.
4. Inspection shall be frequent and repair or replacement shall be made promptly as needed.
5. The barrier shall be removed when the contributing drainage area has been stabilized so as not to block or impede storm flow or drainage.

B. Requirements for bale barrier (e.g., straw, hay, or other acceptable vegetative material):

1. All bales shall be securely tied and staked on the contour (Fig. 23-1).
2. Bales shall be placed in a row with ends tightly abutting the adjacent bales.
3. Each bale shall be embedded in the soil a minimum of 4 inches.
4. Bales shall be securely anchored in place by two stakes or re-bars driven through each bale. The first stake in each bale shall be driven toward previously laid bale to force bales together.

C. Requirements for silt fence:

1. Fence posts shall be spaced 8 feet center-to-center or closer. They shall extend at least 2 feet into the ground and extend at least 2 feet above ground (Fig. 23-2). Posts shall be constructed of hardwood with a minimum diameter thickness of 1 ½ inches.
2. **“Super” silt fence** - A metal fence with 6 inch or smaller mesh openings and at least 2 feet high may be utilized, fastened to the fence posts, to provide reinforcement and support to the geotextile fabric. Posts may be spaced less than 8 feet on center and may be constructed of heavier wood or metal as needed to withstand heavier sediment loading. This practice is appropriate where space for other practices is limited and heavy sediment loading is expected. “Super” silt fence is not to be used in place of properly designed diversions (pg. 15-1) which may be needed to control surface runoff rates and velocities.
3. A geotextile fabric, recommended for such use by the manufacturer, shall be buried at least 6 inches deep in the ground. The fabric shall extend at least 2 feet above the ground. The fabric must be securely fastened to the posts using a system consisting of metal fasteners (nails or staples) and a high strength reinforcement material (nylon webbing, grommets, washers etc.) placed between the fastener and the geotextile fabric. The fastening system shall resist tearing away from the post. The fabric shall incorporate a drawstring in the top portion of the fence for added strength.

D. Requirements for stone barrier:

1. The stone shall be piled to a natural angle of repose with a height of at least 2 feet.
2. The stone shall meet ASTM C-33 size No. 2 (2.5 to 1.5) or 3 (2 to 1 inch).

Maintenance

1. Sediment shall be removed from the upstream face of the barrier when it has reached a depth of ½ the barrier height.
2. Repair or replace barrier (fabric, posts, bales etc.) when damaged.
3. Barriers shall be inspected daily for signs of deterioration and sediment removal.

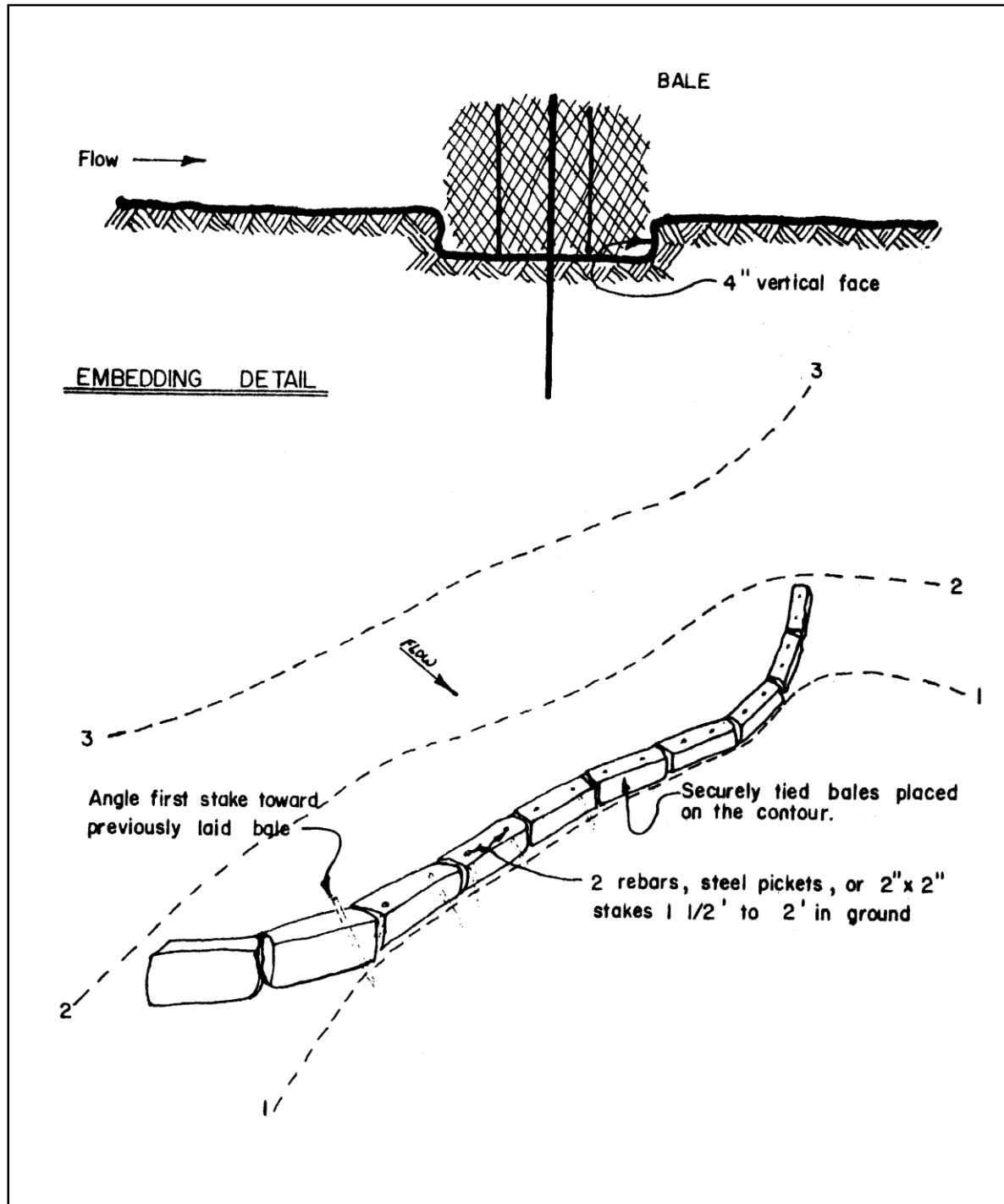
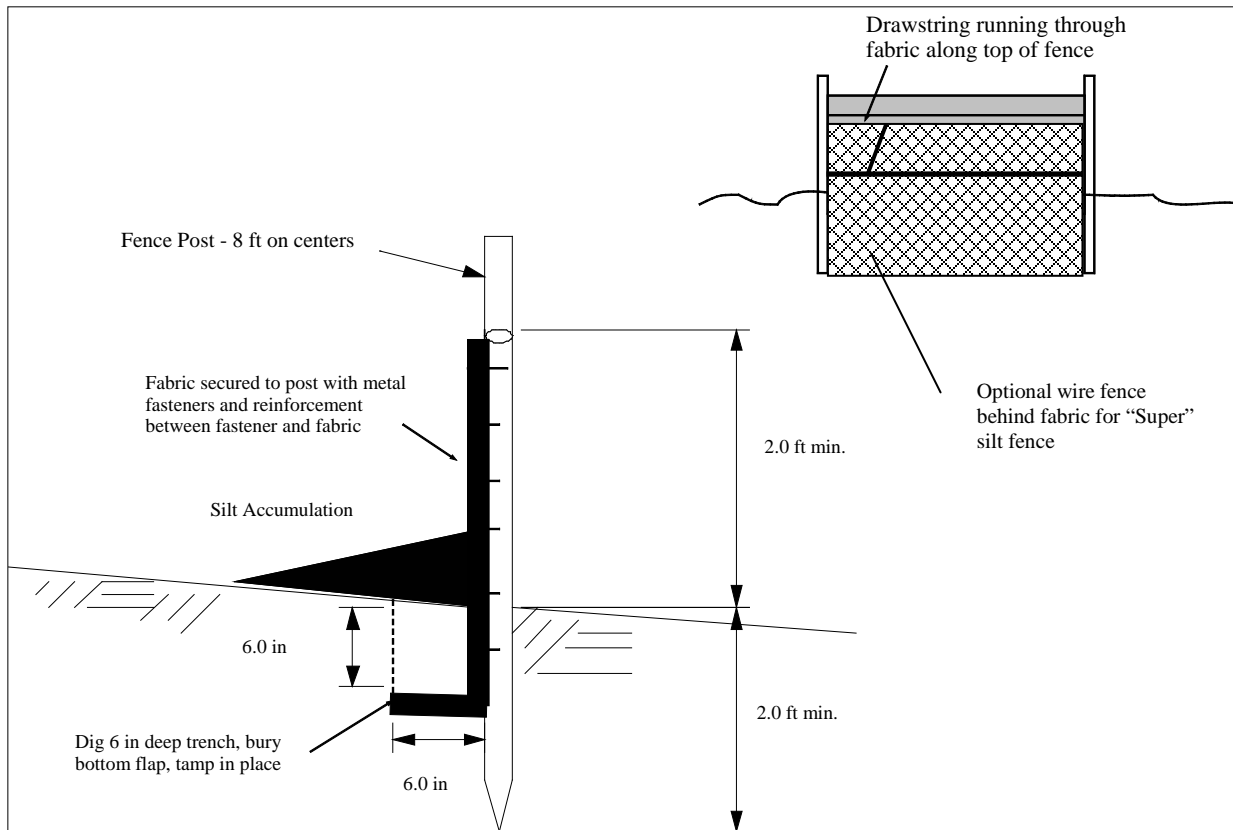

Figure 23-1: Placement and Anchoring Detail Bale Sediment Barriers

Figure 23-2: Silt Fence construction and installation detail



**STANDARD
FOR
SEDIMENT BASIN**

Definition

A barrier, dam, excavated pit, or dugout constructed across a waterway or at other suitable locations to intercept and retain sediment.

Basins created by construction of dams or barriers are referred to as "Embankment Sediment Basins" and those constructed by excavation as "Excavated Sediment Basins." Basins resulting from both excavation and embankment construction are classified as "Embankment Sediment Basins" where the depth of water impounded against the embankment at the emergency spillway elevation is 3 feet or more.

Scope

The standard covers the installation of sediment basins on sites where:

1. Failure of the sediment basin should not, within reasonable expectations, result in loss of life.
2. Failure of the sediment basin would not result in damage to homes, commercial or industrial buildings, main highways, or railroads; or interrupt the use or service of public utilities.
3. The drainage area is 320 acres or less.
4. The effective height of the dam is 20 feet or less. The effective height of the dam is defined as the difference in elevation in feet between the emergency spillway crest and the lowest point in the cross section taken along the centerline of the dam. If there is no emergency spillway, the top of the dam becomes the upper limit.

Sediment basins that are not within the above scope shall be designed to meet the criteria in "Earth Dams and Reservoirs, Technical Release 60" (TR60) by the USDA-NRCS.

For dams which raise the water elevation five (5) feet or greater in height as defined in NJAC 7:20, the rules and regulations established by the New Jersey Department of Environmental Protection, Division of Engineering and Construction, Dam Safety, shall apply for all structural criteria. Flood Hazard Area Regulations NJAC 7:13-1.1 et. seq. may also apply.

Purpose

To preserve the capacity of reservoirs, ditches, canals, diversions, storm sewers, waterways, and streams; to prevent undesirable deposition on bottom-lands and developed areas; to trap sediment originating from critically eroding areas and construction sites; and to reduce or abate pollution by providing basins for deposition and storage of silt, sand, gravel, and stone.

Conditions Where Practice Applies

This practice applies where physical conditions, land ownership, or construction operations preclude the treatment

of the sediment source by the installation or erosion control measures to keep soil and other material in place, or a sediment basin offers the most practical solution to the problem. The effectiveness of sediment removal is greatly reduced when soils are highly colloidal in nature. Additional source controls (stabilization) or flocculants must be utilized to reduce the delivery of fines to the sediment basin.

Water Quality Enhancement

During the construction process, large areas of bare soil are frequently exposed to erosion due to stormwater runoff. Suspended soils can contribute significantly to degraded water quality, both from downstream deposition as well as acting as a carrier for other pollutants which may adsorb onto soil particles. The use of a properly designed sediment basin, in combination with other erosion control standards can significantly reduce both volumetric and pollution transport problems associated with soil erosion from construction sites.

Design Criteria

Structural aspects of detention basins shall be as stipulated by applicable state, county or municipal requirements. In the absence of such criteria, Appendix A-10, "Structural Guidelines for Detention Basins", may be used. In addition, it must be shown for the peak outflow of a 10 year, 24 hour storm event (over and above basin design storage) as determined by Win TR-55, Win TR-20, USACOE HEC HMS or other comparable methods, that there will be no soil erosion and sedimentation problems offsite. A detailed hydraulic analysis of the basin shall be submitted.

1. Sediment Basin Location:

The basin shall be designed to accommodate the individual storm runoff and sediment accumulation from the basin's total drainage area.

The basin should be located as much as possible:

- a. To intercept only runoff from disturbed areas.
- b. To minimize disturbance from its own construction.
- c. To obtain maximum storage benefit from the terrain.
- d. For ease of cleanout of the trapped sediment.
- e. To minimize interference with other construction activities and construction of utilities.

2. Shape and Depth:

The length, width, and depth are measured at the principal spillway crest elevation. The basin configuration shall be such that the effective flow length is equal to at least two times the effective flow width. This basin shape may be attained by selecting the basin site, by excavating the basin to the required shape or by the installation of one or more baffles.

The minimum width shall be:

$$W = 10 \times (Q_5)^{1/2}$$

where: W = the width in ft.

Q₅ = peak discharge from a 5 year frequency storm in cfs.

The average depth shall be at least 4 feet.

When downstream damage may be severe, the minimum width should be:

$$W = 10 \times (Q_{25})^{1/2}$$

where: W = width in feet

Q₂₅ = peak discharge from a 25 year frequency storm in cfs.

The average depth shall be at least 4 feet.

See Appendix A-10 for Structural Guidelines for basins.

3. Outlet for Conduits

Protection against scour at the discharge end of the spillway shall be provided in accordance with the Standard for Conduit Outlet Protection, pg. 12-1, or by suitable hydraulic structures proven effective by properly documented research.

4. Vegetation

The dam, emergency spillway, spill and borrow areas, and other disturbed areas above crest of the principal spillway shall be stabilized in accordance with the standards for temporary (pg. 7-1) or permanent (pg. 4-1) vegetative cover, whichever is applicable.

Sediment Basin Sizing

A. Sediment Basin Volume

The volume in the sediment basin below the crest elevation of the emergency spillway shall be the larger of:

1. The volume necessary to obtain 70% trap efficiency at the start of the basin's useful life, or
2. The volume necessary to provide sediment storage capacity and provide for temporary stormwater runoff storage from a 2-year frequency, 24-hour duration, Type III storm.

Flood routing to determine the required temporary floodwater storage for a 2-year frequency, 24-hour duration, Type III storm shall be done using the approximate methods in the USDA-NRCS "Engineering Field Manual," the approximate methods in the USDA-NRCS "Urban Hydrology for Small Watersheds" (Win TR55), Win TR-20, or other generally accepted methods of flood routing.

The Modified Rational Method on a drainage basin up to 20 acres, as described in Special Report 43 by the American Public Works Association, Practices in Detention of Urban Stormwater, is also applicable.

1. Trap Efficiency

Trap efficiency is the amount, in percent, of the sediment delivered to the sediment basin that will remain in the basin. The sediment basin shall have adequate volume below the crest of the emergency spillway to have an actual trap efficiency of at least 70% at the start of its useful life using Curve 26-1 and with:

C = total capacity of the sediment basin up to the crest elevation of the emergency spillway in acre feet.

I = average annual surface runoff from Figure 26-1 converted to units of acre feet.

For a normally dry sediment basin, the actual trap efficiency is reduced 10% where the incoming sediment is predominately silt, clay, or fine grained. Therefore, enter Curve 26-1 with 80% trap efficiency to achieve 70% actual trap efficiency. For a normally dry sediment basin, the actual trap efficiency is reduced 5% where the incoming sediment is sand or coarse grained. Therefore, enter Curve 26-1 with 75% trap efficiency to achieve 70% actual trap efficiency.

2. Sediment Storage Capacity plus 2 Year Storm Runoff Volume

The sediment storage capacity of a sediment basin shall equal the volume of sediment expected to be trapped at the site during the planned useful life of the sediment basin. Where it is determined that periodic removal of sediment is practicable, the sediment storage capacity may be proportionately reduced. Planned periodic removal of sediment shall not be more frequent than once a year. The capacity shall be determined by one of the following methods:

Provide sediment storage based on the following formula and figures:

$$V = (DA)(A)(DR)(TE)(1/\gamma_s) (2,000 \text{ lbs./tons})(1/43560 \text{ sq. ft./Ac.})$$

where:

V = the volume of sediment trapped in Ac. ft./yr.

DA = the total drainage area in acres.

A = the average annual erosion in tons per acre per year using the values below for the listed land use

Average Annual Erosion by Land Use Type

LAND USE	AVERAGE ANNUAL EROSION
Wooded areas	0.2 ton/ac/yr
Developed urban areas, grassed areas, pastures, hay fields, abandoned fields with good cover	1.0 ton/ac/yr
Clean tilled cropland (corn, soybeans, etc.)	10 ton/ac/yr
Construction areas	50 ton/ac/yr

DR = the delivery ratio determined from Curve 26-2

TE = the trap efficiency as determined above.

γ = the estimated sediment density in the sediment basin in lbs/cu. ft. (See Table 26-1).

γ_s = the submerged density in a wet sediment pool.

γ_a = the aerated density in a normally dry sediment pool.

TABLE 24-1 Soil Densities by Soil Type

SOIL TEXTURE	γ_s Submerged (lbs./cu.ft.)	γ_s Aerated (lbs./cu.ft.)
Clay	40-60	60-80
Silt	55-75	75-85
Clay-silt mixtures (equal parts)	40-65	65-85
Sand-silt mixtures (equal parts)	75-95	95-100
Clay-silt-sand mixtures (equal parts)	50-80	80-100
Sand	85-100	85-100
Gravel	85-125	85-125
Poorly sorted sand and gravel	95-130	95-130

The NRCS Type III 2 year Storm Runoff Volume draining to the Sediment Basin shall be added to the Sediment Storage Capacity to arrive at the total storage volume for the Sediment Basin under this criteria.

B. Sediment Basin Outlets:

1. **Dewatering Hole:**

If the sediment basin is de-watered by using a hole in the riser:

- a. The elevation of the hole shall be the elevation that results in 50% actual trap efficiency in the basin. The value for C used to determine the 50% actual trap efficiency is the capacity of the basin between the bottom of the basin and the invert of the dewatering hole. The riser shall be completely watertight except for the inlet at the top and one hole 4 inches or less in diameter to de-water the basin.
- b. The sediment shall be removed from the basin when the sediment reaches the elevation of the bottom of the hole.
- c. A ‘skimmer’ or ‘floating riser’ may be utilized to draw down cleaner water from the water surface. The flexible connection to the outlet control structure must be water tight. Provision must be made to prevent the skimmer from resting on the basin floor when the pool has been completely drained. See Appendix A-7 for general details.

If the Sediment Basin has a permanent pool:

- a. De-watering the Sediment Basin - Sediment basins with a permanent pool of water trap sediment more effectively than basins that are normally dry and usually create less of a mosquito problem and safety hazard. Therefore, a sediment basin with a permanent pool is usually a better design than a normal dry sediment basin.

If a normally dry or partially dry sediment basin is planned, the basin shall be de-watered by methods depicted above and in appendix A7.

If the sediment basin is de-watered by using a subsurface drain, it shall be in accordance with the Subsurface Drain Standard, pg. 32-1 and appendix A-7.

A flocculent such as ‘PAM’ (Polyacrylamide) may be added to the basin in accordance with manufacturer’s instructions to remove fine suspended colloidal material prior to dewatering. All

dewatering discharges must be to a stabilized location. A source of free cationic ions (such as Ca 2+) may be required at a rate of 50- 60 gm Ca2+ /kg PAM to encourage bonding between colloids and PAM. Materials such as lime, CaCl, gypsum or flyash may be used to provide the cation component. The flocculent shall not cause adverse environmental conditions to develop in the area receiving the basin discharge.

Flocculent may be added through the use of ‘logs’ or similar devices impregnated with PAM to dose inflow water prior to entrance to the sediment basin. Such devices shall be placed to allow complete passage of the design storm and shall not obstruct flow through storm sewer systems.

2. Principal Spillway Crest Elevation – Top of Temporary Sediment Riser:

The principal spillway crest elevation shall be the lower of:

- a. one (1) foot below the emergency spillway crest elevation or,
- b. the elevation that provides (between the crest of the principal spillway and the crest of the emergency spillway), the required temporary floodwater storage for a 2-year frequency, 24-hour duration, Type III storm.

3. Emergency Spillways for Excavated and Embankment Sediment Basins:

Emergency spillways are provided to convey large floods safely past sediment basins.

An emergency spillway must be provided for each sediment basin, unless the principal spillway is large enough to pass the routed emergency spillway design storm and the trash that comes to it without overtopping the dam. A closed conduit principal spillway having a conduit with a cross-sectional area of 3 square feet or more, an inlet which will not clog, and an elbow designed to facilitate the passage of trash is the minimum size and design that may be utilized without an emergency spillway.

- a. Excavated Sediment Basins - Excavated sediment basins may utilize the natural ground or the fill for the emergency spillway if the downstream slope is 5 to 1 or flatter, has existing vegetation, or is immediately protected by sodding, rock riprap, asphalt lining, concrete lining, or other equally effective protection. The spillway shall meet the capacity requirement for embankment sediment basins.
- b. Embankment Sediment Basins - Embankment sediment basins shall meet the following requirements:

Capacity - The minimum capacity of the emergency spillway shall be that required to pass the peak flow expected from a design storm of the frequency and duration shown in **Table 26-2** less any reduction creditable to conduit discharge and detention storage.

wrong table reference

When discharge of the principal spillway is considered in calculating outflow through the emergency spillway, the crest elevation of the inlet shall be such that full flow will be generated in the conduit before there is discharge through the emergency spillway. The emergency spillway shall safely pass the peak flow or the storm runoff shall be routed through the reservoir. If routed, the routing shall start with the water surface at the elevation of the crest of the principal spillway. The flood routing may be done using the approximate methods in the USDA-NRCS Engineering Field Manual; the USDA-NRCS TR-55 or TR-20; the modified rational method up to 20 acres, as described in Special Report 43 by the American Public Works Association, Practices in Detention of Urban Stormwater; or other accepted methods of emergency spillway flood routing.

Table 24-2 Minimum Design Storm

DRAINAGE AREA (acres)	FREQUENCY (years)	MINIMUM DURATION* (hours)
less than 20	10	24
21 - 49	25	24
over 49	100	24

*For use by USDA-NRCS methods only.

Disposal

The sediment basin plans shall indicate the method(s) of disposing of the sediment removed from the basin. The sediment shall be placed in such a manner that it will not erode from the site. The sediment shall not be deposited downstream from the basin, in or adjacent to a stream or floodplain or in wetlands.

The plans shall also show the method of removal of the sediment basin after the drainage area is stabilized, and shall include the stabilizing of the sediment basin site. Water lying over the trapped sediment shall be removed from the basin by pumping, cutting the top of the riser, or other appropriate method prior to removing or breaching the embankment. Sediment shall not be allowed to flush into the stream or drainage way.

Sediment shall be removed from the basin for maintenance purposes when the sediment level reaches the 50 % Trap Efficiency elevation. The elevation shall be identified either by the invert elevation of the 50 % Trap Efficiency dewatering hole (if one is used) or by a marker which shall be visible from the basin edge.

Safety - This portion of the Standard is for guidance only.

Sediment basins attract children and can be very dangerous. Local County or State ordinances and regulations regarding health and safety must be adhered to.

Maintenance

The plans shall indicate who is responsible for operation and maintenance during the life of the sediment basin.

CURVE 24-1

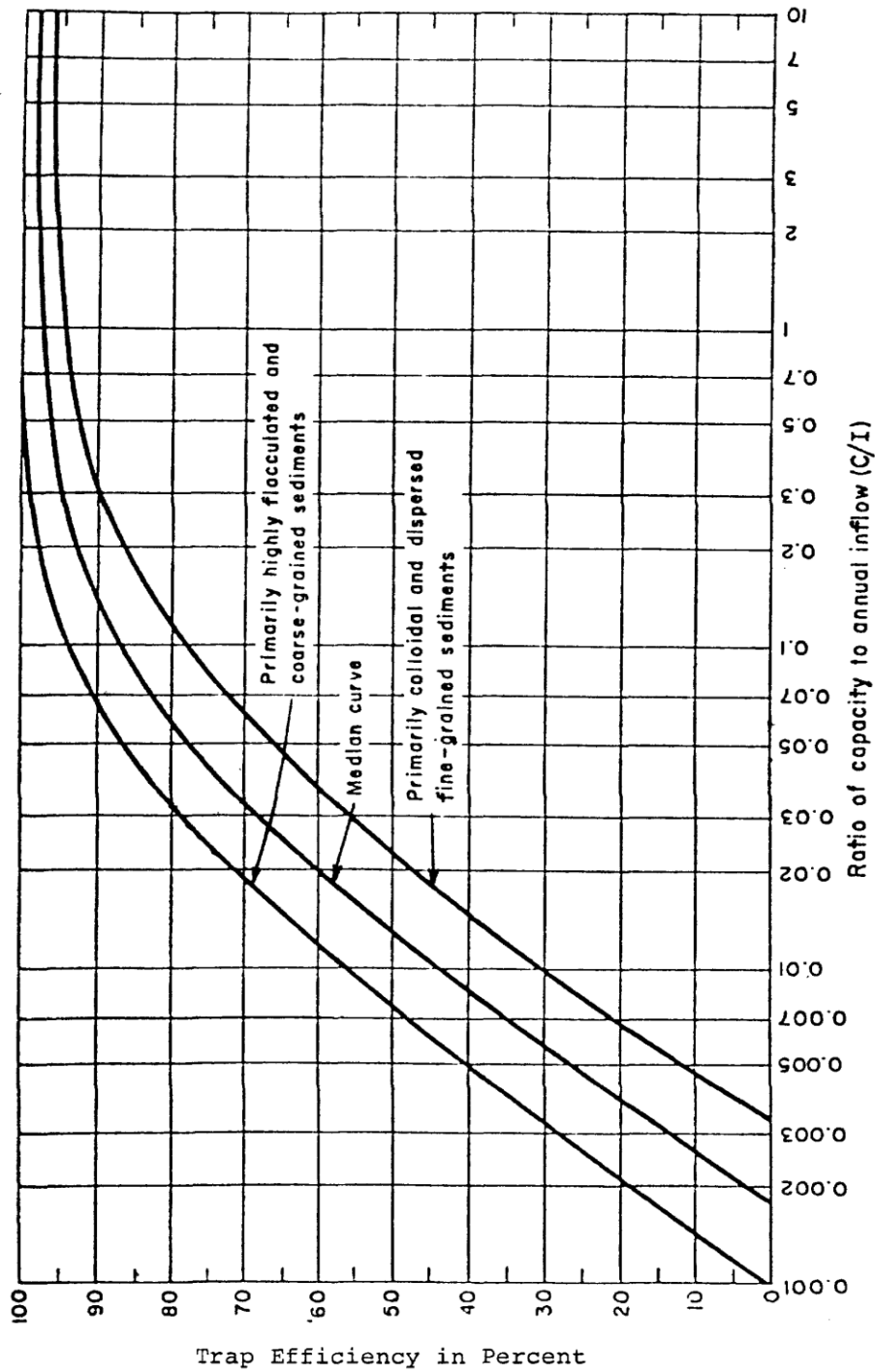

TRAP EFFICIENCY OF RESERVOIRS

Reference: Brune, Gunnar M., "Trap Efficiency of Reservoirs", Trans. AGU, Vol. 34, No.3, pp 407-418, June 1953.

FIGURE 24-1

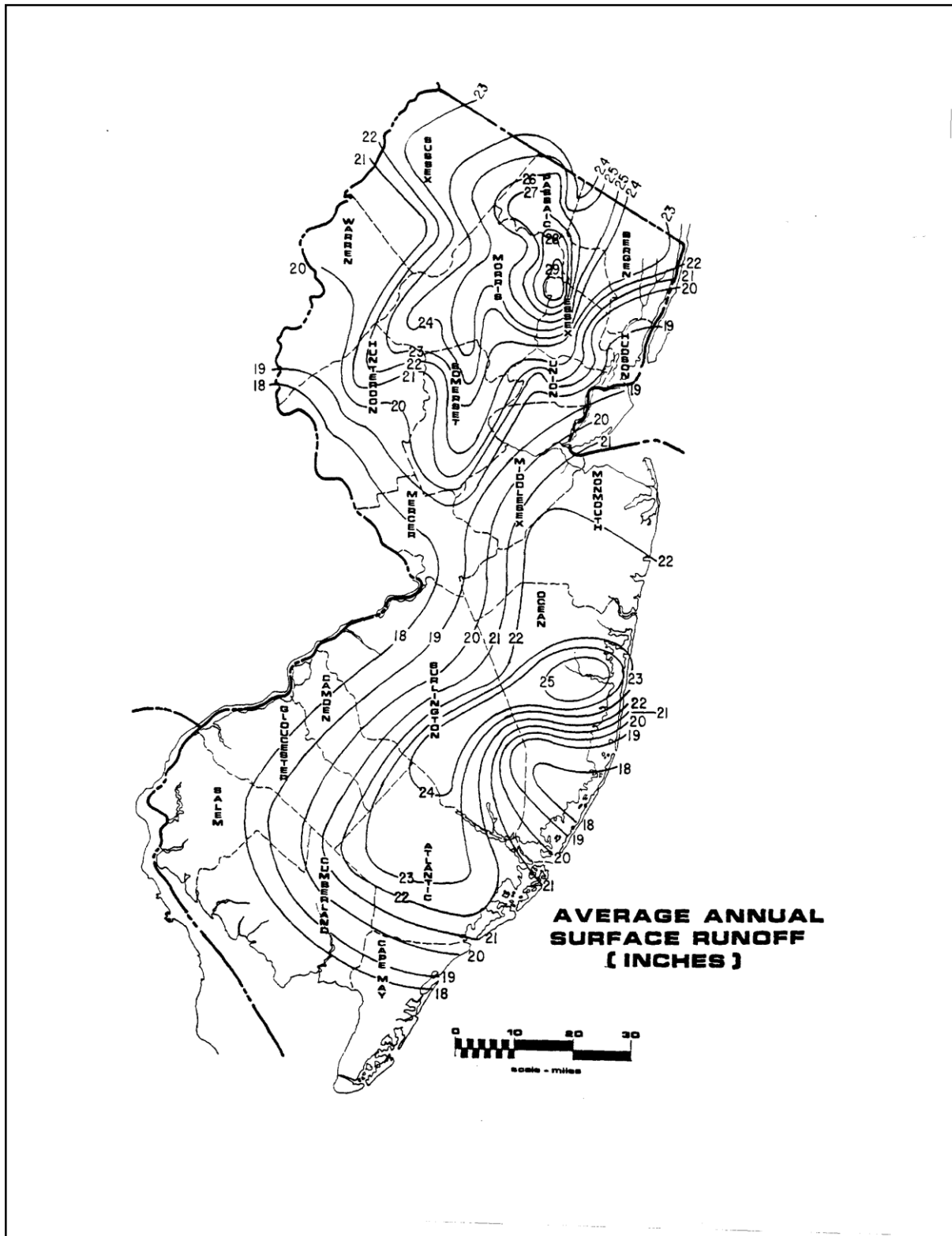

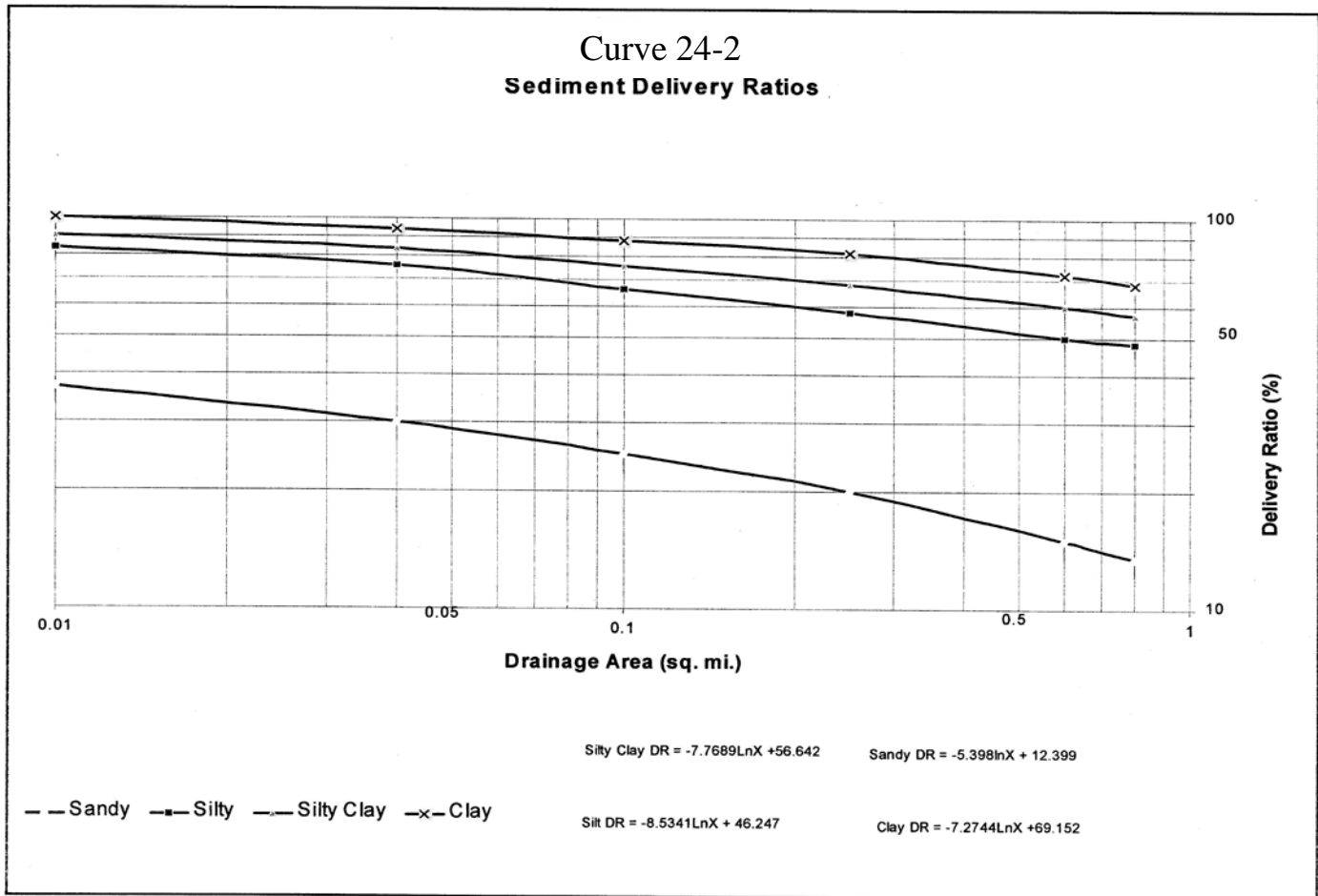

**STANDARD
FOR
SLOPE PROTECTION STRUCTURES**

Definition

Structures to safely conduct surface runoff from the top of a slope to the bottom of the slope.

Purpose

The purpose of this practice is to convey storm runoff safely down existing slopes and cut and fill slopes to minimize erosion.

Conditions Where Practice Applies

Slope protection structures are to be used where concentrated water will cause excessive erosion on existing and/or recent cut and fill slopes. Temporary structures shall be left in place until adequate vegetation and the permanent drainage system have been installed. Permanent structures are part of the drainage system.

Water Quality Enhancement

The primary benefit to water quality is through the prevention of steep slope erosion, by providing a means to safely convey stormwater runoff down to a stable area or condition. Total suspended solids discharged from the site, both during and after construction will be reduced.

Design Criteria

Open Flumes

Flumes shall be adequately designed to convey runoff water concentrations safely down steep slopes based on a 10 year frequency storm, the rational method for uniform drainage area up to one-half of a square mile, or sized in accordance with the requirements of Tables 25-1 and 25-2.

Protection against scour at the discharge end of the open flume shall be provided in the form of an energy dissipater or other measures such as an SAF, rock riprap revetment, or plunge pool.

Recommended dimensions for flumes are defined as follows:

1. b - is the bottom width of the paved down slope section of a trapezoidal or rectangular flume. The minimum bottom widths and associated maximum drainage areas shall conform to Table 25-1.
2. T - is the top width of parabolic flumes. The minimum top widths and maximum drainage areas shall conform to Table 25-2.
3. H - is the height of the dike at the entrance to the structure and shall be a minimum of 2.5 feet.
4. d - is the depth of the paved down slope section and shall be a minimum of 10 inches for trapezoidal or rectangular flumes. The depths of parabolic flumes shall be as shown in Table 25-2.
5. L - is the length of the inlet and outlet paved sections and each shall be a minimum of 6 feet.

The above dimensions are illustrated in Figure 25-1.

If a minimum of 75% of the drainage area will have a good grass or woodland cover throughout the life of the structure, the drainage areas listed in Tables 25-1 and 25-2 may be increased by 50%. If a minimum of 75% of the drainage area will have a good mulch cover throughout the life of the structure, the drainage area listed in Tables 25-1 and 25-2 may be increased by 25%.

Flumes with dimensions and associated drainage areas other than those shown in this standard shall be designed on an individual job basis. Capacities shall be determined by acceptable hydrologic and hydraulic computations, as noted under Pipe Drops of this Standard.

TABLE 25-1

FLUMES WITH TRAPEZOIDAL AND RECTANGULAR SECTIONS

Bottom Widths And Drainage Area For Trapezoidal Flumes With Flow Depths Equal to 10 Inches	
Bottom Width (feet)	Drainage Area (acres)
2	7
4	10
6	13
8	16
10	19
12	24

Bottom Widths And Drainage Area For Rectangular Flumes With Flow Depths Equal to 10 Inches	
Bottom Width (feet)	Drainage Area (acres)
2	3
4	5
6	10
8	13
10	16
12	20

Dikes to be 2.5 feet in height above flume entrance.

TABLE 25-2

FLUMES WITH PARABOLIC SECTIONS

Depths Equal to 1 Foot	
Top Width (feet)	Drainage Area (acres)
4	3
6	4
8	5
10	6
12	7
14	8

Depths Equal to 1.5 Feet	
Top Width (feet)	Drainage Area (acres)
4	4
6	5
8	5
10	7
12	8
14	10
16	11

Dikes to be 2.5 feet in height above flume entrance

Riprap Lined Chutes

Stable rock sizes and flow depths for riprap-lined channels having gradients between 2 percent and 40 percent may be determined using the following detailed design process from **Design of Rock Chutes** by Robinson, Rice, and Kadavy.

For channel slopes between 2% and 10%:

$$D_{50} = [q (S)^{1.5}/4.75(10)^{-3}]^{1/1.89}$$

For channel slopes between 10% and 40%:

$$D_{50} = [q (S)^{0.58}/3.93(10)^{-2}]^{1/1.89}$$

$$z = [n(q)/1.486(S)^{0.50}]^{3/5}$$

$$\text{where } n = 0.047(D_{50}S)^{0.147}$$

D_{50} = Particle (stone) size for which 50% of the sample is finer, in.

S = Bed slope, ft./ft.

z = Flow depth, ft.

q = Unit discharge, ft³/s/ft

(Total discharge÷Bottom width)

Except for short transition sections, flow in the range of 0.7 to 1.3 of the critical slope must be avoided unless the channel is straight. Velocities exceeding critical velocity shall be restricted to straight reaches. Maximum channel side slope shall not exceed 2:1 for this method.

Pipe Drops

The design capacity shall be as required to pass peak runoff from a 10-year frequency storm.

Peak discharge values shall be determined by the following:

1. Rational Method - for peak discharge of uniform drainage areas as outlined in Technical Manual for Land Use Regulation Program, Bureau of Inland and Coastal Regulations Stream Encroachment Permits, Trenton, N.J. September 1997 or subsequent editions
2. USDA-NRCS Win TR-55 or Win TR-20
3. U.S. Army Corps of Engineers HEC HMS
4. Other methods which produce similar results to the models listed above.

Pipe capacities may be determined from charts in Appendix 11, Chapter 6, Ref. (1), or other accepted sources.

A hood inlet type entrance should be used as shown in Figure 25-2. The pipe drop inlet shall be protected by riprap or concrete.

Outlet protection shall be provided by riprap or other means. Diversion dikes or deep curb cuts shall be used in conjunction with pipe drops. The dike height above the pipe inlet invert shall be adequate to contain a water

elevation sufficient to cause full pipe flow plus an allowance of at least 0.5 feet for freeboard. A minimum water depth of 1.8 times the pipe diameter above pipe inlet invert is required to assure full pipe flow.

Installation Requirements

1. The structure shall be placed on undisturbed soil or well-compacted fill.
2. The cut or fill slope shall not be steeper than 1 vertical to 1.5 horizontal (1.5:1) and should not be flatter than 20:1.
3. Adequate vegetative protection per vegetation standards and drainage works shall be installed.
4. Open Flume
 - a. The top of the earth dikes shall not be lower at any point than the top of the lining at the entrance of the structure.
 - b. The lining should be placed beginning at the lower end and proceeding up the slope to the upper end. The lining shall be well compacted and free of voids.
 - c. The entrance floor at the upper end of the structure shall have a slope toward the outlet of $\frac{1}{4}$ to $\frac{1}{2}$ inch per foot.
5. Hood Inlet Pipe Drops
 - a. The pipe shall be imbedded in the embankment to a depth that will insure stability.
 - b. Protection measures of concrete or riprap shall be installed at the inlet and outlet as needed to protect against erosion.
 - c. The pipe may be smooth or corrugated and shall be of the required strength and durability.
 - d. Backfill shall be carefully placed in layers and tamped to insure adequate compaction.
6. Outlet Protection in accordance with the Conduit Outlet Protection Standard, pg. 12-1.

Unconcentrated surface runoff from paved surfaces

A permanent vegetative cover shall be established through seeding or pegged (anchored) sod on all slopes receiving unconcentrated runoff from paved surfaces. Seeded slopes shall utilize a non-biodegradable turf reinforcement matting, installed in accordance with manufacturers instructions.

Slopes receiving unconcentrated surface flows shall not exceed those shown in the NJDEP Best Management Practices Manual, Chapter 9.10, Table 9.10-2 (reproduced below). An optional stone trench installed along the edge of pavement may be added to aid in the prevention of flow concentration. Maximum contributing drainage areas shall be as defined in Chapter 9.10 of the Manual.

For receiving **slopes that exceed** the thresholds designated in Table 9.10-2 of the BMP Manual, a properly designed slope protection structure must be provided in accordance with this Standard.

For receiving slopes with **contributing drainage areas that exceed** the thresholds defined in Chapter 9.10 of the BMP Manual, a properly designed slope protection structure must be provided in accordance with this Standard

If flows are to be directed and controlled via curb cuts, scuppers or other methods which will result in the concentration of flows., then a properly designed slope protection structure must be provided in accordance with this Standard.

**Maximum slopes for unconcentrated flows from paved surfaces
(reproduced from NJDEP BMP Manual Table 9.10-2)**

Soil type	Maximum Slope (percent)
Sand	7
Sandy Loam	8
Loam, Silt Loam	8
Sandy Clay Loam	8
Clay Loam, Silty Clay, Clay	8

Figure 25-1

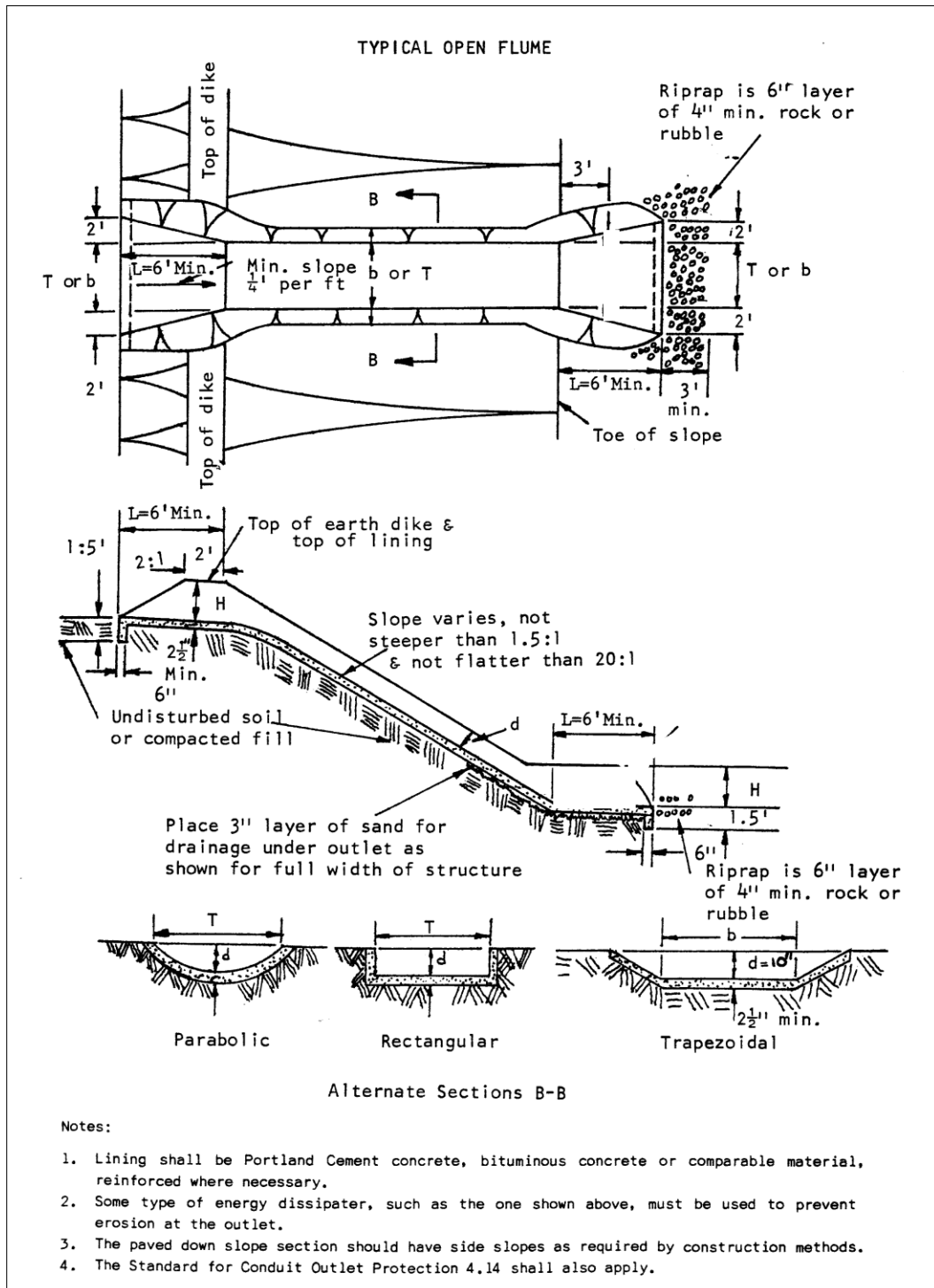

FIGURE 25-2

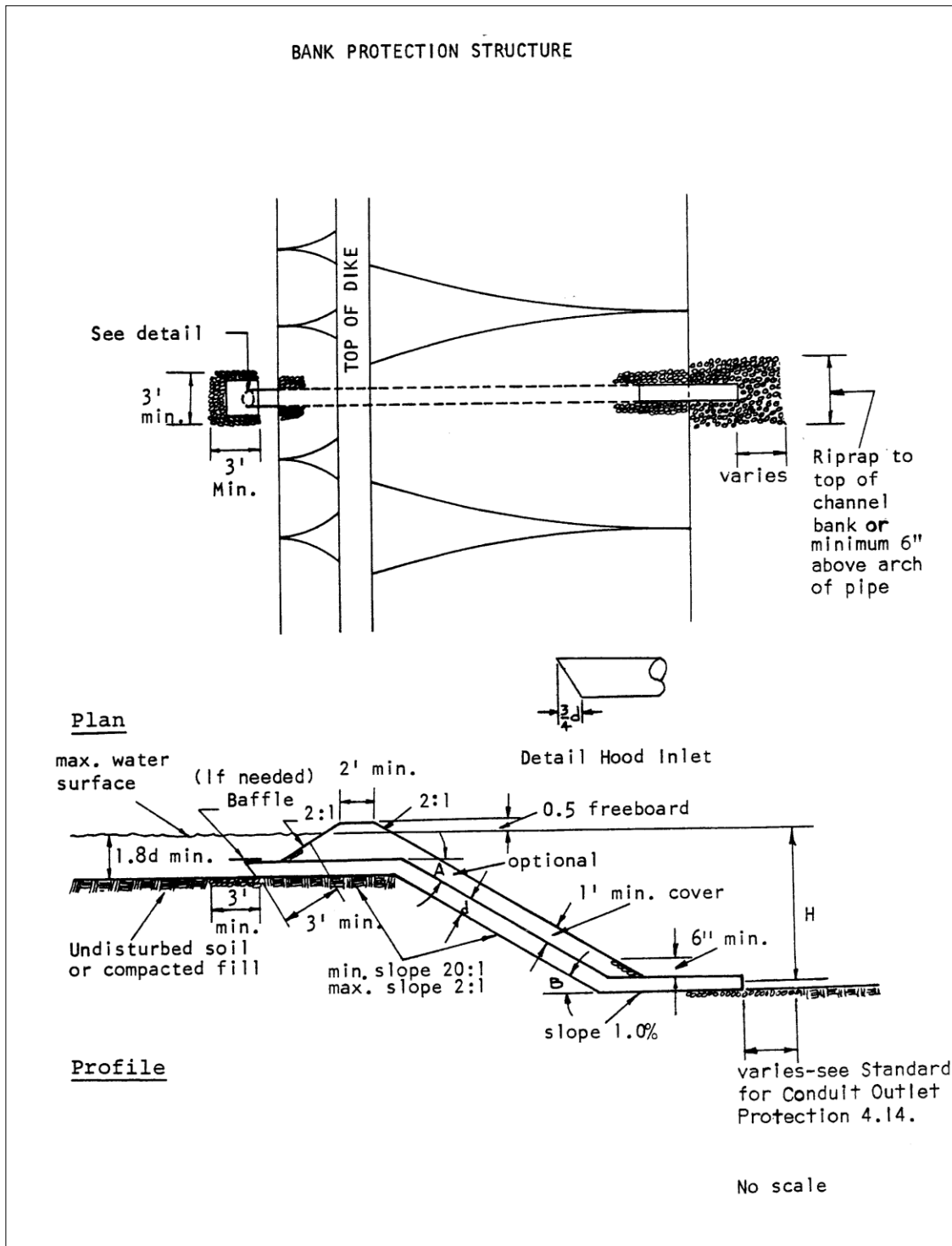
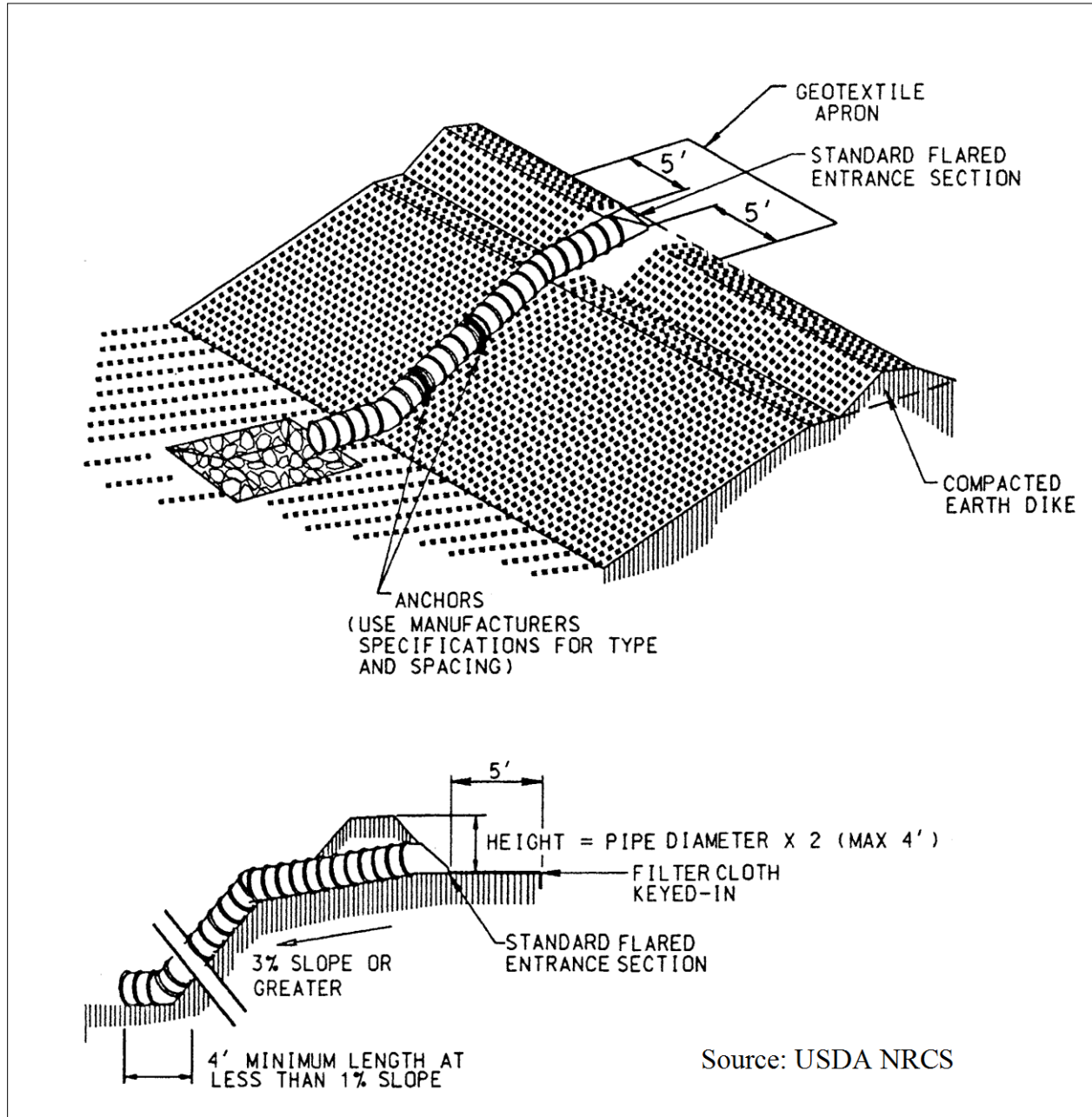

Figure 25-3: Pipe Slope Drain



Source: USDA NRCS

STANDARD FOR SOIL BIOENGINEERING

Definition

The use of live, woody and herbaceous plants to repair slope failures and to increase slope stability. Living plant material may be used alone or in combination with structural components such as rock, wood, concrete, or geotextiles.

Purpose

To integrate structural and vegetative techniques to stabilize or protect banks of streams, lakes, shorelines, excavated channels and upland slopes; to prevent the loss of land or damage to facilities adjacent to the banks; to maintain the capacity of the channel; to reduce sediment loads causing downstream damages and/or pollution; and to protect and enhance water quality.

Conditions Where Practices Applies

Soil bioengineering techniques are generally appropriate for treatment of slopes, eroded stream banks, surface erosion, shallow mass wasting, cut and fill slope stabilization, earth embankment protection (other than dams), and small gully repair. **They are not to be considered when public safety is at risk** such as when substantial mechanical and or structural designs are required.

Descriptions of methods for installing individual Soil Bioengineering systems may be found in USDA Natural Resources Conservation Service Engineering Field Handbook (EFH), **Chapter 16** (Streambank and Shoreline Protection) and **Chapter 18** (Upland slope Protection).

Water Quality Enhancement

The use of vegetative techniques to stabilize stream banks, upland slopes and open shorelines provides long term erosion control as well as contributing to water quality through uptake of nutrients, moderation of water temperature and protection of dissolved oxygen content (in surface waters).

DESIGN CRITERIA

1. PLANNING

Flow Chart No. 26-1 (Soil Bioengineering Application Decision Chart) shall be used to determine if Soil Bioengineering Techniques alone are appropriate for correcting existing erosion problems or for preventing future erosion of shorelines, upland slopes or stream channels. Bioengineering techniques may be used singularly or in combination with one another or in combination with other erosion control techniques, such as rip rap bank protection.

The following conditions must be evaluated to help ensure a proper soil bioengineering design:

- Soil type and moisture availability
- Stream bed stability
- Slope stability
- Surface runoff (diversion may be necessary to ensure success - see Standard for Diversions, pg. 15-1)

- Availability of bioengineering materials
- Effects of mature vegetation on stream hydraulics, including up and downstream of the treatment area
- Time of year for installation (installation of all woody vegetation shall be performed during the dormant season only)
- Cause of the loss of existing vegetation (ice damage, livestock damage, fire invasive species etc.)

Flow Chart No. 28-1
Soil Bioengineering Application Chart

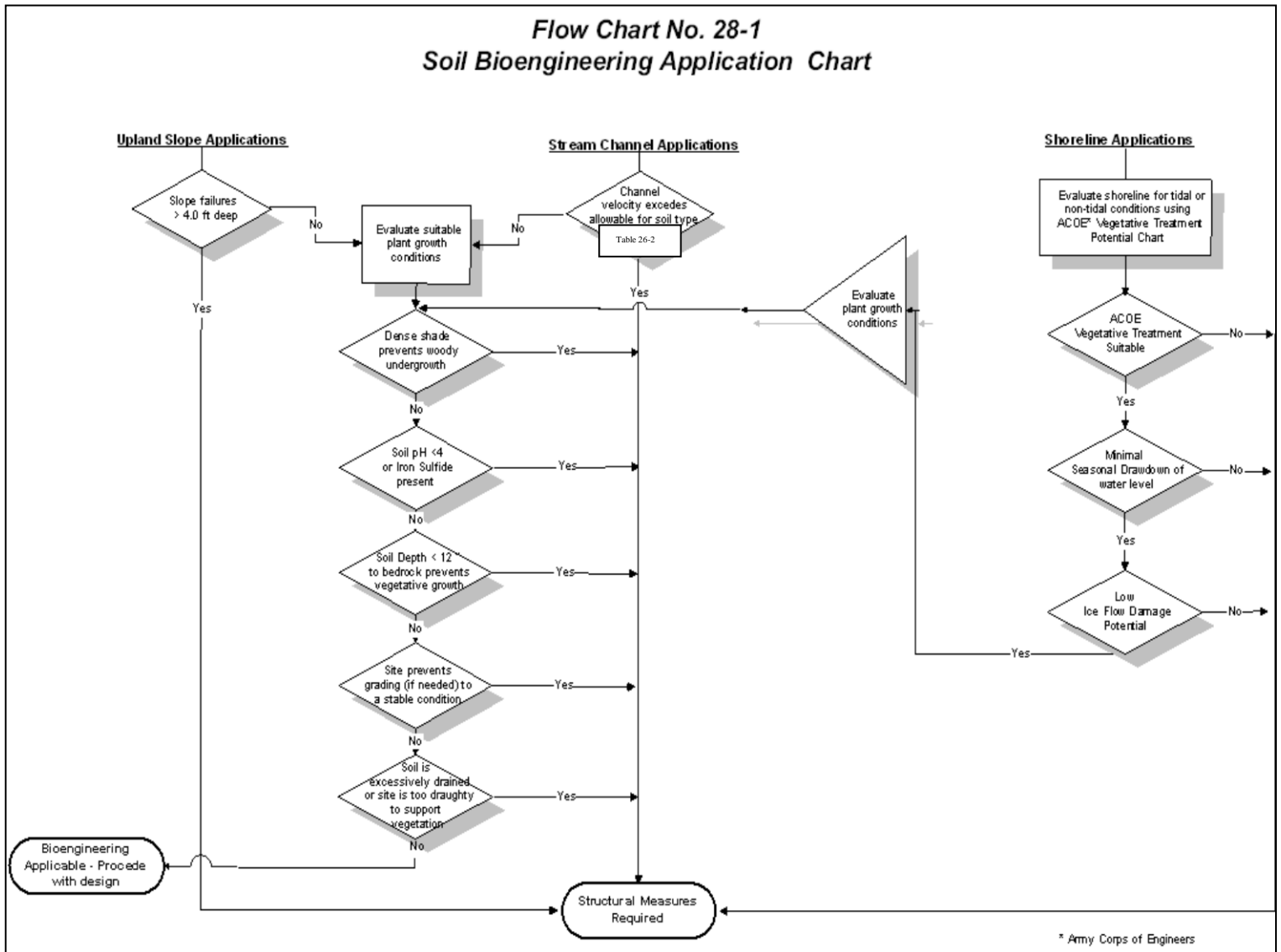
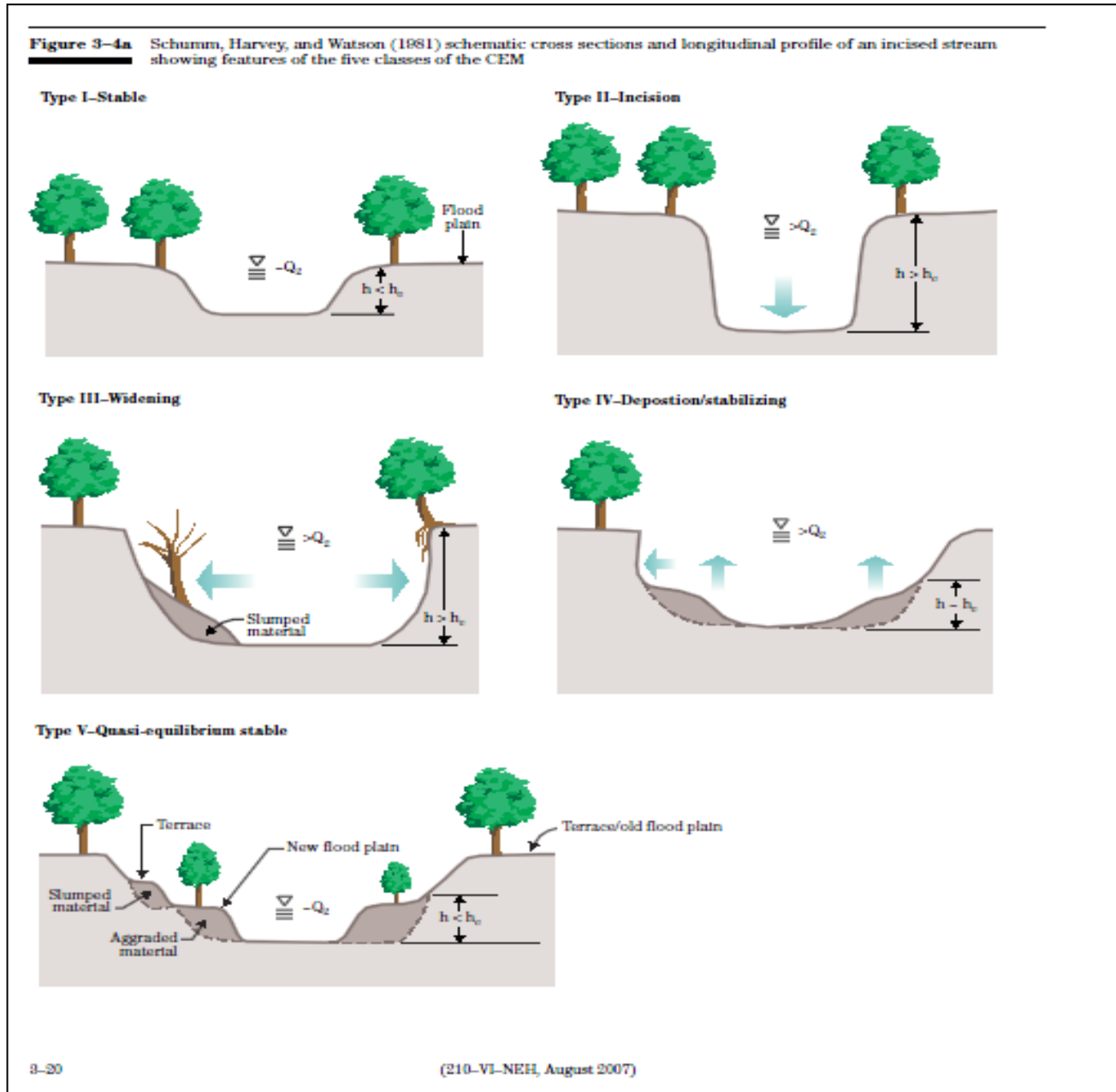

Figure 26-1 – Simplified Channel Evolution Model



2. ENGINEERING

Grading

Steep, unstable slopes and deep undercuts in banks may require extensive grading to achieve a stable slope or will require structural measures, (such as crib walls, riprap, or wire-mesh baskets), or redirective measures within the channel (such as weirs or vanes) . For planting purposes only, the steepest acceptable slope is 1.5 horizontal to 1.0 vertical. Slope stability analysis or design shall be subject to municipal, county and state regulations. All newly graded banks shall be protected from overbank flow in accordance with the Standard for Diversions, pg. 15-1., Grade Stabilization, pg. 17-1 or Slope Protection, pg. 27-1 as appropriate.

Channel Realignment

The realignment of channels (change in location or cross-sectional geometry) shall be kept to an absolute minimum unless realignment is part of an overall stream restoration plan and is the subject of the soil erosion and sediment control plan.

Channel Capacity

Peak discharge and/or hydrographs for capacity shall be determined by the following methods:

1. Rational Method - for peak discharge of uniform drainage areas as outlined in Technical Manual for Land Use Regulation Program, Bureau of Inland and Coastal Regulations Stream Encroachment Permits, Trenton, N.J. September 1997 or subsequent editions
2. NRCS Win TR-55 or Win TR-20
3. U.S. Army Corps of Engineers HEC HMS
4. Other methods which produce similar results to the models listed above.

Hydraulic Requirements

Manning's formula (where appropriate) or a water surface profile analysis shall be used to determine the velocities in the channels. Resistance (Manning's "n") values shall be estimated using Table 26-1. Site specific n values may be used if verified by USGS stream gage data or by a hydrologic and hydraulic analysis approved by the local district.

Design storm requirements for stability analysis shall be in accordance with the Standard for Channel Stabilization, pg. 11-1. Aged condition shall analyze capacity at vegetative maturity.

Table 26-1 - Estimating Manning's "n" for Soil Bioengineering practices

Bioengineering System	Manning's "n" values*	
	Installation condition (stability)	Mature condition (capacity)
Conventional vegetation (use of the retardance method is required for designing grass lining)	0.025	0.055
Live Staking Live Facines (wattling bundles) Branchpacking Brushmattress Live Cribwall (similar to wire-mesh baskets in hydraulic effects)	0.025	0.1
Joint Planting	see riprap standard	see riprap standard

* Does not consider channel alignment, obstructions etc. Based on non-gravel soils. See Appendix 8, supplement "A" for additional guidance for selecting "n" values

Maximum allowable velocities for bankfull and out of bank discharges (fig. 26-2) shall be based on allowable soil velocities found in Table 26-2. These velocities are based on the use of an acceptable erosion control matting in conjunction with the bioengineering system. Every reach shall be individually designed unless all reaches are designed for the worst cases for velocity and capacity (lowest allowable velocity, steepest slope). **Bioengineering designs must begin and end in a stable channel section.** Design procedures may be evaluated according to channel conditions represented in Table 26-3, below.

Table 26-2 - Maximum Allowable Velocities for Bioengineering

Soil Texture	Velocity (fps) with matting ¹
Sand	2
Silt loam, sandy loam, loamy sand, loam and muck	5
Silty clay loam, sandy clay loam	5.5
Clay, clay loam, sandy clay, silty clay	6

- All Soil Bioengineering Application designs shall incorporate a an erosion control blanket or flexible channel liner over seeded areas and shall be integrated into the measure in accordance with USDA EFH Chapters 16 and/or 18. The flexible channel liner shall be selected based on the design requirements for the planned bioengineering application.

Figure 26-2: Terminology in Channel Flow Descriptions

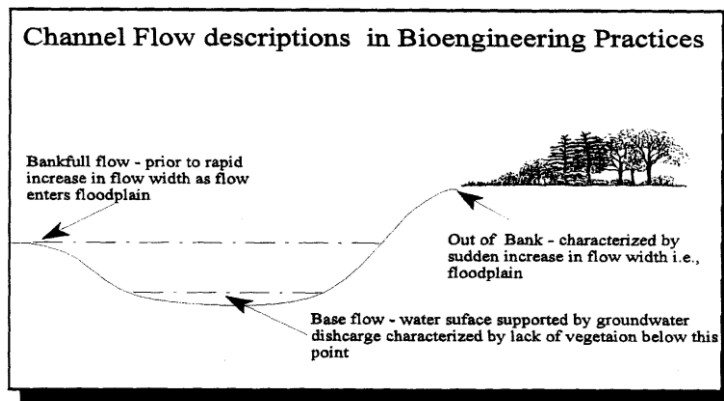
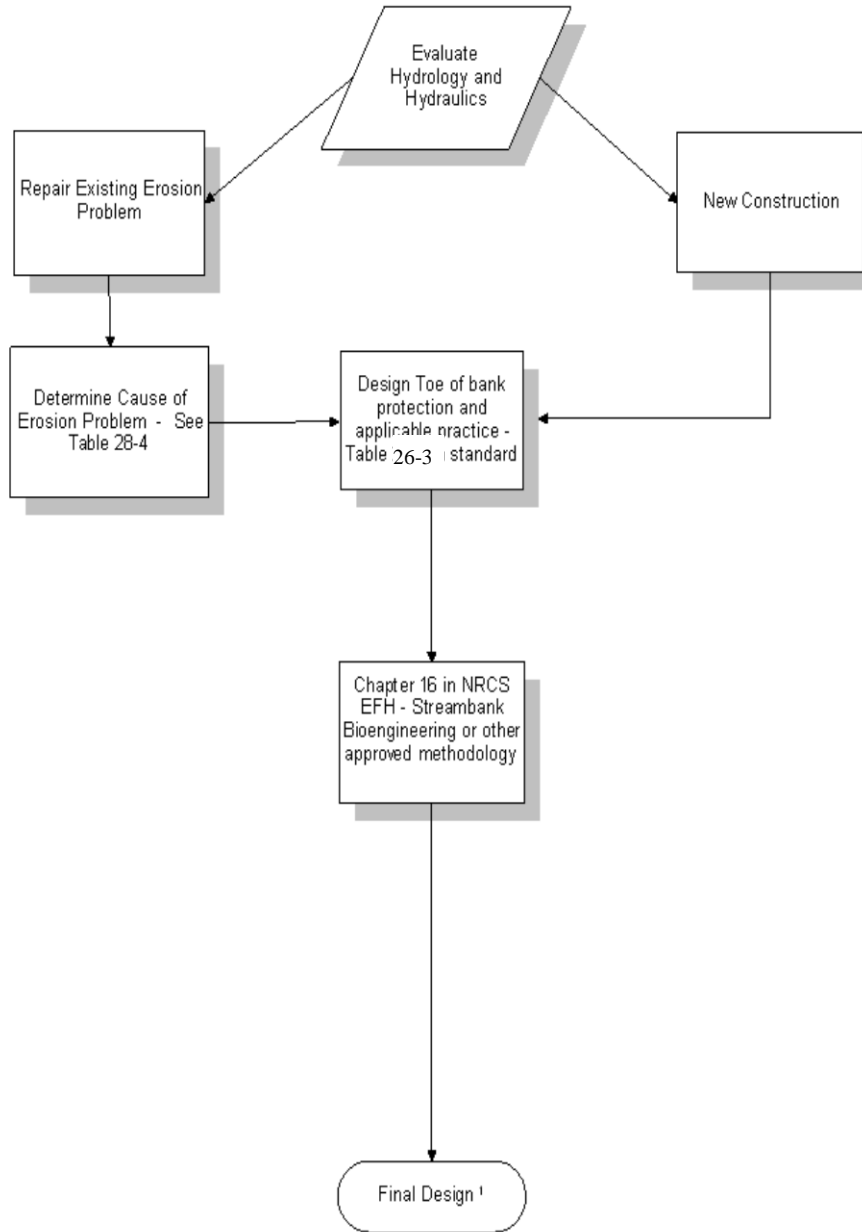

Table 26-3 – Design Approach based on Channel Boundary Conditions

Channel Boundary Condition	Design Consideration Approach
Significant sediment load and moveable channel boundaries	Alluvial channel design techniques
Boundary material smaller than sand size	Allowable Velocity
Boundary material larger than sand size	Allowable shear stress
Boundary material does not act as discrete particles	Tractive Power
No base flow in channel. Climate can support permanent vegetation	Grass lined (retardance) / tractive stress

Toe Protection at Base Flow Elevation - Toe protection is to be provided on all streambank stabilization projects. Methods of providing toe protection may consist of a fiber roll revetment (coir log) adequately anchored or a structural revetment such as rock rip rap. Fiber roll revetments have a design life of 5 years and are suitable for sites where there is a high probability that vegetation, once established, will be adequate for stabilizing the toe zone. In general, this will be in lower velocity channels where adjacent reaches indicate vegetation alone will be adequate. Riprap for toe protection shall be designed using the bankfull or design discharge velocity using procedures in the Standard for Riprap, pg. 22-1

Flow Chart No. 26-2 Soil Bioengineering In-Stream Design Chart



1 - Final design may need to include diversion of overland flows from slopes

Flow Chart No. 26-2 (Soil Bioengineering In-Stream Design Chart) shall be followed for stream channel designs.

Table 26-3 - Summary of Streambank /Upland Slope Bioengineering Protection Measures

System Type	Zone of Application¹ - Base Flow - Base to Top - Out of Bank	Types of erosion problems for which the system is suitable	Comments and Restrictions
Live stake	Base to Top Out of Bank	bank scour, overbank runoff	suitable for small, simple erosion problems when used in conjunction with other systems.
Live fascine	Base to Top, Out of Bank	general bank scour-, overbank runoff	useful for moderate to severe erosion-, should not be used on bank faces longer than 15 ft, after sloping.
Branchpacking	Base to Top, Out of Bank	local bank scour, gullies eroded by overbank runoff	restricted to repair of small sites(maximum depth = 4.0 ft.)
Vegetated Geogrid	All Zones	toe erosion, local bank scour	useful on steep slopes (up to 0.5H: IV) where space is limited/generally restricted to heights not exceeding 6 ft. overall
Live cribwall	All Zones	local bank scour, toe erosion (requires structural toe protection)	
Joint planting	Base to Top, Out of Bank	see riprap standard	see riprap standard
Brushmattress	Base to Top, Out of Bank	local and general bank scour; debris gouging	generally used on 3H: 1V graded slopes restricted to sites of 50 linear feet or less
Conventional vegetation	Base to Top, Out of Bank	general & local bank scour	See Table 26-2 for velocity restrictions
Tree revetment	Base to Top	general bank scour	Provides temporary protection, susceptible to damage by flooding debris and beavers
Riprap (incl. wire-mesh baskets)	All Zones	local & general bank scour, toe erosion	All headcutting and general bed degradation by erosion must have armored protection
Coir (coconut fiber) Logs	Base, Base to Top	toe erosion	Must be 2/3 submerged in water to be an effective rooting medium.

1. See Figure 26-1 for description of zones.

3. VEGETATION

Plant materials will be live, viable woody or herbaceous vegetation. The plant materials will be obtained from commercial sources or in the case of woody cuttings, may be harvested from native stands during the dormant period. (November-April).

Plant Adaptation Zones

Base Flow Zone (Toe Zone) - Too wet to grow vegetation or where side slopes meet channel bottom (intermittent streams). Select vegetation which develops an extensive root system and tolerates extended saturation. This includes Obligate and Facultative Wet herbaceous and woody plants.

Above Base flow to top of bank or 2 year storm elevation (Bank Zone) - Area between level of base flow and top of bank or 2 year storm elevation. Select vegetation which tolerates wetting and drying soils. This includes Facultative and some Facultative Wet grasses, forbs and shrubs.

Out of bank. (Terrace Zone) - Select vegetation which tolerates droughty conditions. This may include some Facultative and most Facultative Upland plants.

A. Plant Material Specifications

- * Rooted seedlings - Plants shall be at least 12" long. The root system shall have approximately the mass equal to the top portion.
- * Unrooted cuttings - Cuttings shall be 8"-12" in length and 1/4" - 1/2" in diameter.
- * Live Stake - cuttings shall be 2.0' to 3.0' in length and 1/2" to 2.0" in diameter
- * Live brush - Live brush will consist of the whole above ground portion of willow, redosier dogwood, or other hardwood species which root easily from cuttings. Plants shall be 4 to 8 feet in height and free of disease. When there is a shortage of live, dormant brush, up to 30% of nonrooting species may be mixed randomly with the rooting species. Brush will be cut by shears or saw, not by ax.
- * Herbaceous plants - Grasses, sedges, and rushes shall be provided in multiple-culmed pots having a minimum of two stems per pot. Stems shall have a minimum length of 6".

B. Plant Selection - See Table 26-5 for specific species adaptations.

1. Herbaceous plant materials to be used in the coir fiber rolls shall consist of a mixture of the following:

Asclepias incarnate - Swamp milkweed
 Acorns calamus/americanus - Sweet Flag
 Calamagrostis spp. - Bluejoint reedgrass
 Carex spp. - Sedges
 Cinna arundinacea - Wood reedgrass
 Distichlis spicata - Seashore saltgrass
 Eupatorium purpureum - Joe-Pye weed
 Glyceria spp. - Mannagrasses
 Iris versicolor - Blueflag iris

Juncus spp. - Rushes
 Lobelia cardinalis - Cardinal flower
 Pontederia cordata - Pickerel Weed
 Sagittaria latifolia - Duckpotato
 Scirpus spp. - Bulrushes
 Sparganium spp. - Burrreed
 Spartina spp. - cattails

2. Woody plants shall consist of bareroot plants or unrooted cuttings and stems (whips) of hardwood shrub species which root easily. The plant materials may come from nursery sources or existing local stands, or a combination of the two. Plant Materials suitable for use as rooted or unrooted cuttings include:

Cephalanthus accidentalis - buttonbush	Salix exigua - sandbar willow
Baccharis halimifolia - groundselbus	Salix discolor - pussy willow
Cornus amomum - silky dogwood	Sambucus canadensis - elderberry
Cornus sericea - redosier dogwood	Viburnum dentatum - southern arrowwood
Salix purpurea - "Streamcol purpleosier willow"	Viburnum lentago - nannyberry
Salix cottetii - "Bankers" dwarf willow	Viburnum prunifolium - blackhaw viburnum

- c. Plant Materials suitable for use only as bareroot or containerized plants include:

Alnus rugosa - speckled alder	Physocarpus opulifolius - ninebark
Alnus serrulata - smooth alder spp.	Prunus pumila var. depressa - dwarf sand cherry
Amorpha fruticosa - indigobush	Rhododendron viscosum - swamp azalea
Aronia arbutifolia - red chokecherry	Rosa palustris - swamp rose
Clethra alnifolia - sweet pepperbush	Spiraea tomentosa - steeplebush
Cornus racemosa - gray dogwood	
Ilex verticillata - winterberry holly	
Lindera benzoin - spicebush	

- d. Supplemental Grass Mixtures

Grass species suitable for stabilizing disturbed areas that are somewhat poorly to poorly drained are:

<u>SPECIES</u>	<u>COMMON NAME</u>	<u>REMARKS¹</u>
Agrostis alba	Redtop	SP,I,CG
Agrostis palustris	Creeping bentgrass	P,I,CG
Andropogon glomeratus	Lowland broom sedge	P,N,WG
Dicanthelium clandestinum	Deertongue	P,N,WG
Echinochloa crusgalli	Japanese millet	A,T,WG
Elymus virginicus	Wild rye	P,N,CG
Lolium perenne ²	Perennial ryegrass	SP,I,CG
Lotus corniculatus ^{3,4}	Birdsfoot trefoil	P,I,CL
Panicum virgatum	Switchgrass	P,N,WG
Poa trivialis	Rough bluegrass	P,I,CG
Trifolium repens ⁴	White/Ladino clover	SP,I,CL

- | | | |
|----|----------------|----------------------------|
| 1. | P - perennial | CG - Cool-season grass |
| | A - annual | WG - warm season grass |
| | I - introduced | CL - Cool-season legume |
| | N - native | SP - Short-lived perennial |

2. Perennial ryegrass may be substituted for redtop in all mixes except Mix # 7.
3. Birdsfoot trefoil is not well adapted to the coastal plain. Use only in northern and central Jersey.
4. Need specific legume inoculant.

Note: Warm-season grass seeding rates are based on Pure Live Seed (PLS)

Suitable seeding mixtures and recommended seeding rates for various site conditions:

Seed Mix 1:

Cool-season mix suitable for shady sites.

- * Redtop 1/lbs./ac.
- * Hard fescue 40 lbs./ac.
- * Rough bluegrass 15 lbs./ac.

Seed Mix 2:

Warm-season mixture suitable for highly acid soils. Provides excellent wildlife value.

- * Blackwell switchgrass 15 lbs./ac. PLS
- * Tioga deertongue 10 lbs./ac. PLS
- * Japanese millet (nurse) 8 lbs./ac. PLS

Seed Mix 3:

All native mixture suitable for somewhat acid soils. Provides good to excellent wildlife value.

- * Blackwell switchgrass and/or 10 lbs./ac. PLS
- * Broomsedge 12 lb&./ac. PLS
- * Tioga deertonque 5 lbs./ac. PLS
- * Wild rye 5 lbs./ac. PLS

Use a nurse crop such as oats or rye.

Seed Mix 4:

Turfgrass mixture suitable for moist, shady areas.

- * Rough bluegrass 25 lbs./ac.
- * Perennial ryegrass 15 lbs./ac.
- * Creeping bentgrass 10 lbs./ac.

Optional:

- *White clover or 5 lbs./ac.
- *Birdsfoot trefoil 8 lbs./ac.

Seed Mix 5:

Mixture for providing quick, semi-permanent cover in areas where natural succession is encouraged. Excellent wildlife value.

- * Redtop 2 lbs./ac.
- * Japanese millet 8 lbs./ac.
- * White/Ladino clover 5 lbs./ac.

Seed Mix 6:

Shotgun mix (for those extremely complex sites)

- *Tioga deertongue 15lbs./ac. PLS
- *Redtop or 3lbs./ac. PLS
- *Perennial ryegrass 5lb./ac. PLS
- *Wild rye 10lbs./ac. PLS
- *Switchgrass 8lbs./ac. PLS
- *Broomsedge 12lbs./ac. PLS

Wildflowers tolerant of wet conditions:

- * *Aquilegia canadensis* - Eastern Columbine
- * *Chrysanthemum leucanthemum* - Ox-eye Daisy
- * *Hesperis 'matronalis* - Dame's Rocket
- * *Lupinus perennis* - Perennial Lupine
- * *Myostis sylvatica* - Forget-Me-Not
- * *Rudbeckia hirta* - (Golden Jubilee) Black-eyed Susan

Table 26-4: Types of Erosion And Causes of Erosion	
Type of Erosion	Causes
Toe erosion and upper bank failure	Removal of unconsolidated or noncohesive lower materials, especially bank failure along outside bends. Widespread toe erosion may be associated with bed lowering.
General bed degradation (Bed scour over extended channelization, reaches)	Changes in stream gradient due to factors such as lowering of stream base level due to lake or tailwater fluctuations, stream or stream relocation. Increased stream discharge due to flow diversion or watershed changes such as urbanization.
Headcutting	In streams undergoing bed degradation, headcuts often develop at locations where more resistant materials outcrop in the stream channel. Headcuts may develop at a stream mouth when base level is lowered suddenly due to dredging, erosion or draining of a lake.
Middle and upper general bank scour	Increased discharge resulting from watershed changes; increased flow velocities caused by reduction in channel roughness or increased gradients; removal or loss of bank vegetation.
Local streambank scour	Scour of local lenses or deposits of unconsolidated material, erosion by secondary currents caused by flow obstructions and channel irregularities, loss of bank vegetation.
Local bed scour	Local bed scour may be caused by channel constrictions, flow obstructions such as debris dams or flow deflectors, or trapping of sediment in reservoirs or sediment traps. Some scour generally occurs below culverts.
Piping	Piping develops when fines are removed by water flowing laterally under the surface. Extensive pipe development requires 1) rapid infiltration, 2) steep hydraulic gradients, and 3) <i>zones of concentrated flow</i> . Piping may occur in stratified soils where vertical movement is restricted by sudden reduction in hydraulic conductivity between strata or where poorly compacted soil around buried pipes provides conduits for water movement.
Overbank runoff	Failure to provide adequate means of directing concentrated flows from overbank areas into the channel.

Table 26-5: Shrubs suitable for Soil Bioengineering Systems

Species	Habitat ¹	Bank Zone ²	Root Form ³	Shade ⁴ Tolerance	Flood ⁵ Tolerance	pH range ⁶	Comments
<i>Alnus serrulata</i> Smooth alder	nontidal	toe	rooted	medium	regular	5.5-7.5	Nitrogen fixer weak wooded
<i>Amorpha fruticosa</i> False indigo	tidal fresh moist woods	lower-mid	rooted	low	seasonal	6.0-8.5	Req. full sun Drought tolerant
<i>Aronia arbutifolia</i> Red chokeberry	nontidal	lower-mid	rooted	medium	irregular seasonal	5.1-6.5	Drought tolerant
<i>Aronia melanocarpa</i> Black chokeberry	nontidal	mid-upper	rooted	low	irregular seasonal	5.1-6.5	Drought tolerant
<i>Baccharis halimifolia</i> Groundsel bush	tidal tidal fresh	mid-upper	rooted, unrooted	high	seasonal	7.0-8.5	M/F separate plants
<i>Cephalanthus occidentalis</i> Buttonbush	nontidal tidal fresh	toe	rooted unrooted	high	permanent	6.1-8.5	Tolerates brief drought
<i>Celthra alnifolia</i> Sweet pepperbush	tidal nontidal	mid-upper	rooted	high	seasonal	4.5-6.5	
<i>Cornus amomum</i> Silky dogwood	streambankspond edges	lower-mid	rooted unrooted	medium	seasonal	5.5-8.5	Drought tolerant
<i>Cornus racemosa</i> Gray dogwood	streambanks pond edges	lower-mid	rooted unrooted	high	seasonal	5.5-8.5	Drought tolerant
<i>Cornus sericea</i> Redosier dogwood	streambanks pond edges	toe-mid	rooted unrooted	medium	seasonal	5.5-8.5	Drought tolerant
<i>Ilex decidua</i> Possumhaw	forested wetlands pond edges	lower-mid	rooted unrooted	high	irregular	4.0-6.0	M/F separate plants
<i>Ilex glabra</i> Inkberry	forested wetlands sandy woods	mid-upper	rooted	high	irregular inundation	4.5-6.0	M/F separate plants. Resists salt spray
<i>Ilex verticillata</i> Winterberry holly	tidal fresh forested wetland	lower-mid	rooted	high	seasonal	4.5-8.0	Drought tolerant
<i>Itea virginica</i> Virginia sweetspire	forested wetland streambanks	toe	rooted	high	regular	5.0-7.0	Tolerates some salt
<i>Iva frutescens</i> Hightide bush	tidal brackish	lower	rooted	low	regular	6.0-7.5	Tolerates 15ppt salt
<i>Leucothe racemosa</i> Leucothe	forested wetland moist woods	lower mid	rooted	high	regular	5.0-6.0	Tolerates some dry-down
<i>Lindera benzoin</i> Spicebush	seasonal wetlands floodplain	lower-mid	rooted	high	seasonal	4.5-6.5	Tolerates some drought

Table 26-5: Shrubs suitable for Soil Bioengineering Systems

Species	Habitat ¹	Bank Zone ²	Root Form ³	Shade ⁴ Tolerance	Flood ⁵ Tolerance	pH range ⁶	Comments
<i>Lyonia ligustrina</i> Maleberry	open woods	lower-mid	rooted	low	seasonal	4.0-6.0	Acid tolerant
<i>Magnolia virginiana</i> Sweetbay magnolia	stream borders forested wetlands	lower-mid	rooted	high	irregular/ seasonal	4.0-6.5	Tolerates infreq. flooding by salt
<i>Myrica cerifera</i> Wax myrtle	tidal fresh brackish swales	mid-upper	rooted	high	regular	4.0-6.0	tolerates 10 ppt salt. N-fixing
<i>Myrica pennsylvanica</i> Bayberry	tidal fresh brackish nontidal	mid-upper	rooted	high	irregular-seasonal	5.0-6.5	Tolerates drought. N-fixer
<i>Physocarpus opulifolius</i> Ninebark	streamsides wood edges	low-mid	rooted	medium	seasonal		
<i>Prunus pumila</i> var. <i>depressa</i> Dwarf sand cherry	streamsides sandbars	mid-upper	rooted	low	irregular	6.5-8.5	Native to Del. River. Groundcover
<i>Rhododendron viscosum</i> Swamp azalea	forested wetlands	toe-low	rooted	medium	seasonal-regular	4.0-6.0	susceptible to disease
<i>Rosa palustris</i> Swamp rose	tidal fresh forested wetland streambank	toe-low	rooted	low	seasonal-regular		
<i>Rhus typhina</i> / <i>glabra</i> Staghorn/Smooth sumac	disturbed banks/dry sites	upper	rooted	low	irregular	6.1-7.0	tolerates some drought
<i>Salix X cottetii</i> 'Bankers' Dwarf willow	streambank	toe-mid	unrooted rooted	medium	regular-permanent		introduced male hybrid. noninvasive
<i>Salix discolor</i> Pussy willow	streambank forested wetland	toe-mid	unrooted rooted	medium	regular-permanent	6.6-7.5	
<i>Salix exigua</i> Sandbar willow	streambank sandbars	toe	unrooted rooted	low	regular-permanent		
<i>Salix purpurea</i> 'Streamco' purpleosier willow	streambank	toe-upper	unrooted rooted	medium	regular-permanent	6.0-7.0	introduced noninvasive shrub
<i>Sambucus canadensis</i> Elderberry	tidal fresh nontidal wet meadow	low-mid	rooted- unrooted	high	irregular-seasonal	6.0-8.0	some salt tolerance tolerates drought
<i>Spirea alba</i> / <i>tomentosa</i> Meadowsweet	forested wetland	mid-upper	rooted	low	irregular	5.1-6.0	
<i>Viburnum dentatum</i> Southern arrowwood	tidal fresh nontidal forested wetland	mid-upper	rooted unrooted	medium	seasonal	5.1-7.0	tolerates drought

Table 26-5: Shrubs suitable for Soil Bioengineering Systems

Species	Habitat ¹	Bank Zone ²	Root Form ³	Shade ⁴ Tolerance	Flood ⁵ Tolerance	pH range ⁶	Comments
Viburnum lentago Nannyberry	forested wetland	mid-upper	rooted unrooted	medium	seasonal		
Viburnum prunifolium Blackhaw viburnum	forested wetland	upper	rooted unrooted	medium	irregular	6.5-7.0	
Viburnum trilobum Am. cranberrybush	forested wetlands	lower-mid	rooted unrooted	low	irregular- seasonal	6.0-7.5	tolerates drought

Footnotes:

1. Habitat:
Native habitat of the plant.
2. Bank zone:
toe - elevation of baseflow
lower to mid - from base to two year flood elevation
upper - above two year elevation to flood plain
3. Root form:
rooted - use bare-root plants
unrooted - use dormant cuttings/brush
4. Shade Tolerance:
low -requires full sun
medium - tolerates partial shade and full sun
high - tolerates full shade and full sun
5. Flood tolerance:
permanent - tolerates inundation or saturation 76-100% of the growing season.
regular - tolerates inundation or saturation 26-75% of growing season.
seasonal - tolerates inundation or saturation 13-25% of the growing season.
irregular - tolerates inundation or saturation 5-12% of the growing season.
6. pH range:
Preferred range for successful plant establishment.

Table 26-6: Soil Bioengineering Vegetative Treatment Potential (VTP) for Ponds and Lake Shores

Shoreline Variables	Directions For Use: Enter the applicable VTP rating (bold number) in the last column. Add the total of the VTP ratings and compare with the Treatment Potential (TP) scale below					VTP
1. Fetch: Average distance in miles of open water measured perpendicular to the shore and 45 degrees either side of perpendicular to shore.	Less than 0.5 miles 8	0.5 to 1.4 miles 7	1.5 to 3.4 miles 4	3.5 to 4.9 miles 2	over 5.0 miles 0	
2. General shape of shoreline for distance of 200 yards on each side of planting site.	Coves 8	Irregular shoreline 3		Headland or straight shoreline 0		
3. Shoreline orientation: General geographic direction the shoreline faces.	Any less than ½ mile fetch 5	West to North 3	South to West 2	South to East 1	North to East 0	
4. Boat traffic: Proximity of site to recreational and commercial boat traffic.	None 5	1-10 per week within ½ mile of shore 3	More than 10 per week within ½ mile of shore 2	1-10 per week within 100 yards of shore. 1	More than 10 per week within 100 yards of shore. 0	

_____ Cumulation of VTP for variables 1,2,3, and 4

Treatment Potential (TP) Scale : if TP is:

<u>Between</u>	<u>And</u>	<u>Potential of site to be successfully stabilized with soil bioengineering</u>
23	26	Excellent
20	22	Very Good
16	19	Good
13	15	Fair
below 13		Poor

Shoreline Stabilization

The Vegetative Treatment Potential (VTP) as shown in Table 26-6 shall be evaluated for all shoreline protection measures. Bioengineering treatments involving vegetation may only be considered where the Treatment Potential Scale indicates excellent to very good site conditions. Vegetative measures alone are not suited to sites where wave heights are greater than 1.5 feet and beach slopes are steeper than 12H to 1V. Fiber roll revetments or structural stabilization measures such as rock riprap, and off-shore wave dissipater berms shall be considered for use in combination with vegetation where site conditions are not suited to vegetation alone. Fiber roll revetments have a design life of 5 years and are suitable for sites where there is a high probability that vegetation, once established, will be adequate for stabilizing the shoreline. In general, this will be in lower energy situations where adjacent reaches indicate vegetation alone will be adequate. Riprap for shoreline stabilization shall be designed using procedures in the Standard for Riprap, pg. 22-1.

**STANDARD
FOR
STABILIZED CONSTRUCTION ACCESS**

Definition

A stabilized pad of clean crushed stone located at points where traffic will be accessing a construction site.

Purpose

The purpose of a stabilized construction access is to reduce the tracking or flowing of sediment onto paved roadways (or other impervious surfaces).

Conditions Where Practice Applies

A stabilized construction exit applies to points of construction ingress and egress where sediment may be tracked, or flow off, the construction site.

Water Quality Enhancement

In addition to minimizing sediments which can be tracked directly onto pavement during construction, oils, greases and diesel fuels which become mixed with sediment during construction may also migrate into the offsite drainage system where they may enter directly into a waterway. By preventing or minimizing the tracking of sediments onto paved areas, a significant reduction in construction related hydrocarbon pollution will also be controlled.

Design Criteria

Stone Size - Use ASTM C-33, size No. 2 (2 ½ to 1 ½ in) or 3 (2 to 1 in). Use clean crushed angular stone. Crushed concrete of similar size may be substituted but will require more frequent upgrading and maintenance.

Thickness - not less than six (6) inches.

Width - not less than full width of points of ingress or egress.

Length - 50 feet minimum where the soils are coarse grained (sands or gravels) or 100 feet minimum where soils are fine grained (clays or silts), except where the traveled length is less than 50 or 100 feet respectively. These lengths may be increased where field conditions dictate. Stormwater from up-slope areas shall be diverted away from the stabilized pad (see Standard for Diversions, pg. 15-1). Where diversion is not possible, the length of the stabilized pad shall be as shown in Table 27-1. Where the slope of the access road exceeds 5%, a stabilized base of Hot Mix Asphalt Base Course, Mix I-2 shall be installed. The type and thickness of the base course and use of a dense graded aggregate sub-base shall be as prescribed by local municipal ordinance or other governing authority.

At poorly drained locations, subsurface drainage gravel filter or geotextile shall be installed before installing the stabilized construction entrance.

Table 27-1: Lengths of Construction Exits on Sloping Roadbeds

Percent Slope of Roadway	Length of Stone Required	
	Coarse Grained Soils	Fine Grained Soils
0 to 2%	50 ft	100 ft
2 to 5%	100 ft	200 ft
>5%	Entire surface stabilized with Hot Mix Asphalt Base Course, Mix I-2 ¹	

1. As prescribed by local ordinance or other governing authority.

Where a stabilized construction exit traverses between two buildings, it shall be stoned the entire length of the right-of-way. Mountable stone berms placed across the width of the exit may also be required at the transition point between paved and non-paved areas to trap sediments which are carried by stormwater flowing along the curbline.

Individual lot entrance and egress- After interior roadways are paved, individual lot ingress/egress points may require a stabilized construction entrance consisting of no. 3 stone (1" to 2") to prevent or minimize tracking of sediments. Width of the stone ingress/egress shall be equal to lot entrance width and shall be a minimum of ten feet in length.

Tire washing - If space is limited, vehicle tires may be washed with clean water before entering a paved area. A wash station must be located such that wash water will not flow onto paved roadways or into unprotected storm drainage systems.

When the construction access exits onto a major roadway, a paved transition area may be installed between the major roadway and the stoned entrance to prevent loose stones from being transported out onto the roadway by heavy equipment entering or leaving the site.

Maintenance

The entrance shall be maintained in a condition which will prevent tracking or flowing of sediment onto roadways. This may require periodic top dressing with additional stone or additional length as conditions demand and repair and/or cleanout of any measures used to trap sediment. All sediment spilled, dropped, washed, or tracked onto roadways (public or private) or other impervious surfaces must be removed immediately.

Where accumulation of dust/sediment is inadequately cleaned or removed by conventional methods, a power broom or street sweeper will be required to clean paved or impervious surfaces. All other access points which are not stabilized shall be blocked off.

Figure 27-1: Stabilized Construction Access

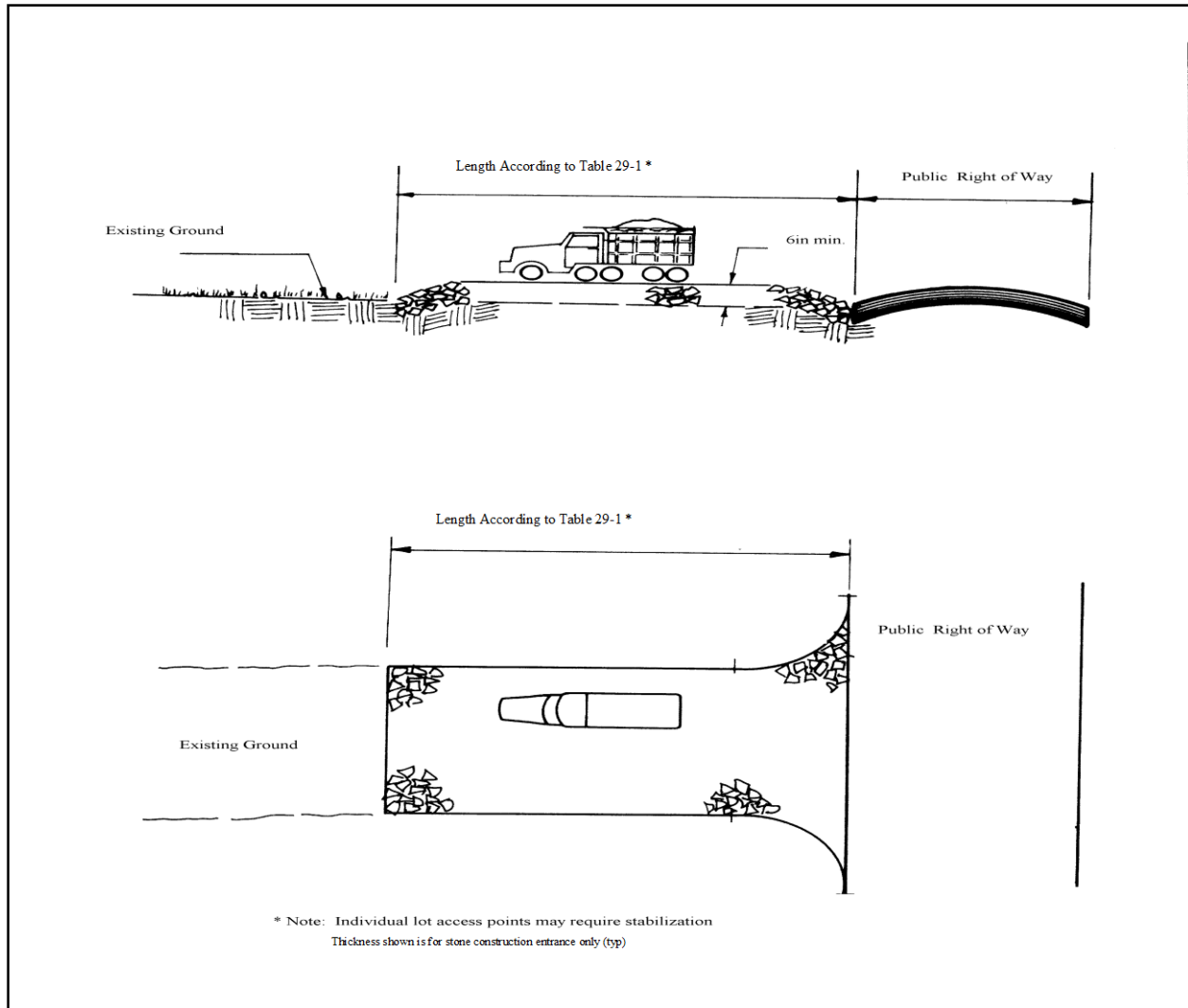

**STANDARD
FOR
STORM SEWER INLET PROTECTION**

Definition

A temporary barrier and settling facility installed at a storm sewer inlet.

Purpose

The purpose of storm sewer inlet protection is to intercept and retain sediment, thus preventing the entrance of sediment into the storm sewer system.

Conditions Where Practice Applies

1. Contributing drainage area is 3 acres or less.
2. A storm sewer or the outlet channel of a storm sewer needs protection from sediment.
3. Traffic will not destroy or cause constant maintenance of the storm sewer inlet protection.
4. A traffic hazard will not be created.
5. A flooding problem will not be created.

Water Quality Enhancement

The primary benefit to water quality is the removal of sediment from stormwater runoff prior to entering the stormsewer system. As an added benefit, other floatable debris, such as vegetative matter and litter may also be filtered out of the runoff.

Design Criteria

The following applies to all methods of storm sewer inlet protection:

1. Must slow the storm water, provide the coarse sediment particles a chance to settle, and provide an area to retain the particles that have settled.
2. In all cases, inlet protection should not completely close off the inlet. Provision must be made to allow stormwater to overflow or bypass filter
3. The protection device will be designed to capture or filter runoff from the 1 year, 24 hour storm event and shall safely convey higher flows directly into the storm sewer system.

Other methods that accomplish the purpose of storm sewer inlet protection may be used if approved by the Soil Conservation District.

Inspections shall be frequent. Maintenance, repair, and replacement shall be made promptly, as needed. The barrier shall be removed when the area draining toward the inlet has been stabilized.

**STANDARD
FOR
STREAM CROSSING**

Definition

A structural span installed across a watercourse to provide a travel way for vehicles or pedestrians. Temporary structures will be in place for no more than one year and shall be removed prior to completion of construction.

Purpose

A stream crossing is designed to provide access across a watercourse while reducing sediment delivery into the stream, minimizing damages to the streambed or channel, and avoiding flood damages.

Condition Where Practice Applies

This standard applies to temporary and permanent stream crossings. The temporary stream crossing shall be used to cross streams with drainage areas less than one square mile. Structures which must handle flow from larger drainage areas should be designed as permanent structures using generally accepted engineering practice. Complex sites requiring bridge scour studies are beyond the scope of this standard.

Water Quality Enhancement

Flow restrictions caused by stream crossings can increase velocity through the structure causing stream bed erosion and scour. Reducing flow velocity or protecting the stream bed can minimize erosion and sediment production. Crossings can minimize or prevent oils, greases and diesel fuels which become mixed with sediment during construction and after or which could wash off vehicles, from entering the watercourse. In addition, temporary crossings help to minimizing sediments which can be tracked into the stream during construction.

I. Temporary Crossings

Planning

Temporary stream crossings are necessary to prevent construction vehicles from damaging streambanks and tracking sediment and other pollutants into the watercourse. These structures are, however, undesirable in that they represent a channel restriction which can increase flooding upstream or washout during periods of high flow. Therefore, the temporary nature of the structure is stressed. The structure should be planned to be in service for the shortest practical period of time and to be removed as soon as their function has been completed.

This standard pertains primarily to flow capacity and resistance to washout of the structure. From a safety and utility standpoint, the designer must also be sure that the span is capable of withstanding the expected loadings from heavy construction equipment.

The preferred method for temporarily crossing a stream is a bridge made of wood, metal or other material which can provide access across the stream. A bridge causes the least amount of disturbance to the stream bed and banks. They can also be quickly removed and reused. In addition, temporary bridges pose the least chance for interference with fish passage and migration. The other method of temporarily crossing a stream is a culvert crossing consisting of stone and a section(s) of pipe. Temporary culverts are used where the channel is too wide for normal bridge construction or the anticipated loading of construction vehicles may prove unsafe for single span bridges. There is some disturbance to the stream bed and banks during construction and removal of the temporary culvert crossing. The stone, along with the temporary culverts, can be salvaged and reused.

Design Criteria

1. Temporary Bridge

- a. Structures may be designed in various configurations and out of various materials. However, the bridge must be able to withstand the anticipated loading of the construction traffic. An example of a typical bridge crossing is shown in figure 29-1.
- b. Crossing Alignment - The temporary stream crossing shall be at right angles to the stream. Where approach conditions dictate, the crossing may vary 15 degrees from a line drawn perpendicular to the center line of the stream at the intended crossing location.
- c. The centerline of the roadway approaches on both sides of the crossing shall coincide with the crossing alignment centerline for a minimum of 50 feet from each bank of the stream crossed. If physical right-of-way restraints preclude the 50 feet minimum, a shorter distance may be provided.
- d. A water diversion such as a dike or swale shall be constructed (across the roadway on both roadway approaches) 50 feet (maximum) on either side of the stream crossing. This will prevent roadway surface runoff from directly entering the stream. The 50 feet is measured from the top of the stream bank. If the roadway approach is constructed with a reverse grade away from the stream, a diverting structure is not required. See the Standard for Diversions, pg. 15-1, for roadbed diversions.
- e. Perimeter soil erosion controls, such as a silt fence, must be employed, when necessary, along and parallel to the banks of stream.
- f. All crossings shall have one traffic lane. The minimum width shall be 12 feet.

2. Temporary Culvert

- a. Where culverts are installed, Use ASTM C-33, size No. 2 (2 ½ to 1 ½ in) Coarse Aggregate or larger will be used to form the crossing. The depth of stone cover over the culvert shall be a minimum of 12 inches or as recommended by the pipe manufacturer for the design loading. Rip-rap shall be used to protect the sides of the stone from erosion. Typical culvert details are presented in figure 31-2.
- b. As a minimum, the culvert shall be designed to pass the flow from a 2-year frequency, 24 hour duration storm without overtopping. In addition the culvert shall be designed to ensure that no erosion will result from the 10-year peak storm.
- c. Multiple culverts may be used in place of one large culvert if they have the equivalent capacity of the larger one. The minimum-sized culvert that may be used is 18 inches.
- d. All culverts shall be strong enough to support their cross-sectioned area under maximum expected loads.
- e. The length of the culvert shall be adequate to extend the full width of the crossing, including side slopes.
- f. The slope of the culvert shall be at least 0.25 inch per foot.
- g. Crossing Alignment - The temporary culvert crossing shall be at right angles to the stream. Where approach conditions dictate, the crossing may vary 15° from a line drawn perpendicular to the center line of the stream at the intended crossing location.

- h. The centerline of the roadway approaches on both sides of the crossing shall coincide with the crossing alignment centerline for a minimum of 50 feet from each bank of the stream crossed. If physical right-of-way restraints preclude the 50 feet minimum, a shorter distance may be provided.
- i. The approaches to the structure shall consist of stone pads meeting the following specifications:
 - Stone: ASTM C-33, size No. 2 (2 ½ to 1 ½ in)
 - Minimum thickness: 6 inches
 - Minimum Width: equal to the width of the structure
- j. A water diverting structure such as a dike or swale shall be constructed (across the roadway on both roadway approaches) 50 feet (maximum) on either side of the stream crossing. This will prevent roadway surface runoff from directly entering the stream. The 50 feet is measured from the top of the stream bank. If the roadway approach is constructed with a reverse grade away from the stream, a diverting structure is not required. See the Standard for Diversions, pg. 5-1 for roadbed diversions.

Construction Specifications

1. Temporary Bridge

- a. Clearing and excavation of the stream bed and banks shall be kept to a minimum.
- b. The temporary bridge structure shall be constructed at or above bank elevation to prevent the entrapment of floating materials and debris.

Abutments shall be placed parallel to and on stable banks.

- c. Bridges shall be constructed to span the entire channel. If the channel width exceeds 8 feet (as measured from top-of-bank to top-of-bank), then a footing, pier or bridge support may be constructed within the waterway. One additional footing, pier or bridge support will be permitted for each additional 8-foot width of the channel. No footing, pier or bridge support, however, will be permitted within the channel for waterways which are less than 8 feet wide.
- d. Stringers shall either be logs, sawn timber, prestressed concrete beams, metal beams, or other approved materials.
- e. Decking materials shall be of sufficient strength to support the anticipated load. All decking members shall be placed perpendicular to the stringers, butted tightly, and securely fastened to the stringers. Decking materials must be butted tightly to prevent any soil material tracked onto the bridge from falling into the waterway below.

- f. Run planking (optional) shall be securely fastened to the length of the span. One run plank shall be provided for each track of the equipment wheels. Although run planks are optional, they may be necessary to properly distribute loads.
- g. Curbs or fenders may be installed along the outer sides of the deck. Curbs or fenders are an option which will provide additional safety.
- h. Bridges shall be securely anchored at only one end using steel cable or chain. Anchoring at only one end will prevent channel obstruction in the event that floodwaters float the bridge. Acceptable anchors are large trees, large boulders, or driven steel anchors. Anchoring shall be sufficient to prevent the bridge from floating downstream and possibly causing an obstruction to the flow.
- i. All areas disturbed during installation shall be stabilized within 7 calendar days of that disturbance.
- j. When the temporary bridge is no longer needed, all structures including abutments and other bridging materials should be removed immediately.
- k. Final clean-up shall consist of removal of the temporary bridge from the waterway, protection of banks from erosion, and removal of all construction materials. All removed materials shall be stored outside flood plain of the stream. Removal of the bridge and clean-up of the area shall be accomplished without construction equipment working in the waterway channel.

2. Temporary Culvert

- a. Clearing and excavation of the stream bed and banks shall be kept to a minimum.
- b. The invert elevation of the culvert shall be installed on the natural streambed grade to minimize interference with fish migration. In addition, no construction or removal of a temporary access culvert will be permitted during the following periods critical to spawning along such waters as identified in the Department of Environmental Protection's report entitled "Classification of New Jersey Waters as related to Their Suitability for Trout":

check updated trout production dates.

- i. Brook Trout/Brown Trout Production Watercourses: September 15 through March 15 inclusive
- ii. Rainbow Trout Production Watercourses: February 1 through April 30, inclusive
- iii. Trout Production Watercourses: September 15 through March 15 inclusive
- iv. Trout Stocked Watercourses, or within one mile upstream of Trout Stocked Watercourses and Trout Maintenance Watercourses: March 15 through June 15 inclusive.

Waivers of the timing restrictions may be granted if approved, in writing, by the Department of Environmental Protection's Division of Fish Game and Wildlife.

- c. Filter cloth shall be placed on the streambed and streambanks prior to placement of the pipe culvert(s) and aggregate. The filter cloth shall cover the streambed and extend a minimum of six inches and a maximum of one foot beyond the end of the culvert and bedding material. Filter cloth reduces settlement and improves crossing stability. This requirement should not be confused with the installation of conduit outlet protection (item f. below).
- d. The culvert(s) shall extend a minimum of one foot beyond the upstream and downstream toe of the aggregate placed around the culvert. In no case shall the culvert exceed 40 feet in length.
- e. The culvert(s) shall be covered with a minimum of one foot of aggregate. If multiple culverts are used, they shall be separated by at least 12 inches of compacted aggregate fill. At a minimum, the bedding and fill material used in the construction of the temporary access culvert crossings shall conform with the aggregate requirements cited in part "i" under "Temporary Culvert Crossing."
- f. The Standard for Conduit Outlet Protection (pg. 12-1) shall be addressed for the temporary culvert. The 10 year design storm peak flow shall be used for apron and stone sizing.
- g. When the crossing has served its purpose, all structures including culverts, bedding and filter cloth materials shall be removed. Removal of the structure and clean-up of the area shall be accomplished without construction equipment working in the waterway channel.
- h. Upon removal of the structure, the stream shall immediately be shaped to its original cross-section and properly stabilized. Restoration may include the application of Soil Bioengineering techniques where applicable. See the standard for Soil Bioengineering, pg. 26-1.

II. Permanent Crossings

Planning

This standard pertains primarily to flow capacity and resistance to washout of the structure. Planning, alignment, structural design and other considerations shall be in conformance with the appropriate municipal, county, state or federal requirements and regulations.

Where a natural stream bed is to be provided through the structure to benefit aquatic species, consideration shall be given to flow velocity and potential for bed erosion and scour. Where velocity exceeds the threshold for a stable condition, the need for lining of the stream bed, or use of conduits or box culverts, shall be evaluated.

Design

1. Permanent Culvert

- a. Design criteria shall be as prescribed by the appropriate authority.
- b. For natural stream bed designs:

Three (3) areas of concern should be must be considered for natural stream bed or three (3) sided “bottomless culvert” designs:

- 1. The corners and abutments of the Inlet section of the culvert
- 2. The barrel section of the culvert
- 3. The outlet or discharge section of the culvert

The Corners and Abutments of the Inlet Section of the Culvert:

Designs should avoid significant reductions in flow width transition from the approach channel to the inlet of the structure, which could cause abutment or contraction scour at the inlet. When it is determined that the potential for abutment or contraction scour exists at the inlet, the areas of concern shall be provided with a structural lining, such as riprap. See the Standard for Riprap and the Standard for Channel Stabilization.

The Barrel Section of the Culvert:

The potential for erosion through the structure shall be evaluated by comparing expected flow velocity against the allowable velocity for the soil texture found in the stream bed, see Standard for Channel Stabilization.

When the allowable velocity is exceeded, use of a channel lining, designed to withstand the expected velocity shall be incorporated, or the use of a conduit or box culvert, shall be considered.

Designs shall avoid abrupt changes in the flow profile through the barrel section of the culvert, which would cause a transition in the water surface profile from Super-Critical Flow to Sub-Critical Flow, creating a Hydraulic Jump.

The Outlet Section or the Discharge end of the Culvert:

If the structure causes a reduction in the design flow top width within the channel, and the outlet velocity exceeds the allowable velocity for the soil the culvert is discharging onto, as referenced in Table 12-1, the discharge end of the structure shall meet the Standard for Conduit Outlet Protection.

The utmost consideration shall be give to the protection of the structure.

Transition area riprap for areas disturbed adjacent to the culvert may be required as referenced within the Standard for Conduit Outlet Protection.

Measures to protect intrusion into the areas of the natural stream bed that are proposed to remain undisturbed, during construction shall be provided.

Construction Specifications

Permanent Crossings

Construction specifications for permanent crossings shall be as prescribed by the appropriate authority and shall be in compliance with all federal, state, and local regulations. All applicable standards, such as permanent vegetation, sediment barriers, land grading etc. shall be addressed when designing permanent crossings.

Maintenance

Temporary and permanent installations shall be inspected after every rainfall and at least once a week, whether it has rained or not, and all damages repaired immediately.

1Figure 29-1: Stream Crossing - Temporary Bridge

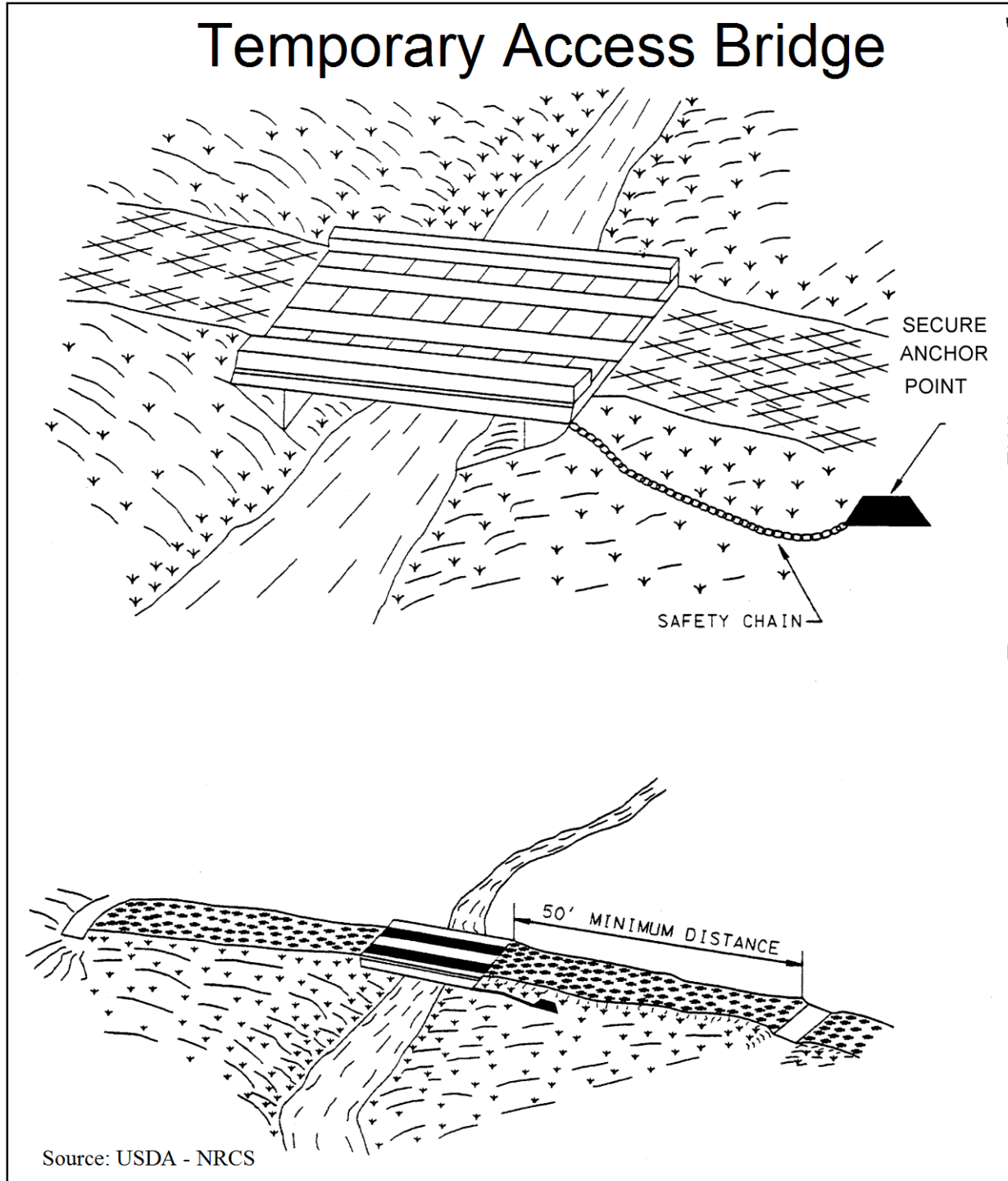

2Figure 29-2: Stream Crossing - Culvert Installation

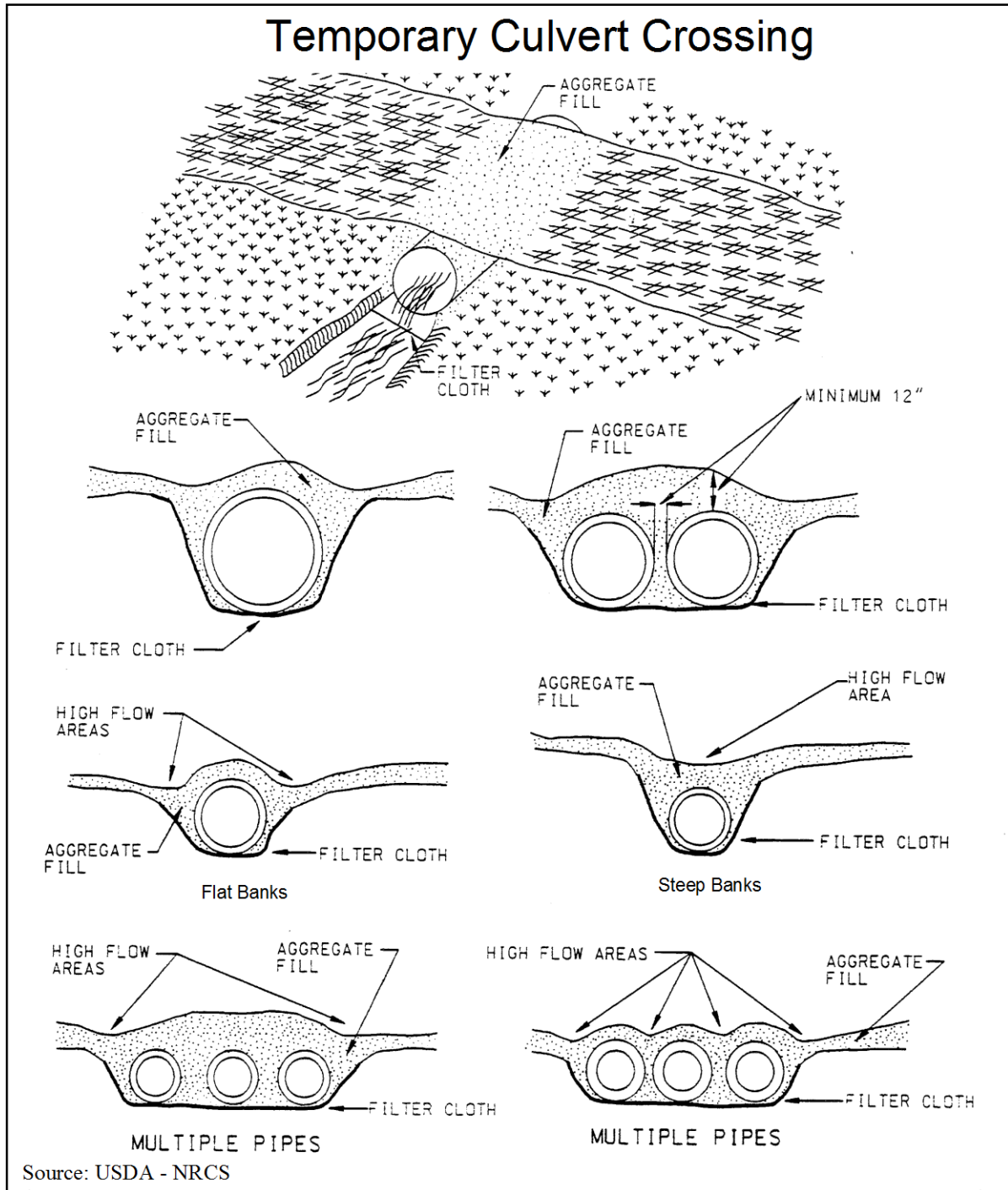

**STANDARD
FOR
SUBSURFACE DRAINAGE**

Definition

Removal of water through the soil by conduit, such as tile, pipe, or tubing, installed beneath the ground surface to collect and convey drainage water.

Purpose

A drain may serve one or more of the following purposes:

1. Improve vegetation by lowering the water table.
2. Intercept and prevent water movement into a potentially wet area.
3. Relieve artesian pressures.
4. Reduce surface runoff.
5. Serve as an outlet for other drains.
6. Replace natural subsurface drainage patterns which are interrupted by construction operations.

Conditions Where Practice Applies

Drains are used in areas having a high water table where benefits of lowering groundwater or controlling surface runoff justify the installation of such a system.

The soil shall have enough depth and permeability to permit installation of an effective system. On-site investigations are required.

An outlet for the drainage system shall be available, either by gravity flow or by pumping. The outlet shall be adequate for the quantity and quality of effluent to be disposed of with consideration of possible damages above or below the point of discharge.

Water Quality Enhancement

The use of subsurface drainage will prevent surface ponding of runoff, which can kill stabilizing vegetation. Loss of this vegetation can result in increased erosion and an increase in discharge of nutrients and fertilizers without the aid of filtration and adsorption from vegetative cover.

Design Criteria

The design and installation shall be based on adequate surveys and investigations.

Design Inflow

The design inflow can be determined by the use of the method described in reference (9), the use of Table 30-1, or by other accepted methods.

TABLE 30-1
INFLOW RATES FROM DIFFERENT SOIL TEXTURES^{1/2/}

SOIL TEXTURE	UNIFIED SOIL CLASSIFICATION	INFLOW RATE PER 1000 FT. OF LINE IN CFS
Coarse sand and gravel	GP, GW, SP, SW	0.15 to 1.00
Sandy or gravelly loam	SM, SC, GM, GC	0.07 to 0.25
Silt loam	CL, ML	0.04 to 0.10
Clay and clay loam	CL, CH, MH	0.02 to 0.20

1/ Required inflow rates for interceptor lines on sloping land should be increased by 10% for slopes 2% to 5%; 20% for slopes 5% to 12%; and 30% for slopes over 12%.

2/ For complete drainage systems, use the lower value in the above table for the given soil texture.

Size of Drain

The size of drains shall be computed by applying Manning's formula, or by the method contained in Chapter 14, Ref. (1).

The minimum drain shall be equivalent to a 4-inch diameter pipe.

Depth, Spacing, and Location

The depth, spacing, and location of the drain shall be based on site conditions including soils, groundwater conditions, topography, and outlets.

Minimum Velocity and Grade

In areas with no siltation hazard, the minimum grades shall be 0.1%. Where it is determined that a siltation hazard exists, velocity of not less than 1.4 feet per second shall be used to establish the minimum grades if site conditions permit. Otherwise, provisions shall be made for prevention of siltation by filters or collection and removal of silt by use of silt traps.

Maximum Grade and Protection

On sites where topographic conditions require the use of drain lines on grades steeper than 2% or where design velocities will be greater than indicated in Table 30-2 special measures shall be used. These measures shall be specified for each job based on the particular conditions of the job site. Possible protective measures include the following:

1. Lay the drains so as to secure a tight fit with the inside of one section matching that of the adjoining section.
2. Wrap open joints with geotextile filter.
3. Select the least erodible soil available for hand placing on sides and top of conduit, which must be tamped before backfilling. Tamped thickness of this material over conduit shall be a minimum of two inches.
4. For continuous pipe or tubing with perforations, completely enclose the pipe with geotextile filter material, or properly graded sand and gravel as specified under filters and filter materials on page 30-4.
5. Install relief vents where changes in grade exceed 5 percent.

TABLE 30-2

MAXIMUM PERMISSIBLE VELOCITIES IN DRAINS WITHOUT PROTECTIVE MEASURES

SOIL TEXTURE	VELOCITY - FEET PER SECOND
Sandy loam	2.5
Silt and silt loam	4.0
Silty clay loam	5.0
Clay and clay loam	6.0
Coarse sand and gravel	8.0

Materials for Drains

"Drains" include conduits of clay, concrete, metal, plastic, or other materials of acceptable quality.

The conduit shall meet strength and durability requirements of the site.

Loading

The allowable loads on drain conduits shall be based on the trench and bedding conditions specified for the job. A factor of safety of not less than 1.5 shall be used in computing the maximum allowable depth of cover for a particular type of conduit.

Filters and Filter Material

Suitable filters shall be used, where required by site conditions, to prevent sediment accumulation in the conduit. The need for a filter shall be determined by the characteristics of the soil materials at drain depth and the velocity of flow in the conduit.

Not less than three inches of filter material shall be used for sand-gravel filters.¹

Envelopes shall be used around drains where necessary to improve flow characteristics of groundwater into the conduit.

Installation Requirements

All drains shall be laid to line and grade, and covered with not less than three inches of approved hand placed backfill and/or filter material. The upper end of all drain lines shall be closed with concrete or other durable material unless connected to a structure.

Earth backfill material shall be placed in the trench in such a manner that displacement of the drain will not occur, and so that the filter material, after backfilling, will meet the requirements of the design.

The gap between drain pipe joints shall not exceed one-fourth inch for mineral soils or one-half inch for organic soils. Openings wider than these shall be covered with geotextile filter or other suitable material.

If the conduit is to be placed in a rock-trench, or where rock is exposed in the bottom of the trench, the rock shall be removed below grade deep enough so that the trench may be backfilled, compacted, and bedded so that the conduit is not less than two inches from rock.

When iron sulfide chemical reaction causes sealing of joints or perforations, the drain shall be enclosed in a clean sand-gravel filter. Riser pipes for flushing the line shall be provided at intervals not to exceed 500 feet.

¹ A recommended method of installation is to place filter material to a depth of three inches under the drain, and cover the drain and filter with a sheet of plastic. The filter shall be designed to prevent the material in which the installation is made from entering the drain. Not more than 10% of the filter shall pass the No. 60 sieve.

**STANDARD
FOR
TRAFFIC CONTROL**

Definition

The control of on-site construction traffic (construction equipment, service vehicles, autos, etc.) during development of a parcel of land.

Purpose

To minimize land disturbance.

Where Applicable

Any area where vehicular traffic disturbs the land to the extent of reducing protective vegetation, compacting soil, or otherwise deteriorating the environment.

Water Quality Enhancement

Managing construction traffic to minimize the damage or loss of protective vegetative cover and minimize the compaction of soils will help to minimize off-site erosion and transportation of associated pollutants.

Planning Criteria

Restrict construction traffic to predetermined routes according to types and numbers of vehicles anticipated. Markers or temporary fencing may be helpful.

Avoid damage to waterways by construction of suitable crossing facilities and avoid traffic in or along streams.

Predetermine steep banks and vegetative areas to be avoided by traffic.

Traffic during wet weather should be minimized.

Sediment from tire washing operations shall be retained on site. Water shall be conveyed to a stable outlet.

Soil compaction resulting from construction traffic can impact the infiltration rate of the soil. Restoration of compacted soils through deep tillage (6" to 12") and the addition of organic matter may be required, in accordance with the Standards for Topsoiling and Land Grading, in planned pervious areas to enhance the infiltration rate of the disturbed soil.

**STANDARD
FOR
FLOATING TURBIDITY BARRIER**

Definition

A temporary floating barrier at streams or waterways within the construction site.

Purpose

To prevent the siltation of streams or waterways that pass through or about the construction site.

Conditions Where Practice Applies

Floating turbidity barriers shall be used whenever construction operations are directly located in a stream or water course, or where a drainage pipe that may carry silt discharges into a stream or waterway.

Water Quality Enhancement

This practice will limit the dispersion of runoff-borne sediment (and floatable material) to the immediate area of construction, thereby facilitating maintenance and cleanup. Sediment trapped behind the barrier will be permitted to drop out of suspension before being carried further downstream.

Design Criteria

1. Barrier material will be a Polyethylene Plastic sheet, 10 mil., or suitable alternate to fit existing conditions.
2. Weights will be at 10' intervals along the entire length. They shall be 5 pounds and extend 12" below the bottom of the material.
3. Floats will be at 5' intervals; there will be two floats at each location, one on either side of the material.
4. Rope will be 1/4" nylon or manila.

Placement

1. Barrier will be set on a 50' radius from the point of discharge when discharging through a conduit. If the radius cannot be accommodated, barrier shall be placed in accordance with no. 3 below.
2. Barrier will extend parallel to the channel bank(s) for the full length of the work area for shoreline disturbances.
3. Barrier will extend across the entire channel when work is performed within the channel.

Figure 32-1: Placement of Floating Turbidity Barrier

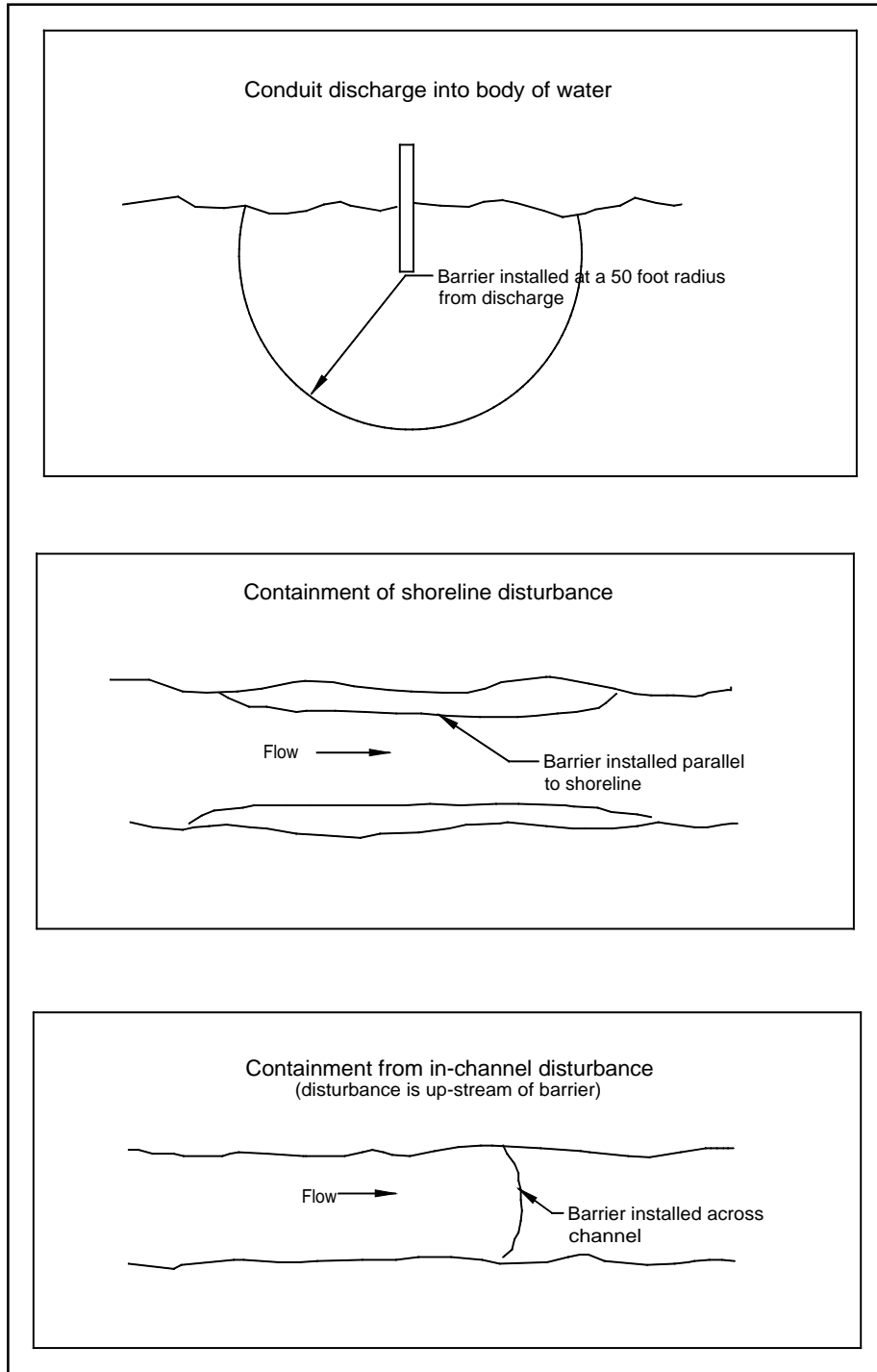

Appendix A1

THE UNIVERSAL SOIL LOSS EQUATION *

Determining Sediment Yield from Construction Sites and Development

Introduction

Sediment, a common term for eroded soil, is the most massive pollutant of surface water. Our growing population and high standards of living require construction of more houses, shopping centers, highways, waterways, and other facilities that involve clearing of vegetation and massive movement of soil. These activities expose the soil directly to the erosive actions of rain and flowing water. As a result, an enormous amount of soil is lost from these sites causing high turbidity to the water that carries it and damaging the site where it is finally deposited.

The Universal Soil Loss Equation, commonly known as the USLE, is a valuable technique for estimating erosion rates and evaluating various conservation practices for controlling erosion and sedimentation (deposition).

The Soil Erosion - Sedimentation Process

Since soil erosion and sedimentation by water are complex processes, a better understanding of them provides a sound basis for developing improved predictions and control methods. Soil erosion and sedimentation by water include detachment from the soil mass, transport downslope, and subsequent deposition. Soil is detached by raindrop impact and runoff shear forces, but man's activities that loosen and pulverize soil often promote accelerated erosion. Downslope transportation of eroding soil particles is primarily by channelized runoff. Generally, three distinct forms of erosion are seen in the upland areas. These are sheet erosion, rill erosion and gully erosion. Sheet erosion, also known as interrill erosion, takes place uniformly between rills or gullies. Sheet erosion results primarily from raindrop impact. The erosive potential of rain depends on its raindrop size, fall velocity and total mass at impact. Unless the soil surface is protected against raindrop impact by vegetation, mulches, or other cover, these raindrops can detach great quantities of soil and cause serious unnoticed interrill erosion.

Rill erosion is much more noticeable than interrill erosion. It is primarily the result of soil detachment by concentrated runoff, it causes intensive soil movement from a limited part of the land surface. Rills, which are small channels that can be easily smoothed, may first develop due to topographic variations, tillage marks, or random irregularities on the land surface. Rills carry both runoff from interrill areas and the rain that falls directly on them. Rill erosion increases rapidly as the slope steepens or lengthens and runoff rate increases.

Gully erosion is massive removal of soil by large concentrations of runoff. Gullies often start as rills and enlarge until they cannot be crossed by vehicles such as trucks and tractors. If permitted to form, gullies may yield tremendous volumes of sediment.

*Pages A1.1-A1.20 written by Dr. Devah Borah and presented at Cook College, Rutgers University, Sediment and Erosion Control Short Course, Spring 1986.

The quantity and size of material transported is a function of runoff velocity and turbulence, and these increase as the slope steepens and the flow increases. The larger the eroding material, the greater must be the flow velocity and turbulence to transport it. When the velocity or turbulence decreases, some of the eroded sediment may deposit. The largest and densest particles settle first while the finer particles are carried farther downslope or downstream.

Estimating Sediment Yield

The rate of sheet erosion depends on several factors as follows: (1) rainfall energy and intensity, (2) soil erodibility,

and (3) land slope and length of slope or topography, (4) condition of the soil surface and land management practices in use and (5) surface cover involved such as grass, woodland, crops, pavement or no cover at all. These factors may be assigned quantitative values to be used for computing soil loss by the Universal Soil Loss Equation, $E = RK (LS) C P$, where E is the estimated soil loss from sheet erosion in tons per acre per year. See ref. (3).

- R, the rainfall factor, is the number of erosion index in a normal year's rain. The erosion index is a measure of the erosive force of specific rainfall. See figure A1-I for values of R.
- K, the soil-erodibility factor, is the erosion rate per unit of erosion index for a specific soil in cultivated continuous fallow on a 9 percent slope 72.6 feet long. See Table A1-2a, A1-2b or A1-2c for values of K and (KR), the product of K and R, for New Jersey soils.
- L, the slope length factor, is the ratio of soil loss from the field gradient to that from a 9 percent slope. See Table A1-3 for values of (LS) for various slope gradient and length combinations.
- C, the cropping management factor, is the ratio of soil loss from a field with specified cropping management to that from the fallow condition on which the factor K is evaluated. This factor is also called the cover index and can be used to represent the effect of land cover or treatment that may be used to protect the construction site. See table A1-4 for values of the soil cover index Cc for treatment that may be used to protect construction sites.
- P, the erosion control practice factor, is the ratio of soil loss with the contour strip cropping or terracing to that with straight row farming up and down the slopes. The condition of the soil surface, particularly at construction sites, can also be reflected in the practice factor. See Table A1-5 for soil surface condition factors Pc for construction sites.

The value E may also be modified by a factor M shown on Table A1-6. M may be used to estimate the soil loss for a portion of a year and a portion of another year or more. The use of this factor provides a means of estimating the average soil loss on a critical sediment source area that will remain as such for a portion of a year or during the performance time of a construction contract.

The factor R is equal to the average annual value of the erosion index EI when the equation is being used to estimate average annual soil loss. This value of the equation may be modified to reflect soil loss probability and individual storm losses. Estimates of average soil loss, based on probability and single storm losses, can be made by multiplying the equation by the factors shown in Table A1-8. These factors reflect an alteration in the value of R and, therefore, the erosive effect of rainfall. They do not account for such things as snow melt, freezing, thawing and snow cover.

Detailed definitions and explanations for each of these factors are contained in Reference (3).

The soil information contained in Tables A1-2a, A1-2b and A1-2c are of general nature, useful for planning purposes. It should be used, without verification, for evaluation of construction sites for erosion control. Where erosion may be expected during construction involving earth moving, on-site investigations should include information on soils to be exposed as follows: (1) field identification and classification for both agriculture textures and the unified system, (2) sampling for grain size distribution, Atterburg limits and laboratory classification, and (3) in-place density as determined by a volumeter and the speedy moisture tester or other means.

The soil grain size is useful in determining the value of practices for the control of erosion and particularly sediment. For example, sediment basins will not be very effective for trapping very fine sediment. Soils made up of a high percentage of material with the grain size of 0.05 mm or less have a slow settling velocity in water. Material with a 0.05 mm grain size has a settling velocity close to 0.006 feet per second. This means that, theoretically, a detention time of about 15 minutes is required to settle out 0.05 mm material in 5 feet of still water.

Soil loss computed by the universal loss equation represents gross sheet erosion. This value plus erosion from the rilling, gullies and other sources is the gross erosion. To obtain sediment yield at the point downstream, the gross erosion must be adjusted downward by a delivery rate factor in percent equal to the ratio of sediment yield at the damage area to gross erosion. Delivery rates vary somewhere between 10 percent and 90 percent depending on conditions that tend to trap sediment between the source and the damage area.

Water pollution in the form of turbidity or discoloration may be as damaging to water supplies or swimming areas as the accumulation of sediment. Turbid water may be the result of algae or other organisms but generally it is caused by the fine silt or clay particles held in suspension. The very fine, divided clay particles found in some soils are difficult to control and may take months to settle out in still water.

Downstream damage from sediment depends on the following conditions:

1. Distance from the construction site to the nearest stream, pond or reservoir along with the condition of the vegetation and the slope of the area between the site and the stream of the reservoir. Areas with flat slopes and dense vegetation will tend to filter out sediment.
2. Once the sediment gets into a stream, the distance downstream to the damage point, such as a pond or water supply intake, is important. Also to be considered is the stream channel gradient and the flood plain width. Wide flat flood plains with dense vegetation will trap more sediment than steep narrow valleys.
3. The use of the stream or reservoir must be considered. It is very important to keep sediment out of streams used for fishing, recreation or water supply.
4. Another factor that should be considered is the size of the construction area and the length of time it will be bare of vegetative cover and subject to erosion. The total sediment expected should be compared with the capacity of the damage area to sustain sediment. If the total sediment to be expected from the site during the entire construction period is greater than can be tolerated in the damage area, considerable effort should be made to reduce it. If this cannot be done, arrangements to alleviate the damage should be made. These arrangements may include cleanout of ponds and reservoirs or restoration of stream channels.

A look at the Soil Loss Equation will show the factors over which man can exercise some control. These are lengths of slope, exposure time, and the total area exposed. Slope length is contained in the equation as part of the (LS) factor and its effect on soil loss can be evaluated. The length of time and time of year of soil loss from different size areas, can also be estimated.

"LS" Factor for Composite Slopes

LS values given in Table A1-3 predict the average soil loss for the entire length of a slope. Such a slope length is measured from the point where surface flow originates (usually the top of the ridge) to the outlet channel or a point down slope where deposition begins. When a slope steepens or flattens significantly toward the lower end, or is composed of a series of convex and concave segments, its overall average gradient and length do not correctly indicate the topographic effect on soil loss. Neither can successive slope segments be evaluated as independent slopes when runoff flows from one segment to the next. For irregular slopes values read from the aforementioned table must be adjusted to account for effects of the gradient changes.

The irregular slope is divided into a small number of equal-length segments in such a manner that, for practical purposes, the gradient within each segment can be considered uniform. The LS values corresponding to the steepness of each of the slope segments are read from table A1-3. While reading these values, the entire length of the irregular slope is taken. These LS values are multiplied by the corresponding factors given in the following table (Wischmeier, 1974). Each individual product is an estimate of LS value for the corresponding slope segment and the average of the products is an estimate of the effective LS value for the entire irregular slope. The procedure is valid only for situations

where upslope deposition is not possible.

FACTORS TO ADJUST "LS" VALUES FOR COMPOSITE SLOPES

Segment No. (Top to Bottom)	Adjustment Factors for Given Number of Equal-length Segments			
	2	3	4	5
1	0.71	0.58	0.50	0.45
2	1.29	1.06	0.91	0.82
3		1.37	1.18	1.06
4			1.40	1.25
5				1.42

"C" Values for Various Mulches Table A1-4 gives C values and slope-length limits for various nonseeded and seeded mulches used in controlling soil erosion. This table is taken from Meyer and Ports (1976). By using these values in the USLE, the effectiveness of various mulches can be determined in controlling soil erosion.

Sediment Delivery Ratio

Since the USLE predicts only the soil loss by rill and interrill erosion from the field-size areas, sediment yields from larger areas of watersheds must be estimated by adding additional erosion from gullies and streambanks along the flow path and subtracting eroded soil that is deposited at the base of a slope and elsewhere within the watershed. If additional gully or channel-type erosion is significant, it should be estimated and added to the predicted upland erosion to give the gross erosion occurring in the watershed above the location of interest. Deposition of eroded soil is accounted for simply using a sediment delivery ratio which is defined as the ratio of the sediment leaving the watershed to the estimated gross erosion on the watershed. Delivery ratios are generally much less than 1, because most natural slopes tend to flatten along their lower portions, which encourages deposition, and heavy vegetation often traps sediment below the upland slopes. However, urban erosion sources often lack locations where deposition is likely to occur and, in such cases, the delivery ratio will approach 1. Figure 2-4-2 gives delivery ratios for different soil texture and drainage areas. A general guide to sediment delivery ratios from construction sites is given as follows:

Guide To Delivery Ratio For Sediment From Construction Sites

Damage Area Condition (Reservoir,
stream reach or other area that could be damaged by sediment)

Estimated Delivery Rates \1

Less than 300 feet from the down
slope boundary of the construction
site.

.90

More than 300 feet down slope from the construction site but not downstream any appreciable distance	.70
Less than 1 mile downstream from the construction site (stream flows through or less than 300 feet from the slope boundary of site)	.60
Damage area more than 1 mile downstream or less.	.50

\1 New Jersey State Soil Conservation, "Sediment Pollution and Erosion Control Guide for Resource Conservation", Technical Guide, 1971. The values are based on judgement only. They should be considered as a general guide.

The Universal Soil Loss Equation has been widely adapted for use in estimating erosion rates and selecting sediment control practices for urban areas. It is a valuable design tool when properly applied, but its misuse can cause serious problems.

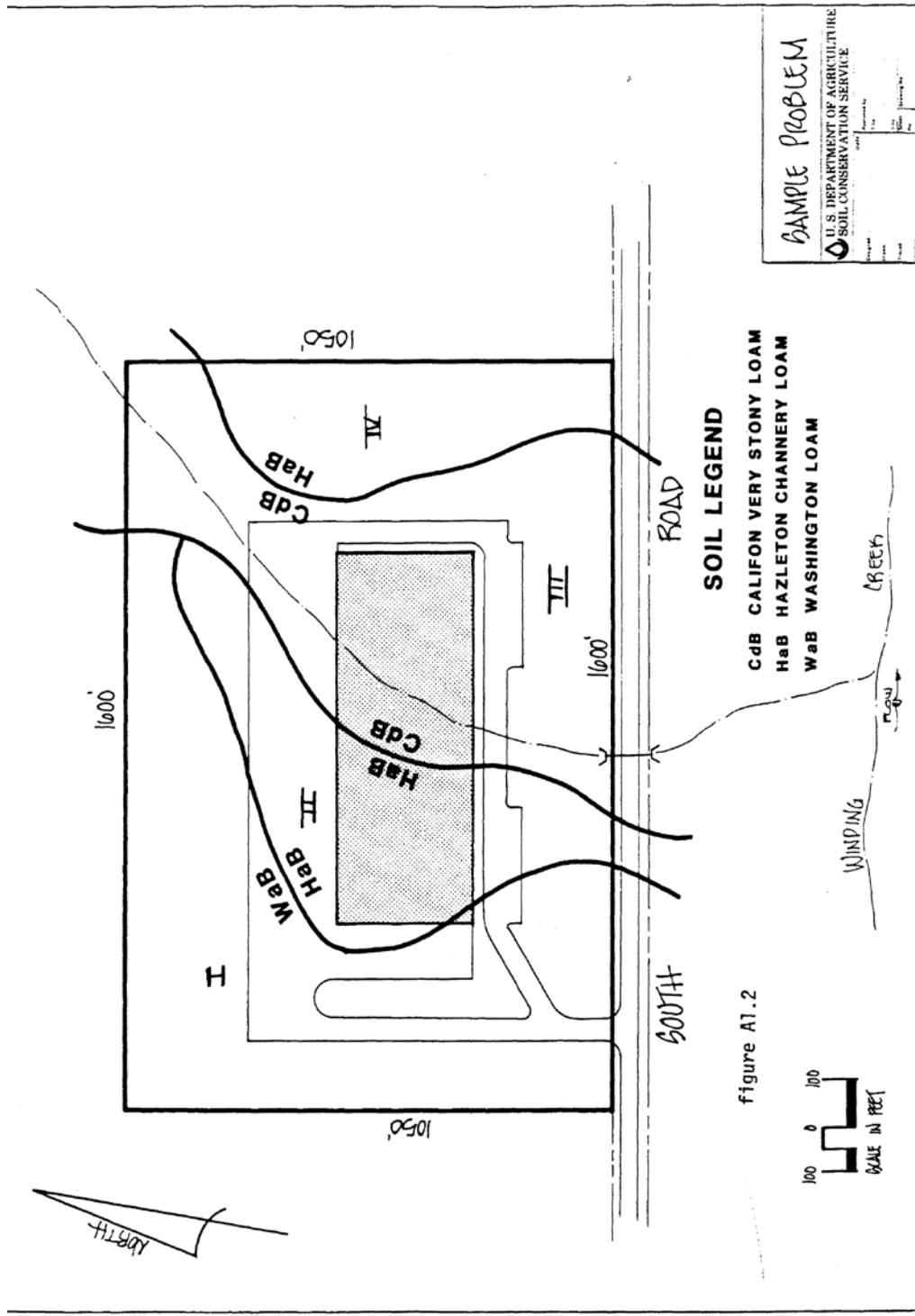

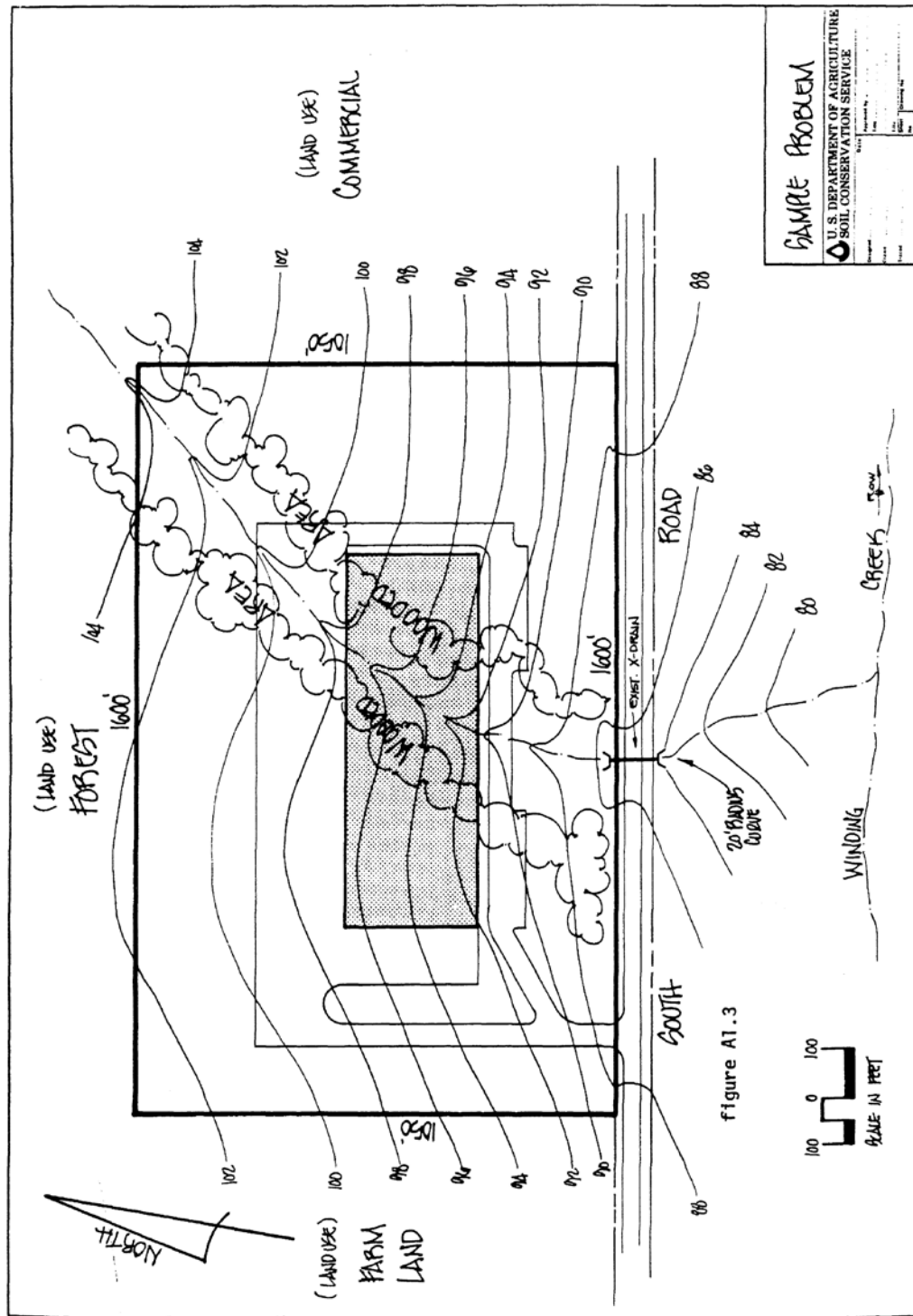

Sample Problem

Consider the following sample construction site. The site is located in the land resource area 148 of New Jersey. The land will be prepared for construction and will be exposed during an eighteen-month construction period starting from April 1 and ending on September 30 of next year. Assume that the upper edge of the site is a ridge so that there will be no overland flow contributing from the outside areas.

1. Required: For this site find the weighted soil erodibility factor.

Solution: Estimate the soil erodibility factor "K" as follows

Sub Area	Soil Series	Soil ¹ Profile (inches)	Area "a" (ac)	K (t/ac)	Area in Subarea "A" (ac)	Weighted ¹ K in subarea $\frac{ak}{A}$ (t/ac)	AK tons
I	WaB	0-9	10.4	0.28			
		9-52	4.1	0.32	14.5	0.29	4.2
II	HaB	0-6	1.7	0.17			
		6-56	5.1	0.15	6.8	0.16	1.1
III	CdB	0-10	6.9	0.17			
		10-50	5.7	0.30 ²	12.6	0.23	2.9
IV	HaB	0-6	4.7	0.17	4.7	0.17	0.8
Total:						38.6	9.0

$$\text{Weighted } K = \frac{\sum AK}{\sum A} = 9/38.6 = 0.23 \text{ t/ac (answer)}$$

Note:

The soil interpretation record of each soil series is used. In absence of these records, Table A1-2 can be used. Since the construction site has several soil series with different surface areas (Figure A1.2) and different K values, the composite K value must be weighted. Also, the soil profile which will be exposed for construction will be different at different locations (Figure A1.3). These differences must also be accounted for by further weighing.

¹ Assumed that the building and parking area is leveled around 95-ft contour

² $(0.32 + 0.28)/2 = 0.30$

NJ0040

SOIL INTERPRETATIONS RECORD

MLA(S): 144A, 148
 REV. MLN-WCK, 5-81
 TYPIC FRAGIUDULTS, FINE-LOAMY, MIXED, MESC

CALIFON SERIES
 STONY

THE CALIFON SERIES CONSISTS OF DEEP, MODERATELY WELL AND SOMEWHAT POORLY DRAINED SOILS ON UPLANDS. THEY FORMED IN GLACIAL TILL OR COLLUVIAL MATERIAL. TYPICALLY THESE SOILS HAVE A DARK BROWN VERY STONY LOAM SURFACE LAYER 10 INCHES THICK. THE SUBSOIL LAYERS FROM 10 TO 23 INCHES ARE STRONG BROWN LOAM AND CLAY LOAM. A VERY FIRM AND BRITTLE MOTTLED FRAGIPAN FROM 23 TO 50 INCHES IS MAINLY STRONG BROWN AND YELLOWISH-BROWN LOAM. THE SUBSTRATUM FROM 50 TO 75 INCHES IS YELLOWISH-BROWN SANDY LOAM. SLOPES RANGE FROM 0 TO 15 PERCENT.

ESTIMATED SOIL PROPERTIES (A)										
DEPTH (IN.)	USDA TEXTURE	UNIFIED	AASHTO	PERCENT OF MATERIAL LESS THAN 3" PASSING SIEVE NO.				LIQUID LIMIT	PLASTICITY INDEX	
				3	10	40	200			
0-10	STO	CL	A-4, A-6	3-10	80-100	60-95	55-80	50-70	20-30	12
10-23	CL, GR-L	ML, SM-SC, CL, CL-ML	A-4, A-6	3-10	85-100	60-95	55-90	45-70	23-40	15
23-50	CL, GR-SL	SM, ML, CL, SC	A-4, A-6, A-2	3-10	85-100	63-95	40-90	25-70	23-40	15
50-60	SL, CL, GR-LS	SM, ML, CL, SC	A-2, A-4, A-1, A-6	3-10	75-95	63-95	35-90	15-75	15-40	15

DEPTH (IN.)	CLAY (PCT)	MOISTURE BULK DENSITY (G/CM3)	PERCENT BULK DENSITY (IN/HR)	AVAILABLE WATER CAPACITY (IN/IN)	SOIL REACTION (PH)	SACIDITY DEPTH (MMHOS/CM)	SARFAK SWELL POTENTIAL	EROSION FACTORS	WIND EROD. GROUP	ORGANIC MATTER (PCT)	CORROSIVITY	
											STEEL	CONCRETE
0-10	0.6-2.0	0.16-0.20	4.0-5.0	4.0-5.0	4.0-5.0	4.0-5.0	LOW	17	3		HIGH	HIGH
10-23	0.6-2.0	0.10-0.20	4.0-5.0	4.0-5.0	4.0-5.0	4.0-5.0	LOW	32				
23-50	0.06-0.2	0.06-0.10	4.0-5.0	4.0-5.0	4.0-5.0	4.0-5.0	LOW	28				
50-60	0.6-2.0	0.14-0.18	4.0-5.0	4.0-5.0	4.0-5.0	4.0-5.0	LOW	28				

FLOODING		HIGH WATER TABLE		GENERATED PWA		BEDROCK		CONSIDERABLE FROST POTENTIAL	
FREQUENCY	DURATION	DEPTH (FT)	KIND	DEPTH (IN)	ADDRESS	DEPTH (IN)	ADDRESS	TOTAL GRP (IN)	FROST ACTION
NONE		0.5-2.5	PERCHEN	DEC-MAY		>60			C HIGH

SEPTIC TANK ABSORPTION FIELDS		SEWAGE LAGOON AREAS		SANITARY LANDFILL (TRENCH)		SANITARY LANDFILL (AREA)		DAILY COVER FOR LANDFILL	
SEVERE-WETNESS, PERCS SLOWLY		0-2%: SLIGHT 2-7%: MODERATE-SLOPE 7+%: SEVERE-SLOPE		SEVERE-WETNESS		SEVERE-WETNESS		0-8%: FAIR-CARGE STORES, SMALL STORES 8-15%: FAIR-SLOPE, LARGE STORES, SMALL STORES	
ROADFILL		SAND		GRAVEL		TOPSOIL		0-3%: MODERATE-SLOPE 3-8%: MODERATE-SLOPE, SLOPE 8+%: SEVERE-SLOPE	
IMPROBABLE-EXCESS FINES		IMPROBABLE-EXCESS FINES		POOR-LARGE STONES		POOR-FROST ACTION		WATER MANAGEMENT (B)	
BUILDING SITE DEVELOPMENT (B)		SHALLOW EXCAVATIONS		DWELLINGS WITHOUT BASEMENTS		DWELLINGS WITH BASEMENTS		SMALL COMMERCIAL BUILDINGS	
SEVERE-WETNESS		SEVERE-WETNESS, FROST ACTION		SEVERE-WETNESS		0-8%: SEVERE-WETNESS, FROST ACTION 8-15%: SEVERE-SLOPE, WETNESS, FROST ACTION		SEVERE-FROST ACTION	
EMBANKMENTS DIKES AND LEVEES		EXCAVATED PONDS AQUIFER FED		DRAINAGE		IRRIGATION		TERRACES AND DIVERSIONS	
SEVERE-PIPING, WETNESS		SEVERE-NO WATER		LARGE STORES, PERCS SLOWLY, WETNESS		LARGE STORES, PERCS SLOWLY, WETNESS		LARGE STORES, PERCS SLOWLY, ROOTING DEPTH	
LANDSCAPING AND GOLF FAIRWAYS		GRASSED WATERWAYS		REGIONAL INTERPRETATIONS					

CALIFORN SERIES		RECREATIONAL DEVELOPMENT (C)										NJ0045			
STONY		0-8Z: MODERATE-SLOPE, WETNESS, LARGE STONES					0-6Z: SEVERE-SMALL STONES, WETNESS								
CAMP AREAS		8-13Z: MODERATE-SLOPE, WETNESS, LARGE STONES					PLAYGROUNDS					6+Z: SEVERE-SLOPE, SMALL STONES, WETNESS			
PICNIC AREAS		0-8Z: MODERATE-SLOPE, WETNESS					8-13Z: MODERATE-SLOPE, WETNESS					MODERATE-SLOPE, WETNESS, LARGE STONES			
CLASS- DETERMINING PHASE		CAPABILITY AND YIELDS PER ACRE OF CROPS AND PASTURE (HIGH LEVEL MANAGEMENT)													
		CROP BILITY		PASTURE (AUM)		WHEAT		BARLEY		RYE		CORN			
0-3Z		55	6.0												
3-15Z		65	6.0												
CLASS- DETERMINING PHASE		ORD SYM		EROSION HAZARD		EQUIP. LIMIT		SEEDLING MORT'Y		WINDY HAZARD		PLANT COMPET.			
0-15Z		20		SLIGHT	SLIGHT	SLIGHT	SLIGHT								
CLASS- DETERMINING PHASE		SPECIES		SPECIES		SPECIES		SPECIES		SPECIES		SPECIES			
0-15Z		NONE													
CLASS- DETERMINING PHASE		GRAIN SEED		GRASS LEGUME		WILD HERB.		POTENTIAL FOR RAINFALL PLANTS		POTENTIAL AS HABITAT FOR WILDLIFE		POTENTIAL AS HABITAT FOR WETLAND WILDLIFE			
0-3Z		V. POOR	POOR	GOOD	GOOD	GOOD	GOOD	-	POOR	POOR	POOR	GOOD	POOR		
3-8Z		V. POOR	POOR	GOOD	GOOD	GOOD	GOOD	-	POOR	V. POOR	POOR	GOOD	V. POOR		
8-15Z		V. POOR	POOR	GOOD	GOOD	GOOD	GOOD	-	V. POOR	V. POOR	POOR	GOOD	V. POOR		
CLASS- DETERMINING PHASE		COMMON PLANT NAME		PLANT SYMBOL (NLSFN)		PERCENTAGE COMPOSITION (DRY WEIGHT) BY CLASS DETERMINING PHASE									
0-3Z															
3-8Z															
8-15Z															
CLASS- DETERMINING PHASE		POTENTIAL PRODUCTION (LBS/AC. DRY WT.)		FAVORABLE YEARS		NORMAL YEARS		UNEAVOURABLE YEARS							
0-3Z															
3-8Z															
8-15Z															

A ESTIMATES OF ENGINEERING PROPERTIES BASED ON TEST DATA OF 1 PEDON FROM MORRIS COUNTY, NEW JERSEY.
 B RATINGS BASED ON GUIDE FOR INTERPRETING ENGINEERING USES OF SOILS, NOV. 1971.
 1 RATINGS BASED ON NORTHEAST REGIONAL CRITERIA, MARCH 1966.
 C RATINGS BASED ON SOILS MEMOS 69, OCT. 1968; 26, SEPT. 1967; OR 74, JAN. 1972.

NJ0032 SOIL INTERPRETATIONS RECORD
 MLRA(S): 144A WASHINGTON SERIES
 REV. MCK, 9-79 STONY
 ULTIC HAPLUDALS, FINE-LOAMY, MIXED, MBSIC

THE WASHINGTON SERIES CONSISTS OF DEEP, WELL DRAINED SOILS ON UPLANDS. THEY FORMED IN GLACIAL TILL. TYPICALLY THESE SOILS HAVE A DARK YELLOWISH BROWN VERY STONY LAMP SURFACE LAYER 9 INCHES THICK. THE STRONG BROWN SUBSOIL FROM 9 TO 17 INCHES IS LOAM AND FROM 17 TO 52 INCHES IS CLAY LOAM. THE SUBSTRATUM FROM 52 TO 72 INCHES IS BROWNISH YELLOW LOAM GRADING TO GRAVELLY SILT LOAM WITH DEPTH. BEDROCK IS AT 72 INCHES. SLOPES RANGE FROM 0 TO 35 PERCENT.

ESTIMATED SOIL PROPERTIES (A)											
DEPTH (IN.)	USDA TEXTURE	UNIFIED	AASHTO	PERCENT OF MATERIAL LESS THAN 3" PASSING SIEVE NO.					LIQUID LIMIT	PLASTICITY INDEX	
0-9	STO-L	CL, SC, SM, ML	A-4, A-6	2-15	80-90	70-80	60-70	40-60	25-40	3-15	
9-52	CL, SIL, GR-L	CL, SC, ML, SM	A-4, A-6	0-5	75-100	60-95	50-90	35-85	25-40	3-15	
52-72	CL, SIL, GR-L	CL, SC	A-4, A-6, A-2, A-1	0-15	75-95	35-95	30-85	15-75	25-35	8-15	
72	UMB										

DEPTH (IN.)	MOISTURE CAPACITY (PCT)	SOIL DENSITY (G/CM3)	PERMEABILITY (IN/HR)	WATER CAPACITY (IN/IN)	SOIL REACTION (PH)	SALINITY (MMHOS/CM)	SWELL POTENTIAL	TEMPERATURE FACTORS	TORNSON TO EROD. MATTER GROUP (PCT)	ORGANIC MATTER	CORROSION
0-9	15-25	1.25-1.45	0.6-2.0	0.18-0.22	5.6-7.3	-	LOW	28	4	-	MODERATE
9-52	25-35	1.30-1.60	0.6-2.0	0.16-0.20	5.6-7.3	-	LOW	22	-	-	LOW
52-72	15-30	1.40-1.65	0.6-6.0	0.12-0.16	5.6-7.3	-	LOW	28	-	-	MODERATE
72											

FLOODING		HIGH WATER TABLE		CEMENTED PAV		BEDROCK		SUBSIDENCE		FROST	
FREQUENCY	DURATION	DEPTH (FT)	KIND	DEPTH (IN)	HARDNESS	DEPTH (IN)	HARDNESS	DEPTH (IN)	TOTAL GAP	FROST ACTION	MODERATE
		>6.0									

SANITARY FACILITIES (B)		CONSTRUCTION MATERIAL (B)	
SEPTIC TANK ABSORPTION FIELDS	0-8X: SLIGHT 8-15X: MODERATE-SLOPE 15+X: SEVERE-SLOPE	ROADFILL	0-25X: POOR-LOW STRENGTH 25+X: POOR-SLOPE, LOW STRENGTH
SEWAGE LAGOON AREAS	0-7X: SEVERE-SEEPAGE 7+X: SEVERE-SLOPE, SEEPAGE	SAND	IMPROBABLE-EXCESS FINES
SANITARY LANDFILL (TRENCH)	0-15X: SEVERE-SEEPAGE 15+X: SEVERE-SLOPE, SEEPAGE	GRAVEL	IMPROBABLE-EXCESS FINES
SANITARY LANDFILL (AREA)	0-15X: SEVERE-SEEPAGE 15+X: SEVERE-SLOPE, SEEPAGE	TOPSOIL	0-15X: POOR-LARGE STONES, SMALL STONES 15+X: POOR-SLOPE, LARGE STONES, SMALL STONES
DAILY COVER FOR LANDFILL	0-8X: FAIR-TOO CLAYEY, SMALL STONES 8-15X: FAIR-SLOPE, SMALL STONES, TOO CLAYEY 15+X: POOR-SLOPE	POND RESERVOIR AREA	0-3X: MODERATE-SEEPAGE 3-8X: MODERATE-SLOPE, SEEPAGE 8+X: SEVERE-SLOPE

BUILDING SITE DEVELOPMENT (B)		WATER MANAGEMENT (B)	
SHALLOW EXCAVATIONS	0-8X: SLIGHT 8-15X: MODERATE-SLOPE 15+X: SEVERE-SLOPE	EMBANKMENTS DIKS AND LEVEES	MODERATE-PIPING
DWELLINGS WITHOUT BASEMENTS	0-8X: SLIGHT 8-15X: MODERATE-SLOPE 15+X: SEVERE-SLOPE	EXCAVATED PONDS AQUIFER FED	SEVERE-NO WATER
DWELLINGS WITH BASEMENTS	0-8X: SLIGHT 8-15X: MODERATE-SLOPE 15+X: SEVERE-SLOPE	DRAINAGE	0-3X: FAVORABLE 3+X: SLOPE
SMALL COMMERCIAL BUILDINGS	0-8X: SLIGHT 4-8X: MODERATE-SLOPE 8+X: SEVERE-SLOPE	IRRIGATION	0-3X: FAVORABLE 3+X: SLOPE
LOCAL ROADS AND STREETS	0-8X: MODERATE-FROST ACTION 8-15X: MODERATE-SLOPE, FROST ACTION 15+X: SEVERE-SLOPE	TERRACES AND DIVERSIONS	0-8X: FAVORABLE 8+X: SLOPE
LAWNS, LANDSCAPING AND GOLF FAIRWAYS	0-8X: MODERATE-LARGE STONES, SMALL STONES 8-15X: MODERATE-SLOPE, LARGE STONES, SMALL STONES 15+X: SEVERE-SLOPE	GRASSED WATERWAYS	0-8X: FAVORABLE 8+X: SLOPE

REGIONAL INTERPRETATIONS	

WASHINGTON SERIES
STONY

MJ0032

		RECREATIONAL DEVELOPMENT (C)											
CAMP AREAS	0-8%: MODERATE-SLOPE, SMALL STONES, DUSTY	PLAYGROUNDS				0-6%: SEVERE-SMALL STONES, LARGE STONES							
	8-15%: MODERATE-SLOPE, LARGE STONES, SMALL STONES					6+%: SEVERE-SLOPE, LARGE STONES, SMALL STONES							
	15+%: SEVERE-SLOPE												
PICNIC AREAS	0-8%: MODERATE-SMALL STONES, LARGE STONES, DUSTY	PATHS AND TRAILS				0-15%: MODERATE-SLOPE, SMALL STONES, DUSTY							
	8-15%: MODERATE-SLOPE, SMALL STONES, LARGE STONES					15-25%: MODERATE-SLOPE, LARGE STONES, SMALL STONES							
	15+%: SEVERE-SLOPE					15%: SEVERE-SLOPE							
CLASS- DETERMINING PHASE		CAPABILITY AND YIELDS PER ACRE OF CROPS AND PASTURE (HIGH LEVEL MANAGEMENT)											
		LAVA-BILITY											
		NIRN TIRN											
0-3% 3-25% 25-35%		-											
CLASS- DETERMINING PHASE		WOODLAND SOILABILITY (C)				POTENTIAL PRODUCTIVITY							
		EROSION HAZARD	EQUIP. LIMIT	SEEDLING MORT %	WINDTR. HAZARD	PLANT CONPET.	COMMON TREES	SITE INDEX	TREES TO PLANT				
0-15% 15-35%		SLIGHT	SLIGHT	SLIGHT	SLIGHT		NORTHEAST RED OAK YELLOW-POPLAR	85 95	EASTERN WHITE PINE EUROPEAN LARCH BLACK WALNUT YELLOW-POPLAR NORWAY SPRUCE				
CLASS- DETERMINING PHASE		WINDBREAKS											
		SPECIES		TWT		SPECIES		TWT					
		NONE											
CLASS- DETERMINING PHASE		WILDLIFE HABITAT SOILABILITY (C)						POTENTIAL AS HABITAT FOR					
		POTENTIAL FOR HABITAT ELEMENTS						WETLANDS					
		GRAIN	WILDS	WILDS	WILDS	WILDS	WILDS	WILDS	WILDS	WILDS	WILDS		
0-8% 8-35%		V. POOR	POOR	GOOD	GOOD	GOOD	POOR	V. POOR	POOR	POOR	GOOD	V. POOR	
CLASS- DETERMINING PHASE		POTENTIAL RATIO OF PLANT COMMUNITY (PERCENTAGE COMPOSITION DRY WEIGHT) BY CLASS DETERMINING PHASE											
		COMMON PLANT NAME											
		PLANT SYMBOL (NLSFN)											
		POTENTIAL PRODUCTION (LBS/7AC. DRY WTY): FAVORABLE YEARS, NORMAL YEARS, UNFAVORABLE YEARS											

FOOTNOTES
 A ESTIMATES OF ENGINEERING PROPERTIES BASED ON TEST DATA OF 10 PEDONS FROM PENNSYLVANIA.
 B RATINGS BASED ON NSH, PART II, SECTION 403, 3-78.
 C RATINGS BASED ON SOILS MEMO 26, SEPT. 1967, AND REGIONAL CRITERIA. SITE INDEX VALUES + OR -5 OR MORE.
 D WILDLIFE RATINGS BASED ON SOILS MEMO 74, JAN. 1972.
 I EXCESSIVE PERMEABILITY RATE MAY ALLOW POLLUTION OF GROUND WATER.

PA0080

SOIL INTERPRETATIONS RECORD

MLBA(S): 147, 149, 126, 127, 124

HAZLETON SERIES

REV. GNL. 9-83

TYPIC DYSTROCHEPTS, LOAMY-SKELETAL, MIXED, MESIC

THE HAZLETON SERIES CONSISTS OF DEEP, WELL DRAINED SOILS ON UPLANDS. THEY FORMED IN MATERIAL WEATHERED FROM SANDSTONE. TYPICALLY, THESE SOILS HAVE A DARK BROWN SANDY LOAM SURFACE LAYER, 6 INCHES THICK, THE SUBSOIL BETWEEN 6 AND 32 INCHES IS REDDISH-YELLOW TO STRONG BROWN CHANNERY AND VERY CHANNERY SANDY LOAM. THE SUBSTRATUM FROM 32 TO 56 INCHES IS REDDISH-YELLOW VERY CHANNERY SANDY LOAM. SANDSTONE BEDROCK IS AT A DEPTH OF 56 INCHES. SLOPES RANGE FROM 0 TO 80

HAZLETON SERIES

PA0080

RECREATIONAL DEVELOPMENT (B)															
CAMP AREAS		0-8Z SL.L.FSL: SLIGHT 0-8Z CM: MODERATE-SMALL STONES 8-15Z SL.L.FSL: MODERATE-SLOPE 8-15Z CM: MODERATE-SLOPE, SMALL STONES 15+Z: SEVERE-SLOPE				PLAYGROUNDS				0-2Z SL.L.FSL: SLIGHT 2-6Z SL.L.FSL: MODERATE-SLOPE 6+Z CM: SEVERE-SMALL STONES 6+Z CM: SEVERE-SMALL STONES, SLOPE					
PICNIC AREAS		0-8Z SL.L.FSL: SLIGHT 0-8Z CM: MODERATE-SMALL STONES 8-15Z SL.L.FSL: MODERATE-SLOPE 8-15Z CM: MODERATE-SLOPE, SMALL STONES 15+Z: SEVERE-SLOPE				PATHS AND TRAILS				0-15Z: SLIGHT 15-25Z: MODERATE-SLOPE 25+Z: SEVERE-SLOPE					
CAPACITY AND YIELDS PER ACRE OF CROPS AND PASTURE (HIGH LEVEL MANAGEMENT)															
CLASS DETERMINING PHASE	CAPACITY	CORN		WHEAT		OATS		ALFALFA HAY		LEGUME HAY		PASTURE		CORN SILAGE	
		(BU)	(T)	(BU)	(T)	(BU)	(T)	(T)	(T)	(T)	(T)	(T)	(T)	(T)	(T)
0-3Z	1.2E	145	45	45	75	4.5	3.5	8.0	4.5	3.5	8.0	4.5	3.5	8.0	23
3-8Z	2E	125	45	45	75	4.5	3.5	8.0	4.5	3.5	8.0	4.5	3.5	8.0	23
8-15Z	3E	115	40	40	60	4.0	3.0	7.5	4.0	3.0	7.5	4.0	3.0	7.5	22
15-25Z	4E	110	35	35	-	-	-	-	-	-	-	-	-	-	-
25-35Z	5E	-	-	-	-	-	-	-	-	-	-	-	-	-	-
35+Z	7E	-	-	-	-	-	-	-	-	-	-	-	-	-	-

WOODLAND SOILABILITY (C)																	
CLASS DETERMINING PHASE	ORD SYM	EROSION HAZARD				SEEDLING MORTY				WINDHURZ PLANT COMPET.				POTENTIAL PRODUCTIVITY		TREES TO PLANT	
		SLIGHT	MODERATE	SEVERE	HAZARD	SLIGHT	MODERATE	SEVERE	HAZARD	SLIGHT	MODERATE	SEVERE	HAZARD	INDEX	INDEX	INDEX	INDEX
0-15Z	3E	SLIGHT	MODERATE	SEVERE	SLIGHT	MODERATE	SEVERE	SLIGHT	MODERATE	SEVERE	SLIGHT	MODERATE	SEVERE	70	80	JAPANESE LARCH	EASTERN WHITE PINE
15-35Z NORTH	3E	SLIGHT	MODERATE	SEVERE	SLIGHT	MODERATE	SEVERE	SLIGHT	MODERATE	SEVERE	SLIGHT	MODERATE	SEVERE	70	80	NORWAY SPRUCE	AUSTRIAN PINE
35+Z NORTH	3E	SLIGHT	MODERATE	SEVERE	SLIGHT	MODERATE	SEVERE	SLIGHT	MODERATE	SEVERE	SLIGHT	MODERATE	SEVERE	70	80	BLACK CHERRY	JAPANESE LARCH
15-35Z SOUTH	4E	SLIGHT	MODERATE	SEVERE	SLIGHT	MODERATE	SEVERE	SLIGHT	MODERATE	SEVERE	SLIGHT	MODERATE	SEVERE	60	60	EASTERN WHITE PINE	NORWAY SPRUCE
35+Z SOUTH	4E	SLIGHT	MODERATE	SEVERE	SLIGHT	MODERATE	SEVERE	SLIGHT	MODERATE	SEVERE	SLIGHT	MODERATE	SEVERE	60	60	AUSTRIAN PINE	BLACK CHERRY

WINDBREAKS														
CLASS DETERMINING PHASE	SPECIES	HT	SPECIES	HT	SPECIES	HT	SPECIES	HT	SPECIES	HT	SPECIES	HT	SPECIES	HT
ALL	SIBERIAN PEARS	10	RUSSIAN HONEYSUCKLE	10	AROR HONEYSUCKLE	10	WILLOW	10	WILLOW	10	WILLOW	10	WILLOW	10
	AUTUMN OLIVE	12	WASHINGTON HAWTHORN	10	RADIANT CRABAPPLE	10	WILLOW	10	WILLOW	10	WILLOW	10	WILLOW	10
	JACK PINE	16	AUSTRIAN PINE	18	RED PINE	18	WILLOW	10	WILLOW	10	WILLOW	10	WILLOW	10

WILDLIFE HABITAT SOILABILITY (C)																				
CLASS DETERMINING PHASE	GRAIN		GRASS		WILD HERB		HARDWOOD TREES		CONIFER PLANTS		SHRUBS		WETLAND		SACALLOT OPENLD		WOODLD		WETLAND WANGLD	
	SEED	LEGUME	SEED	LEGUME	SEED	LEGUME	SEED	LEGUME	SEED	LEGUME	SEED	LEGUME	SEED	LEGUME	SEED	LEGUME	SEED	LEGUME	SEED	LEGUME
0-8Z	GOOD	GOOD	GOOD	GOOD	GOOD	GOOD	GOOD	GOOD	GOOD	GOOD	GOOD	GOOD	GOOD	GOOD	GOOD	GOOD	GOOD	GOOD	GOOD	GOOD
8-15Z	FAIR	GOOD	GOOD	GOOD	GOOD	GOOD	GOOD	GOOD	GOOD	GOOD	GOOD	GOOD	GOOD	GOOD	GOOD	GOOD	GOOD	GOOD	GOOD	GOOD
15-25Z	POOR	FAIR	GOOD	GOOD	GOOD	GOOD	GOOD	GOOD	GOOD	GOOD	GOOD	GOOD	GOOD	GOOD	GOOD	GOOD	GOOD	GOOD	GOOD	GOOD
25-35Z	V. POOR	FAIR	GOOD	GOOD	GOOD	GOOD	GOOD	GOOD	GOOD	GOOD	GOOD	GOOD	GOOD	GOOD	GOOD	GOOD	GOOD	GOOD	GOOD	GOOD
35+Z	V. POOR	POOR	GOOD	GOOD	GOOD	GOOD	GOOD	GOOD	GOOD	GOOD	GOOD	GOOD	GOOD	GOOD	GOOD	GOOD	GOOD	GOOD	GOOD	GOOD

POTENTIAL RATIOES PLANT COMMUNITY (BARCELAND OR FOREST UNDERSTORY VEGETATION)													
COMMON PLANT NAME	PLANT SYMBOL (MLSPN)	PERCENTAGE COMPOSITION (DRY WEIGHT) BY CLASS DETERMINING PHASE											

POTENTIAL PRODUCTION (LBS./AC. DRY MAT.)			
FAVORABLE YEARS	NORMAL YEARS	UNFAVORABLE YEARS	

A ESTIMATES OF ENGINEERING PROPERTIES BASED ON TEST DATA OF 16 PEDONS FROM PENNSYLVANIA.
 B RATINGS BASED ON NSH, PART II, SECTION 403, 3-78.
 C RATINGS BASED ON SOILS MEMOS 26, SEPT. 1967; OR 74, JAN. 1972.

2. Required: For this site, estimate the Topographic Factor "LS"

Solution:

<u>"LS" for Subarea "A" (11.6 acres)</u>					
Segment No.	Slope %	"LS" form Table A1-3	Adjustment Factor	Segment "LS"	
1	1	0.21	0.71	0.15	
2	2	0.33	1.29	0.43	
				Average LS: 0.29	

Subarea A will have original slope

<u>"LS" for Subarea "B" (27.0 acres)</u>					
Segment No.	Slope %	"LS" form Table A1-3	Adjustment Factor	Segment "LS"	
1	1	0.27	0.45	0.12	
2	2	0.41	0.82	0.34	
3	0.2 *	0.17	1.06	0.18	
4	0.2 **	0.17	1.25	0.21	
5	5	1.70	1.42	2.41	
				Average LS: 0.65	

Weighted LS = [(0.29)(11.6) + (0.65)(27.0)]/38.6 = 0.54 (answer)

Note:

Subarea B will be reshaped for construction. Assume that the building area is almost horizontal around 96-ft. elevation.

3. Required: Estimate the annual soil erosion rate from the construction site without any control measure. At what rate will this sediment be arriving at the Winding Creek?

Solution:

1. Using the Universal Soil Loss Equation $E = R K LS C P$

R: from Figure A1-1, R value in Hunterdon County is 175

K: weighted K value previously calculated is 0.23 t/ac

1. (cont'd)

LS: weighted LS factor previously calculated is 0.54

C: no cover, therefore C is 1.0

P: no control practices, P = 1.0

2. The estimated average soil loss from sheet erosion (E) in tons per acre per year is:

$$E = (175) (0.23) (0.54) (1.0) (1.0) \\ 22 \text{ tons/acre/year}$$

3. The erosion from the entire site (sediment yield)

$$22 \text{ tons/acre/year} \times 38.6 \text{ acres} = 849 \text{ tons/year}$$

4. Delivery Ratio (DR): The Winding Creek is about 600 feet downstream of the construction site. Based on the values

given previously assume DR = 0.7

5. Sediment reaching the Winding Creek is:

$$0.7 \times 849 \text{ tons/year} = 594 \text{ tons/year (answer)}$$

4. **Required:** What would the soil erosion be for an extreme year of one in 20 years and for a major single storm of one in 20 years?

Solution:

1. Soil erosion for an extreme year of one in 20 years can be determined as follows:

a. Probability factor of one in 20 years (Table A1-8) is 1.7

b. Soil erosion for this year is $1.7 \times 849 \text{ tons/year}$ or 1443 tons/year (answer)

2. Soil Erosion for a major storm of one in 20 years can be determined as follows:

a. The factor in table A1-8 is 0.7, therefore the soil erosion for the storm is $0.7 \times 849 \text{ tons/year}$ or 594 tons/year (answer).

5. **Required:** What would the reduction of annual soil erosion be (in percent) if the slope length is divided into five equal slope lengths by using diversions? What would the reduction be if straw or hay mulch at a rate of 1.5 T/ac is properly used in each of the above slope length segments?

Solution:

1. Divide the slopes into five equal slope lengths (Figure A1-2) and determine the effect of the slope length change:

Each slope-length will be 210 feet. "LS" factor, as well as the erosion rate, for each slope-length is computed

individually.

Erosion from Subarea A

Segment <u>No.</u>	Slope (%)	"LS" from <u>Table A1-3</u>	Area A (acres)	Annual Soil Loss <u>ARKLS (tons/year)</u>
1	1	0.16	2.32	14.9
2	1	0.16	2.32	14.9
3	2	0.25	2.32	23.3
4	2	0.25	2.32	23.3
5	2	0.25	2.32	23.3

Total from Subarea A is 100 tons/year

Erosion from Subarea B

Segment <u>No.</u>	Slope (%)	"LS" from <u>Table A1-3</u>	Area B (acres)	Annual Soil Loss <u>ARKLS (tons/year)</u>
1	1	0.16	5.4	34.8
2	2	0.25	5.4	54.3
3	0.2	0.10	5.4	21.7
4	0.2	0.10	5.4	21.7
5	5	0.78	5.4	169.5

Total from Subarea B is 302 tons/year

Therefore the total soil loss is $100 + 302 = 402$ tons/year. The percent reduction would therefore be $(849-409)/849 \times 100 = 53$ percent (answer)

2. The soil loss reduction from the slope length change and from adding mulch is as follows:

- From table A1-4 for slopes that are < 5 percent and lengths less than 300 feet, the cropping management factor (C) is 0.12
- Soil loss with straw or hay mulch (1.5 tons/year) on the five equal segments is $402 \text{ tons/year} \times 0.12 = 48 \text{ tons/year}$
- Reduction of annual soil loss $(849-48)/849 \times 100$ or 94 percent (answer)

6. **Required:** Assume that the only control measure adopted in this site is a sediment basin which will be constructed at the downstream edge of the property. For what sediment volume will this basin be designed?

Solution:

- Since the sediment basin will be built at the downstream edge of the site, $DR = 1.0$
- The rate of sediment which will enter the basin is 849 tons/year.
- The adjustment factor, M (Table A1-6), for the 18 month construction period (April 1, 1986 to September 30, 1987):

April 1, 1986 to March 1, 1987: M = 0.98

March 1, 1987 to October 1, 1987 M = 0.82

Total M = 1.80

4. Total sediment which will arrive at the basin during the construction period is $E_t = 849 \text{ tons/year} \times 1.80$ or 1528 tons.

5. Using Table A1-7, the saturated sediment volume for which the sediment basin will be designed is:

$1528 \times .00077 = 1.18$ acre-feet

or

$1528 \times 1.24 = 1895$ cu. yd. (answer)

FIGURE A1-1

RAINFALL EROSION VALUES "R"
NEW JERSEY MAP

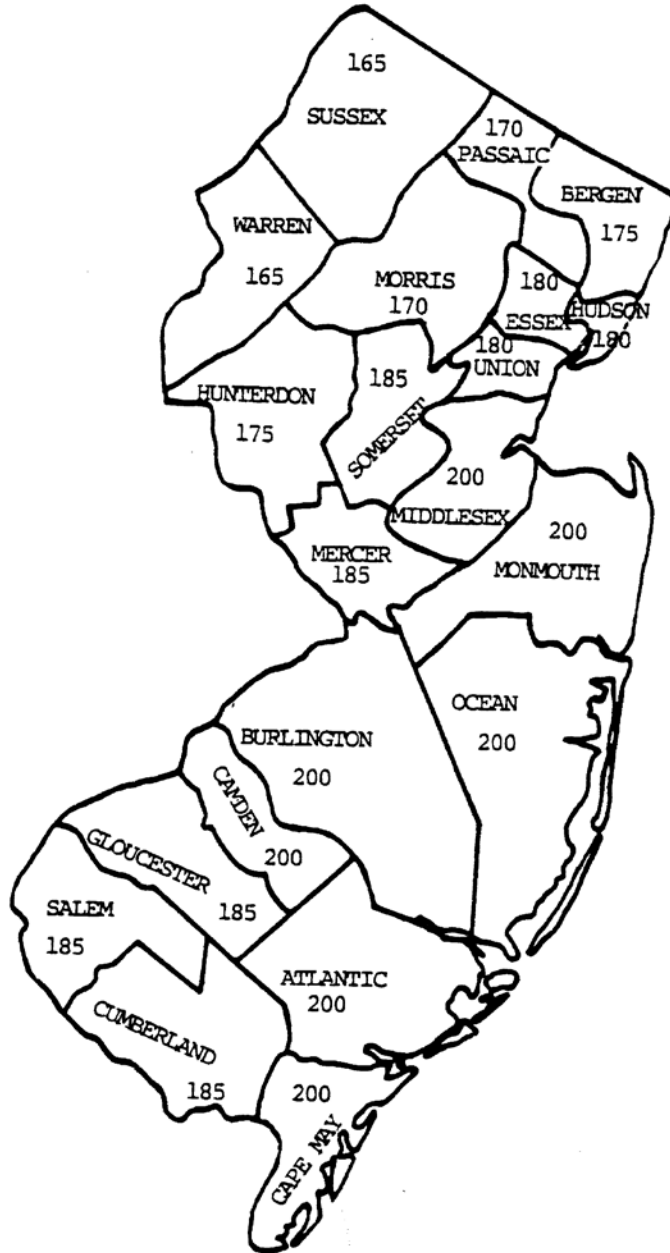

TABLE A1-1

USDA TEXTURE ABBREVIATIONS USED IN TABLE A1-2a, A1-2b, A1-2c

c	-	clay, clayey
ch	-	channery
co	-	coarse
e	-	extremely
f	-	fine
g	-	gravelly
k	-	cobbly
l	-	loam, loamy
m	-	muck
r	-	rocky
s	-	sand, sandy
sh	-	shaly
si	-	silt, silty
st	-	stony
v	-	very

SOIL-ERODIBILITY CLASSES

K	-	class
0.17 - 0.24	-	low
0.28 - 0.37	-	medium
0.43 - 0.49	-	high

TABLE A1-2a EROSION PROPERTIES OF SOILS IN NEW JERSEY
LAND RESOURCE AREA 144, R= 175

Soil Series (Alpha Listing)	Local ⁱ Mapping No.	Typical Profile (inches)	USDA Texture Range	Unified System	K	KR
Adrian		0-42	m	Pt	--	--
		42-60	ls	SP-SM,SM	0.2	35
Albia		0-16	gl,estl	GM,GC,SC	0.24	42
		16-40	gl (pan)	GM,GC,SC	0.4	70
		40-60	gl	GM,GC,SC	0.3	53
Asbury		0-30	sil	GL,ML	ii	--
		30-60	ls,gl,vgls	SM,GM	--	--
Atherton		0-30	l	SM,SC,ML,CL	0.24	42
		30-60	scl	SM,SC	0.2	35
Bartley		0-11	l,g	ML,CL	0.32	56
		11-32	cl,l,scl	ML,CL	0.3	53
		32-42	sl,l	SM,SC	0.2	35
		42-60	sl,l,gs,gl	SM,SC	0.2	35
Bath		0-28	l,sil	SM,SC	0.24	42
			gl,vstl	GM,GC	0.17	30
		28-48	l,sil	SM,SC	0.2	35
			gl,gsil	GM,GC	0.2	35
Beatty		48-60	gs,gl	SM,SC,GM,GC	0.2	35
		0-25	l	CL,ML	2	--
		25-60	ls,gl	SM,GM	--	--
Biddeford		0-8	ml	Pt	--	--
		8-18	sil	ML,CL	--	--
		18-44	sic,cl	CL,CH	--	--
		44-60	sil,cl,sic	ML,CL	--	--
Boonton		0-6	gl,estl	ML	0.20	35
		6-30	fs,sl,sil,gfsl,gl,gs	ML,CL	0.2	35
		30-45	fs,sl,sil,gfsl,gsil	ML,CL,SM,SC	0.2	35
		45-60	gs,gl	SM	0.2	35
Braceville		0-24	gs,gl	SM,GM	0.24	42
		24-36	g or vg, l,sl	SM,SC,GM	0.3	53
		36-60	stratified scg	SM,SP,SP-SM,GP	0.2	35
Bridgeville		0-30	sl,gl	SM	0.24	42
		30-60	gl,g,s	SM	0.2	35
Burnham		0-12	l,sil	ML,CL	0.32	26
		12-48	gl	ML,CL	0.3	53
		48-60	stone,g	SM,SC,GM,GC	0.2	35

TABLE A1-2a EROSION PROPERTIES OF SOILS IN NEW JERSEY
LAND RESOURCE AREA 144, R= 175

Soil Series (Alpha Listing)	Local ⁱ Mapping No.	Typical Profile (inches)	USDA Texture Range	Unified System	K	KR
Carlisle		0-60	m	Pt	--	--
Cattaraugus		0-20	fsl	SM,ML,CL	0.24	42
		20-60	gl	SM,ML,CL	0.17	30
Chatfield		0-28	l	ML,CL	0.17	30
		28+	gneiss bedrock			
Chenango		0-20	sl	SM	0.24	42
			gfsl,ksl	GM	0.17	30
		20-30	vgsl,gsl	SM,GM	0.2	35
		30-60	g,s,gls	GP-GM,GM	0.2	35
Chippewa		0-13	sil	ML,CL	0.32	56
			chsil,estl	ML,CL	0.24	42
		13-50	l,chsil(pan)	ML,CL,GM	0.4	70
Colden		0-8	sil	ML,CL	0.43	75
		8-45	sicl	ML	0.4	70
Colonie		0-16	lfs,ls	SM,SP-SM	0.24	42
		16-60	fs,ls,lfs	SM,SP-SM	0.2	35
Comly		0-11	sil	ML,CL	0.37	65
		11-20	sicl,l,sil	ML,CL,CH	0.4	70
		20-27	sicl(pan)	ML,CL,CH	0.5	88
		27-40	sil,l,sicl	ML,CL,CH	0.3	53
Coplay		0-10	sil	ML,CL	0.32	56
		10-60	sicl,cl	ML,CL	0.3	53
Cossayuna		0-24	l,vfsl	SM,ML,CL	0.24	42
			gl	SC,GM,GC	0.17	30
		24-48	g,gl (pan)	SC,GM,GC,SM,ML	0.3	53
		48-60	gsl	SM,GM	0.2	35
Crestmore		0-30	l,sil	ML,CL	0.32	56
		30+	bedrock			
Culvers		0-16	fsl	SM,ML,CL	0.28	49
			chsil	SM,ML,CL	0.20	35
		16-45	l	ML	0.3	53
			chsil	ML,CL,GM	0.3	53
Dutchess		0-60	sil,l,shl,shsil	GM,SM	0.20	35
Ellington		0-15	l,fsl	ML,SM	0.24	42
			gl,gsl	ML,SM	0.24	42
		15-38	l,sl	ML,SM	0.3	53

TABLE A1-2a EROSION PROPERTIES OF SOILS IN NEW JERSEY
LAND RESOURCE AREA 144, R= 175

Soil Series (Alpha Listing)	Local ⁱ Mapping No.	Typical Profile (inches)	USDA Texture Range	Unified System	K	KR
Fredon			gl,gsl	ML,SM	0.2	35
		38-60	s,gs	SM,SP-SM,GM	0.2	35
		0-7	l	ML,CL,SM	0.24	42
		7-30	sl,fsl	SM,ML,CL	0.3	53
Hackettstown			gsl,gfsl	SM,ML,CL	0.2	35
		30-60	s,g	GP-GM,SP-SM	0.2	35
		0-30	sl	SM	0.24	42
Haledon			gsl	SM,GM	0.17	30
		30-60	gls,gsl	SM,GM	0.2	35
		0-10	sil,gsil	ML,CL	0.32	56
Halsey		10-46	sil,l,fsl	ML,CL	0.3	53
			gsil,gl,gfsl			
		46-60	vfsil,sl,gvfsil,gsl	SM,SC	0.2	35
		0-24	l	ML,SM	0.24	42
Hazen		24-30	fsl,l,sl	SM	0.3	53
		30-60	g,gs,s & g	GP,GM,SM,SP	0.2	35
		0-12	gsl,gl	ML,CL	0.17	30
Hero		12-32	gl	ML,CL	0.2	35
		32-60	g & S	SM	0.2	35
		0-10	l	SM,ML,CL	0.24	42
Hibernia		10-24	fsl,gsl	SM	0.2	35
		24-60	s,gs	SM,GM	0.2	35
		0-25	l	ML,CL,SM,SC	0.37	65
			gl,sl,vstl	ML,CL,SM,SC	0.32	56
Holyoke		25-36	l,scl,sl,	ML,CL,SM,SC	0.3	53
			gl,gscl,gsl	SM,SC,GM,GC	0.3	53
		36-72	gls,gsl,cls	SM,GM	0.2	35
		0-17	rsil	ML,CL	0.24	42
Hoosic		17+	Bedrock			
		0-15	gl,gsl	SM,GM,ML,CL	0.17	30
		15-26	gsl,vgsl	GM,SM,ML,CL	0.2	35
Kendaia		26-60	s & g	SW,GW,SM,GM, SP,GP	0,2	35
		0-8	sil,l,fsl	ML	0.28	49
		8-20	sil,l	ML,ML-CL ML-CL,ML,SM	0.4 0.4	70 70

TABLE A1-2a EROSION PROPERTIES OF SOILS IN NEW JERSEY
LAND RESOURCE AREA 144, R= 175

Soil Series (Alpha Listing)	Local ⁱ Mapping No.	Typical Profile (inches)	USDA Texture Range	Unified System	K	KR
				ML-CL,ML,SM GM-GC	0.3	53
Kistler		0-14	shsil	ML,CL	0.24	42
		14-24	vshsil	ML,CL,GM	0.2	35
		24+	slate bedrock			
Lackawana		0-26	l	ML,CL	0.24	42
			chsil	ML,CL	0.17	30
		26-52	chl (pan)	ML,CL	0.3	53
Livingston		0-10	si,sicl	ML,CL	0.49	86
		10-50	sic	ML,CL,MH,CH	0.5	88
Lyons		0-9	vstsil	CL,ML,SM,SC	0.28	49
		9-18	sil,fsl,sicl	SM,SC,GM,GC	0.4	70
				ML,CL		
		18-40	fsl,cl	SM,SC,ML,CL	0.4	70
		40-60	gl	ML,CL,GM,GC	0.3	53
Marksboro		0-10	l	ML,CL	0.24	42
			gl	ML,CL,SM,SC	0.24	42
		10-40	l,gsil	SM,SC	0.4	70
Menlo		0-22	l	ML,CL	0.24	42
			gl	ML,CL	0.24	42
		22-40	gl (pan)	SM,SC	0.5	88
Middlebury		0-10	fsl	SM,SC,M	0.24	42
		10-50	fsl,sil	SM,SC,ML	0.4	70
Minoa		0-30	sil,fsl	ML,CL,SC	0.28	49
		30-60	lfs,sil,lvfs	SM	0.2	35
Nassau		0-7	shsil,chsil,vsil	SM,GM	0.20	35
		7-16	chsil,vchsil	SM,SC,GM,GC	0.2	35
			shsil,vshsil			
		16+	shale bedrock			
Netcong		0-60	fsl,sl	SM,SC	0.24	42
Norwich		0-6	sil	ML,CL	0.32	56
			vstsil	ML,CL	0.28	49
		6-30	chsicl	ML,CL	0.3	53
		30-60	vchsil	ML,CL	0.3	53
Oquaga		0-16	vstsl,estl	SM	0.20	35
		16-26	stsl	SM	0.3	53

TABLE A1-2a EROSION PROPERTIES OF SOILS IN NEW JERSEY
LAND RESOURCE AREA 144, R= 175

Soil Series (Alpha Listing)	Local ⁱ Mapping No.	Typical Profile (inches)	USDA Texture Range	Unified System	K	KR
		26+	Bedrock			
Otisville		0-10	sl,gsl,gls	SM,SP-SM,GP-GM	0.17	30
		10-60	gls,gs	SM,SP-SM,GM	0.2	35
				GP-GM		
Palmyra		0-18	sil,gfsl	ML,CL	0.24	42
		18-24	sil	ML,CL	0.2	35
		24-40	g & s	SM	0.2	35
Parsippany		0-7	sil	ML,CL	0.43	75
		7-34	cl,sicl,sic	ML,CL,CH	0.4	70
		34-60	sicl,cl,l	ML,CL,CH	0.4	70
Paulina		0-21	l,shl	ML,CL	0.28	49
		21-38	shl	ML,CL	0.2	35
Phelps		0-21	fsl	SM	0.24	42
		21-45	sl	SM	0.3	53
		45-50	g & s	SM	0.2	35
Pompton		0-28	sl,fsl	SM	0.24	42
		28-60	s & g	SM,GM	0.2	35
Preakness		0-12	sl,l	SM	0.28	49
		12-30	sl	SM	0.2	35
		30-60	ls,sl	SM,SP-SM	0.2	35
Raynham			gls	GM,SP-SM	0.2	35
		0-28	sil	ML,CL	0.49	86
		28-60	sil,vfsl	ML,CL	0.4	70
Red Hook		0-10	fsl	SM,SC	0.24	42
		10-35	sil	ML,CL	0.4	70
		35-60	ls	SM	0.4	70
Rhinebeck		0-12	sil,sicl	ML,CL,OL	0.49	86
		12-30	sicl,sic	CL,ML	0.4	70
		30-40	sicl,sil,vfsl	CL,ML	0.5	88
Ridgebury		0-16	sl,fsl,l	SM,ML,SC	0.24	42
		16-40	gl,gsl	SM,SC	0.3	53
		40-60	gs,s	SM,GM	0.2	35
Riverhead		0-9	sl	SM,SC	0.28	49
			gsl	SM,SC	0.20	35
		9-34	fsl,slgsl	SM,SC	0.3	53
		34-60	ls,s,gls,gs	SP-SM,SM,GP-GM	0.2	35

TABLE A1-2a EROSION PROPERTIES OF SOILS IN NEW JERSEY
LAND RESOURCE AREA 144, R= 175

Soil Series (Alpha Listing)	Local ⁱ Mapping No.	Typical Profile (inches)	USDA Texture Range	Unified System	K	KR	
Rockaway		0-30	1	GM ML,SM,SC	0.24	42	
			gsl,gl,vstl, vstsl,estsl	ML,SM,SC	0.17	30	
			30-60	gsl	SM,SC	0.2	35
Rockport		0-10	shsil	ML,CL	0.20	35	
			10-36	sicl,sic	ML,CL,MH,CH	0.4	70
Roe		0-10	shsil	ML,CL	0.24	42	
			10-36	l,sil	ML,CL	0.3	53
			36-60	fs	SM	0.2	35
Scio		0-40	sil	ML,CL	0.49	86	
			40-60	sl	SM	0.3	53
Sloan		0-45	sil,sicl	ML,CL			
			45-60	gsl	SM		
Stephensburg		0-19	shl	ML	0.28	49	
			19-26	vshl	GM,SM	0.2	35
				shale bedrock			
Swartwood		0-30	gfsl,gls,vstsl,	SM,SC	0.17	30	
			30-60	gfsl (pan)	SM,SC	0.3	53
Townsbury		0-13	l	SM,ML	0.24	42	
			vstl	SM,ML	0.17	30	
			13-36	l	SM,ML,SC	0.4	70
			gl	SM,ML,SC	0.2	53	
			30-60	gsl	SM	0.2	35
Tunkhannock		0-18	gl,vgl	SM,GM,ML	0.17	30	
			18-32	vgsl	GM,SM	0.2	35
			32-60	s,gs	SM,GMSP.GP	0.2	35
Unadilla		0-10	vfsl	ML,CL	0.49	86	
			10-60	sil,vfsl	ML,CL	0.4	70
			60-70	g & s	SP-SM,GP-GM, GW-GM	0.3	53
Valois		0-60	shl	ML,CL	0.17	30	
Walkkill		0-8	sil	OL,CL,ML,SM,SC	0.32	56	
			8023	sil	CL,ML,SM,SC	0.4	70
			23-60	much & peak	OL,Pt	0.4	70

TABLE A1-2a EROSION PROPERTIES OF SOILS IN NEW JERSEY
LAND RESOURCE AREA 144, R= 175

Soil Series (Alpha Listing)	Local ⁱ Mapping No.	Typical Profile (inches)	USDA Texture Range	Unified System	K	KR
Washington		0-9	l,sil	ML,CL	0.32	56
			vstl	ML,CL	0.28	49
		9-60	l,sicl,cl	ML,CL	0.3	53
Wassaic		0-14	sil,l	ML,CL	0.32	56
			gl,gsil	SM,SC,GM,GC	0.24	42
		14-23	l,sl	SM,SC,ML,CL	0.3	53
			gsil	GM,GC	0.2	35
Wayland		23+	Bedrock			
		0-7	sil	OL-ML,CL	0.32	56
		7-38	sil	ML,CL	0.5	88
		38-50	stratified sil & fsl	ML,CL,SC,SM,GM GC	0.4	70
Wellsboro		0-11	sil,fsl,l	SM,ML,CL	0.28	49
			chsil	SM,ML,CL	0.20	35
		11-22	l,sil	ML,CL	0.3	53
		22-60	fsl,sil,gl (pan)	SM,SC,ML,CL	0.3	53
Whippany		0-9	sil	ML,CL	0.43	75
		9-60	sil,sicl,sic,c	ML,CL,CH	0.4	70
Whitman		0-10	fsl,sl,lvsl	OL,SM,ML	0.24	42
			vstl,estsl		0.24	42
		10-40	fsl,sl,l	SM,ML-CL	0.2	35
		40-60	gsil	SM		
Woodglen		0-10	l	ML,CL	0.49	86
		10-36	sicl,c	ML,CL,MH,CH	0.4	70
		36-60	l,cl	ML,CL	0.4	70
Wooster		0-32	l,sil,cl	ML,CL	0.32	56
			gl,chl,gsil	ML,CL	0.3	53
			chsil,gcl,chl			
		32-60	l,sil,chl,chsil gl,gsil	ML,CL,SM,SC	0.3	53
Wurtsboro		0-18	fsl	SM,SC	0.24	42
			gfsl	SM,SC	0.17	30
		18-60	fsl (pan)	SM,SC	0.3	53
			gfsl	SM,SC	0.2	35

TABLE A1-2b EROSION PROPERTIES OF SOILS IN NEW JERSEY
LAND RESOURCE AREA 148, R= 175

Soil Series (Alpha Listing)	Local ^{1/} Mapping No.	Typical Profile (inches)	USDA Texture Range	Unified System	K	KR
Abbottstown		0-20	sil	ML,CL	0.43	75
		20-38	sil (pan)	ML,CL	0.4	70
		38-48	shsil	ML,CL	0.4	70
			shl	SM,GM	0.3	53
Amwell		0-10	sil	ML,CL,SC	0.32	56
			gsil	ML,CL<SC	0.28	49
		10-23	sil,sicl,gsil	ML,CL	0.3	53
		23-41	gsicl,ksicl	ML,CL	0.3	53
			vgasil	GM,GC	-	-
		41-53	kfsl,gsil	ML,CL,GC	0.3	53
Annandale		0-10	l	ML,SM	0.28	49
			gl	SM	0.24	42
		10-32	l,cl,scl	ML,CL	0.4	70
			gl,gcl,gscl	ML,CL	0.3	53
		32-44	same as 7-32 inches with pan		0.5	88
		44-60	sl	SM,ML	0.3	53
Athol			gsl	SM,GM	0.2	35
		0-10	gl	SM	0.32	56
		10-38	sicl,cl	ML,CL	0.3	53
			gcl	SM,SC	0.3	53
		38-60	sicl,cl	ML,CL	0.3	53
			gsl,gl	SM,SC,GM,GC	0.3	53
Bartley		0-11	l,g	ML,CL	0.32	56
		11-32	cl,l,scl	ML,CL	0.3	53
		32-42	sl,l	SM,SC	0.2	35
		42-60	sl,l,gsl,gl	SM,SC	0.2	35
Beddington		0-9	shsil	ML,CL	0.32	56
		9-35	shsil,shl	ML,CL	0.2	35
			sil	ML,CL	0.3	53
		35-66	vshl,vshsil	ML	0.2	35
			shsil	CL	0.3	53
		66-72	wesh	GM	0.2	35
Berks		0-8	shsil,chsil	GM,GC,ML	0.24	42
		8-20	sh to vshsil	SM,GM,GC	0.2	35
		20-30	vshsil	GM,GC,SM	0.2	35

TABLE A1-2b EROSION PROPERTIES OF SOILS IN NEW JERSEY
LAND RESOURCE AREA 148, R= 175

Soil Series (Alpha Listing)	Local ^{1/} Mapping No.	Typical Profile (inches)	USDA Texture Range	Unified System	K	KR
Birdsboro		30+	shattered shale		0.2	35
		0-16	sil,l	ML,CL,SM	0.28	49
		16-48	sicl,cl	CL,ML,SM	0.3	53
		48-60	sl,s,g	GM,GC,SM,GW	0.2	35
Bowmansville			sicl,l	CL,ML	0.3	53
		0-8	sil	ML,CL	0.43	75
		8-32	sil,l,scl	ML,CL	0.4	70
		32-60	sil,scl,sl,	ML,CL	0.4	70
Bucks			s,g		0.3	53
		0-21	sil	ML,CL	0.32	56
		21-36	sicl,sil	ML,CL,MH	0.4	70
Califon		36-52	shsil,vshsil	ML,CL,GM,GC	0.2	35
		0-10	l	ML,SM	0.28	49
			gl,gsil,vstl	SM	0.24	42
Chalfont		10-32	l,cl,scl	ML,CL	0.4	70
			gl,gcl,gscl	ML,CL	0.3	53
		32-44	same as 10-32 but with pan		0.5	88
		44-60	sl	SM,ML	0.3	53
			gsil	SM,GM	0.2	35
		0-18	sil	ML,CL	0.43	75
Cokesbury			vstsil	ML,CL	0.37	65
		18-50	sil,sicl	ML,CL	0.6	105
		50-60	shsil,shl	ML,GM	0.6	105
		0-15	l	ML,CL,SM	0.32	56
			gl,vstl,estl	SM,SC	0.24	42
Croton		15-25	cl,sicl	ML,CL	0.4	70
		25-48	l,sl	ML,SM	0.5	88
		48-60	gl	SM,SC	0.4	70
		0-18	sil	ML,CL	0.43	75
			vstsil	ML,CL	0.37	65
Doylestown		18-36	sil,sicl	ML,CL,CH	0.5	88
		36-48	shsil,shsicl	ML,CL,SMSC	0.4	70
		48+	Shale bedrock			
		0-20	sil	ML,CL	0.43	75
	60-48	sil	ML,CL	0.6	105	
		shl	GM,GC	0.4	70	

TABLE A1-2b EROSION PROPERTIES OF SOILS IN NEW JERSEY
LAND RESOURCE AREA 148, R= 175

Soil Series (Alpha Listing)	Local ^{1/} Mapping No.	Typical Profile (inches)	USDA Texture Range	Unified System	K	KR
Duffield		0-10	sil	ML,CL	0.32	56
			vsil,vrsil	ML,CL	0.28	49
		10-36	sicl	ML,CL,MH,CH	0.3	53
		36-60	sicl	ML,CL	0.4	70
			shsil	ML,CL	0.3	53
Dunellen		0-15	l,sl	ML,SM	0.24	42
			gl,gsl	ML,SM	0.24	42
		15-38	l,sl	ML,SM	0.3	53
			gl,gsl	ML,SM	0.2	35
		38-60	s,gs	SM,SP-SM,GM	0.2	35
Edneyville		0-11	estl,gl,stl, vstl	ML,SM	0.24	42
		11-39	sl,l,scl	ML,SM,SC	0.4	70
			gsl,gl,gsc	ML,SM,SC	0.3	53
		39-65	gsl	SM,GM	0.2	35
	Hazleton		0-9	chl,vstl	SM,GM	0.24
		9-40	chl	SM,GM	0.20	35
		40-50	vchl	GM	0.20	35
Klinesville		0-13	shsil,shl, shsil,vshsil	GM,SM,SC,ML	0.20	35
		13-18	vshsil,vshsl Shale, Bedrock	GM,GP	0.2	35
Lamington		0-10	sil	ML,CL	0.43	75
		10-23	sil,sicl	ML,CL	0.4	70
		23-45	cl,sil,l	ML,CL	0.4	70
		45-60	s,sl,sil	SM,SP-SM,ML	0.3	53
Lansdale		0-14	l,sl	SM,SC,ML,CL	0.28	49
			chl,vstl	SM,SC,ML,CL	0.24	42
		14-30	scl,sl	SM,SC	0.3	53
			l	ML,CL	0.4	70
		30-45	chsil,gsl	ML,CL	0.3	53
	35-60	chsl,gsl,fsl	SM,SC	0.2	35	
Lansdowne		0-10	l,sil	ML,CL	0.43	75
		10-26	cl,sicl	CL,CH	0.4	70
		26-40	l,sicl	ML,CL	0.4	70
		40-60	shsicl	ML,CL	0.4	70

TABLE A1-2b EROSION PROPERTIES OF SOILS IN NEW JERSEY
LAND RESOURCE AREA 148, R= 175

Soil Series (Alpha Listing)	Local ^{1/} Mapping No.	Typical Profile (inches)	USDA Texture Range	Unified System	K	KR
Lawrenceville		0-28	sil	ML,CL	0.49	86
		28-60	sil	ML,CL	0.6	105
			sl,vfsl	SM,SC	0.6	105
Legore		0-8	gl	SM,GM	0.20	35
		8-24	cl	ML,MH,CL	0.3	53
			gcl,gl,gsicl	SM,SC	0.2	35
		24-66	l,sil,sicl	ML,CL	0.3	53
			gl,vgl,gcl	SM-SC	0.2	35
Lehigh		0-14	sil	ML,CL	0.43	75
			chsil,vstsil	ML,CL	0.37	65
		14-20	chsicl	ML,CL	0.4	70
		30-41	chsicl,vchsil	ML,CL,GM	0.3	53
		41+	Shale Bedrock			
Meckesville		0-10	gl	ML,CL	0.28	49
		10-31	cl,l,scl, sicl (g)	ML,CL,SC	0.4	70
		31-38	l	ML,CL	0.4	70
		38-60	l,scl,(g,k)	ML,CL,SM,SC	0.3	53
Mount Lucas		0-9	sil	ML,CL	0.32	56
			vstsil	ML,CL	0.28	49
		9-32	l,cl,scl,sicl	ML,CL	0.3	53
		32-60	l	ML	0.4	70
Neshaminy			sl	SM-SC	0.3	53
		0-14	sil	ML,CL	0.32	56
			vstsil,gsil	ML,CL	0.28	49
		14-54	l	ML	0.3	53
			scl,sl	SM,SC	0.3	53
Nixon		54+	Diabase Bedrock			
		0-12	sil,l,sl	ML,CL,SM	0.28	49
		12-45	sil,sicl,cl	ML,CL	0.4	70
		45-60	sl,sil,s	SM,ML	0.3	54
			gsil,gs	SM,ML	0.2	35
Norton		0-14	sil,l	ML	0.32	56
		14-63	sicl	ML,CL	0.4	70
		63-70	sil	ML	0.4	70
		vgl,shl	GM	0.3	53	

TABLE A1-2b EROSION PROPERTIES OF SOILS IN NEW JERSEY
LAND RESOURCE AREA 148, R= 175

Soil Series (Alpha Listing)	Local ^{1/} Mapping No.	Typical Profile (inches)	USDA Texture Range	Unified System	K	KR
Parker		0-40	vgl,vgsl,gsl,kl estsp	SM,GM,GP	0.17	30
		40-60	vstl,vstls, stsl,stls	GM	0.20	35
Parsippany		0-9	l,sicl,sil	ML	0.43	75
		9-50	sicl,cl	ML,CL	0.5	88
		50-60	sicl,cl	ML,CL,CH	0.4	70
Pattenburg		0-7	l,gl,vgl	ML,SM,GM	0.32	56
		7-30	vgl,l,cl,scl	ML,GM,SM,SC	0.3	53
		30-60	gl,vgl,gsl,vgsl	GM,SM	0.2	35
Penn		0-8	l	ML	0.32	56
			shsil	ML,CL	0.28	49
		8-30	sil	ML,CL	0.4	70
			shsil,sicl	SC-SM	0.3	53
Pope		30+	Shale Bedrock			
		0-12	fsl	SM	-	-
		12-46	fsl,l	SM,SC	-	-
		46-60	s,sl,gs,gsl, vgs,vgsl	SP-SM,SM,GP-GM GM	-	-
Quakertown		0-16	sil	ML	0.32	56
			chsil	ML	0.28	49
		16-32	sicl	ML,CL	0.3	53
		32-48	chsil,cl	ML,CL	0.3	53
		48+	Sandstone Bedrock			
Raritan		0-14	sil	ML,CL	0.43	75
		14-43	cl,sicl	ML,CL,CH	0.3	53
		43-60	stratified	SM,SC	0.2	35
			s,fsl	SP,SM	0.2	35
			c,sil,l	ML,CL,CH	0.3	53
			g	GM	0.3	53
Readington		0-12	sil	ML,CL	0.43	75
		12-40	sil,sicl	SM,SC,ML,CL	0.4	70
		40-50	sil	ML,CL	0.4	70
			v,sh,sil	GM	0.3	53
Reaville		50+	Shale Bedrock			
		0-13	sil	ML,CL	0.43	75

TABLE A1-2b EROSION PROPERTIES OF SOILS IN NEW JERSEY
LAND RESOURCE AREA 148, R= 175

Soil Series (Alpha Listing)	Local ^{1/} Mapping No.	Typical Profile (inches)	USDA Texture Range	Unified System	K	KR
			shsil	ML,CL	0.37	65
		13-23	shsil	ML,CL	0.3	53
				GM,GC	0.3	53
		23+	Shale and Silstone Bedrock			
Riverhead		0-9	sl	SM,SC	0.28	49
			gsl	SM,SC	0.20	35
		9-34	fsl,slgsl,gfsl	SM,SC	0.3	53
		34-60	ls,s,gls,gs	SP-SM,SM,GP-GM	0.2	35
				GM		
Rowland		0-44	sil,l	ML,CL	0.43	75
			sicl	SM,SC	0.4	70
		44-60	stratified	SM,GM	0.3	53
			s & g	SP,GM	0.2	35
			sil	ML	0.4	70
Tioga		0-9	fsl	ML,CL,SM	0.49	86
		9-24	sil,l,fsl	ML,CL,SM	0.4	70
		24-60	vgls	SM,GM	0.2	35
Turbotville		0-50	l,sil	ML,CL	0.43	75
		50-60	l,sl	ML,SM	0.3	53
Washington		0-9	l,sil	ML,CL	0.32	56
			vstsl	ML,CL	0.28	49
		9-60	l,sicl,cl	ML,CL	0.3	53
Watchung		0-9	sil	ML,CL	0.43	75
		9-46	c,cl,sicl	ML,CL,CH	0.4	70
		46-60	sil,sicl,l	ML,CL	0.4	70
Whippany		0-10	sil	ML,CL	0.43	75
		10-60	sic,c,sicl	ML,CL,CH,MH	0.5	88

TABLE A1-2c EROSION PROPERTIES OF SOILS IN NEW JERSEY
LAND RESOURCE AREA 149, R= 200

Soil Series (Alpha Listing)	Local ^{1/} Mapping No.	Typical Profile (inches)	USDA Texture Range	Unified System	K	KR
Adelphia		0-14	sl,fsl,l	ML,CL,SM,SC	0.32	64
		14-37	l,scl,fsl	SM,SC,ML,CL	0.4	80
		37-60	sl,ls	SM	0.2	40
Atsion		0-16	s,fs	SP,SP-SM	0.17	34
		16-60	s,ls	SP,SP-SM	0.2	40
Aura		0-13	sl,l	SM,ML,CL	0.43	86
			gl,gsl	SM,SC	0.32	60
			ls	SP-SM,SM	0.28	40
		13-59	scl	SM,SC	0.4	80
			gscl,gsl	GM,GC	0.3	60
		59-72	scl,sl	SM,SC	0.4	80
			gsl,gcl	SM,SC,GM,GC	0.3	60
Barclay		0-14	fsl,lfs	SM	0.49	98
		14-40	vfs,fsl	SM	0.4	80
		40-60	fs,lfs	SM,SP-SM	0.3	60
Bayboro		0-14	sl,l,sil	ML	0.37	74
		14-64	c,cl,sic	CH,CL,MH	0.2	40
Berryland		0-12	s,fs	SP,SP-SM	0.17	34
		12-72	s,ls,sl	SP,SP-SM	0.2	40
Bertie		0-14	sil,l	ML,CL	0.37	74
		14-40	sil,sicl,l	ML,CL	0.4	80
		40-60	stratified	SM,SC,ML	0.3	60
		sl,l,ls				

		gsl	SM	0.2	40
Bibb	0-28	sl to sicl	ML,CL,SM	0.32	64
	28-60	highly variable	SM,GM,CL	0.29	40
Chillum	0-28	sil	ML,CL	0.32	64
	28-60	gscl,gl	SM,SC	0.3	60
		gsl	GM	0.2	40
Colemantown	0-14	l	ML,CL,SM	0.43	86
	14-30	sc,scl	CL,CH,MH	0.4	80
	30-60	sl,cl,scl	SC,ML,CL	0.4	80
Collington	0-13	sl,fsl	SM,SC,ML	0.28	56
		ls	SM	0.20	40
	13-32	scl,cl,sl,l	SC,SM,ML,CL	0.4	80
	32-60	sl,ls	SM,SC	0.2	40
Colts Neck	0-14	sl	SM	0.28	56
		ls	SM	0.20	40
	14-34	scl,sl,l	SM,SC	0.4	80
	34-60	sl	SM	0.3	60
Donlonton	0-12	fsl	ML,CL,SM,SC	0.43	86
	12-40	sc,cl,sic	CH,CL,ML	0.4	80
	40-60	sc,sicl,cl,ls	SM,SC,ML,CL	0.3	60
Downer	0-16	sl	SM,SP-SM	0.28	56
		ls	SM	0.20	40
	16-30	sl	SM	0.3	60
	30-60	s,ls	SP,SP-SM	0.2	40
Dragson	0-14	fsl,sl,lfs	SM,SC,ML	0.28	56
	14-30	sl,scl	SM,SC,CL	0.3	60
	30-60	ls,lfs	SM	0.2	40
Elkton	0-10	sil,sl,l	ML,CL,SM	0.43	86

	10-36	sic,c	CH,CL,MH	0.4	80
	36-60	sic,sicl,scl,c	SC,SM,CL,CH,MH	0.4	80
Evesboro	0-60	ls,s,fs	SM,SP	0.17	34
Fallsington	0-14	sl,fsl,l	SM,SC,ML	0.28	56
	14-35	scl,sl	SM,SC,ML	0.3	60
	35-50	s,ls,sl	SM,SP-SM	0.2	40
Fort Mott	0-24	s,ls	SP-SM,SM	0.20	40
	24-40	sl	SM	0.3	60
	40-60	s	SP-SM,SM	0.2	40
Freehold	0-14	fsl,sl,l	SM,ML	0.28	56
		ls,lfs	SM	0.20	40
	14-32	sl,scl	SM,SC	0.4	80
	32-60	stratified	SM	0.2	40
		ls,fsl			
Freneau	0-60	sl,l	SM,ML	0.28	56
Galestown	0-60	ls,s	SM,SP	0.17	34
Hammonton	0-18	sl	SM	0.28	56
		ls	SP-SM,SM	0.20	40
	18-36	sl	SM	0.3	60
	36-60	s,ls,gs,gl	SP-SM,SM	0.2	40
Holmdel	0-14	fsl,sl,l,lfs	SM,ML	0.28	56
	14-36	sl,scl,l	SM,SC	0.4	80
	36-60	ls,sl	SM	0.2	40
Howell	0-14	fsl,l	SM,ML,CL	0.43	86
	14-35	cl,sicl	CL	0.4	80
	35-60	c,sic,sicl	MH,ML,CL	0.3	60
Keansburg	0-30	sl,fsl,l	SM,ML,SC	0.28	56
	30-60	sl,l	SM	0.3	60

Keyport	0-10	sil,l,fsl,sl	SM,ML	0.43	86
	10-44	c,sic,cl	CL,CH,MH	0.4	80
	44-72	sicl,sic	CL,ML,MH	0.4	80
Sandy Substratum ⁱⁱⁱ	44-72	scl,sl	SM,SC,ML,CL	0.3	60 <u>2/</u>
Klej	0-40	ls,fs	SM,SP-SM,SP	0.17	34
	40-60	ls,fs,lfs,sl	SM,SP-SM,SP	0.2	40
Kresson	0-10	l,sl,ls,fsl	ML,CL,SM,SP-SM	0.43	86
	10-45	sc,scl	ML,MH,CL,CH	0.4	80
	45-60	sl,l	SM,SC,ML,CL	0.3	60
Lakehurst	0-60	s,fs	SP,SP-SM	0.17	34
Lakeland	0-60	ls,lfs,s	SM,SP	0.17	34
Lenoir	0-10	sil,l,fsl	SM,ML	0.43	86
	10-60	sicl,c,sic,cl	CL,CH,ML,MH	0.4	80
Sandy Substratum ³	40-72	scl,sl	SM,SC,ML,CL	0.3	60 <u>2/</u>
Leon	0-16	s	SP,SP-SM	0.17	34
	16-60	s,ls	SP,SP-SM	0.2	40
Lenoir	0-10	l,sil	ML,CL	0.43	86
	10-40	c,sic,cl	CL,CH,MH	0.4	80
	40-60	cl,sicl	CL,MH,ML	0.4	80
Lincroft	0-60	ls,s	SM,SP-SM	0.17	34
Marlton	0-14	sl,fsl	SM,SC	0.43	86
	14-45	sc,scl	ML,CL,MH,CH	0.4	80
	45-60	sl,scl	SM,SC,CL,ML	0.4	80
Matapeake	0-16	sil,fsl,l	ML-SM,CL	0.32	64
	16-34	sil,sicl	ML,CL	0.4	80
	34-60	s,ls,sl,l	SM,SC,CL,ML	0.3	60
		gs			

Matawan	0-20	sl,ls,fsl	SM,SC	0.32	64
	20-60	cl,scl,sc,sl	CL,SC,SM	0.4	80
Mattapex	0-14	sil,l	ML,CL	0.37	74
	14-40	sicl,sil,cl	ML,CL	0.4	80
	40-60	sl,ls,s,l, gs	SM,SC,CL,ML	0.2	40
Matlock	0-10	1	ML,CL	0.43	86
	10-35	sc,scl	ML,CL,MH,CH	0.4	80
	35-60	sl,l	SM,SC,ML	0.3	60
Monmouth	0-11	fsl,l,ifs	SM,SC,ML,CL	0.43	86
	11-40	SC,SCL	CL,SC	0.4	80
	40-60	sl,scl,sc	SM,SC	0.3	60
Nixonton	0-14	fsl,ifs	SM	0.49	98
	14-40	vfsf,fsl	SM	0.4	80
	40-60	ifs,ls	SM,SP-SM	0.2	40
Osier	0-60	s,fs,ls,ifs	SM,SP-SM	0.17	34
Othello	0-14	sil,l,fsl,sicl	ML,CL	0.37	74
	14-34	sicl,sil	ML,CL	0.4	80
	34-60	sl,ls,scl	SM,SC,CL	0.3	60
Pasquotank	0-30	vfsf,fsl	ML,SM	0.49	98
	30-60	vfsf,sl,ls	ML,SM	0.2	40
Pemberton	0-24	s,ls	SM,SP-SM	0.20	40
	24-34	sl	SM,SC	0.2	40
	34-60	s,ls	SM,SP-SM	0.2	40
Plummer	0-46	s,fs,ls,ifs	SM,SP-SM	0.17	34
	46-60	sl,scl	SM,SC	0.30	60
Pocomoke	0-28	sl,l,fsl,ls ifs	SM,ML	0.28	56

	28-60	ls,s	SM,SP-SM	0.2	40
Portsmouth	0-26	sil	ML,CL	0.28	56
	26-60	fs,cos	SP,SP-SM	0.2	40
Rutlege	0-18	ls,lfs	SM,SP-SM	0.17	34
	18-60	s,fs,ls,lfs	SP-SM,SP,SM	0.2	40
St. Johns	0-12	s	SP,SP-SM	0.17	34
	12-72	s,ls,sl,gs	SP,SP-SM	0.2	40
Sassafras	0-14	fsl,l,sl	SM,ML	0.28	56
		ls,lfs	SM	0.20	40
		gsl	SM,SP	0.24	48
	14-36	scl,sl,l	SM,SC,CL,ML	0.3	60
	36-60	sl,ls,fsl	SM	0.2	40
		gsl,gls	SM,SP,SP-SM	--	--
Shrewsbury	0-14	sl,fsl,l	SM,ML	0.28	56
	14-30	scl,sl	SC,SM,CL	0.3	60
	30-60	s,ls,sl	SM,SP-SM	0.2	40
Tinton	0-24	s,ls	SM,SP-SM	0.20	40
	24-60	s,ls	SM,SC,SP-SM	0.20	40
Weeksville	0-14	fsl	ML,SM	0.49	98
	14-44	sil,fsl	ML,SM	0.4	80
	44-60	vfsl,fsl,scl	ML,CL,SM	0.4	80
Westphalia	0-14	fsl,lfs	SM,ML	0.49	98
	14-28	fsl,lfs,	SC,SM,ML	0.4	80
		vfsl			
	28-60	fs,lfs,fsl	SM,ML,SP-SM	0.3	60
Woodsmansie	0-17	s	SM,SP-SM	0.20	40
	17-30	sl	SM,SC	0.2	40
	30-60	s,ls,sl	SM,SP-SM	0.2	40

Woodstown	0-14	sl,fsl,l	SM,SC,ML	0.28	56
		ls	SM	0.20	40
	14-36	scl,l,sl	SM,CL,SC,ML	0.4	80
		36-60	s,ls,sl	SM,SP-SM	0.2
		gsl,gls	SM,SP-SM		

TABLE A1-3
VALUES OF THE TOPOGRAPHIC FACTOR "LS"

Length of Slope (L) Ft.	Percent Slope (S)																					
	0.2	0.3	0.4	0.5	1.0	2.0	3.0	4.0	5.0	6.0	8.0	10.0	12.0	14.0	16.0	18.0	20.0	25.0	30.0	40.0	50.0	60.0
20	.05	.05	.06	.06	.08	.12	.18	.21	.24	.30	.44	.61	.81	1.0	1.3	1.6	1.8	2.6	4	6	8	10
40	.06	.07	.07	.08	.10	.15	.22	.28	.34	.43	.63	.87	1.2	1.4	1.8	2.2	2.6	3.5	5	8	11	15
60	.07	.08	.08	.08	.11	.17	.25	.33	.41	.52	.77	1.0	1.4	1.8	2.2	2.6	3.0	4.5	6	10	14	18
80	.08	.08	.09	.09	.12	.19	.27	.37	.48	.60	.89	1.2	1.6	2.1	2.6	3.0	3.6	5.5	7	11	16	21
100	.08	.09	.09	.10	.13	.20	.29	.40	.54	.67	.99	1.4	1.8	2.4	2.9	3.5	4.2	6.0	8	13	18	23
110	.08	.09	.10	.10	.13	.21	.30	.42	.56	.71	1.0	1.5	2.0	2.5	3.0	3.7	4.5	6	9	14	19	25
120	.09	.09	.10	.10	.14	.21	.30	.43	.59	.74	1.0	1.6	2.1	2.6	3.3	4.0	4.6	7	9	14	20	26
130	.09	.09	.10	.11	.14	.22	.31	.44	.61	.77	1.2	1.6	2.2	2.8	3.4	4.1	4.9	7	9	15	20	27
140	.09	.10	.10	.11	.14	.22	.32	.46	.63	.80	1.2	1.7	2.3	2.9	3.6	4.3	5.1	7	10	15	21	29
150	.09	.10	.11	.11	.15	.23	.32	.47	.66	.82	1.2	1.8	2.4	3.0	3.7	4.5	5.3	8	10	16	23	30
160	.09	.10	.11	.11	.15	.23	.33	.48	.68	.85	1.2	1.9	2.5	3.1	3.9	4.7	5.5	8	10	17	24	31
180	.10	.10	.11	.12	.15	.24	.34	.51	.72	.90	1.4	1.9	2.6	3.3	4.1	5.0	6.0	9	12	18	26	33
200	.10	.11	.11	.12	.16	.25	.35	.53	.76	.95	1.4	2.1	2.8	3.6	4.4	5.3	6.3	9	12	19	27	35
300	.11	.12	.13	.14	.18	.28	.40	.62	.93	1.2	1.8	2.7	3.6	4.5	5.6	6.8	8	12	16	25	35	45
400	.12	.13	.14	.15	.20	.31	.44	.70	1.0	1.4	2.0	3.2	4.2	5.4	6.7	8.0	10	14	19	30	42	54
500	.13	.14	.15	.16	.21	.33	.47	.76	1.2	1.6	2.2	3.7	4.9	6.2	7.6	9.2	11	16	21	34	47	61
600	.14	.15	.16	.17	.22	.34	.49	.82	1.4	1.6	2.4	4.1	5.4	6.9	8.5	10.3	12	16	24	38	53	68
700	.15	.16	.17	.18	.23	.36	.52	.87	1.4	1.8	2.6	4.5	5.0	7.5	9.3	11.3	13	18	26	41	58	75
800	.15	.16	.17	.18	.24	.38	.54	.92	1.6	2.0	2.8	4.9	6.4	8.2	10.1	12.2	14	20	28	45	58	81
900	.16	.17	.18	.19	.25	.39	.56	.96	1.6	2.0	3.0	5.2	6.9	8.8	10.8	13.1	16	22	30	48	57	87
1000	.16	.18	.19	.20	.26	.40	.57	1.0	1.6	2.2	3.0	5.6	7.4	9.3	11.6	14.0	17	24	32	51	72	93

When the length of slope exceeds 400 feet and (or) percent of slope exceeds 24 percent, soil loss estimates are speculative as these values are beyond the range of research data.

Table A1-4

C Values and Slope-Length Limits for Various Mulches \1

<u>Type</u>	<u>T/ac</u>	<u>Slope %</u>	<u>C Value</u>	<u>Max Length</u>
1. No Mulch or Seeding	---	All	1.0	---
2. Straw or Hay tied	1.0	≤5	.20	200
		6-10	.20	100
	1.5	≤5	.12	300
		6-10	.12	150
2.0	2.0	≤5	.06	400
		6-10	.06	200
		11-15	.07	150
		16-20	.11	100
		21-25	.14	75
		26-33	.17	50
		34-50	.20	35
3. Crushed Stone (1/4"- 1 1/2")	135	≤15	.05	200
		16-20	.05	150
		21-33	.05	100
		34-50	.05	75
240	240	≤20	.02	300
		21-33	.02	200
		34-50	.02	150
4. Woodchips	7	≤15	.08	75
		16-20	.08	50
12	12	≤15	.05	150
		16-20	.05	100
		21-33	.05	75
25	25	≤15	.02	200
		16-20	.02	150
		21-33	.02	100
		34-50	.02	75

Table A1-4

C Values and Slope-Length Limits for Various Mulches \1

<u>Type</u>	<u>T/ac</u>	<u>C Value</u>	
		<u>Through First 6 Weeks of Growing</u>	<u>After 6 Weeks of Growth</u>
5. Temporary (grain or fast growing grass)	NONE	.70	.10
	Straw 1 T/ac	.20	.07
	Straw 1.5 T/ac	.12	.05
	Straw 2.0 T/ac	.06	.05
6. Permanent Seeding, 2nd Year		--	.01
7. Sod		.01	.01

\1 Based on research data and field experience; prepared at a workshop of personnel from USDA Agriculture Research Service, Soil Conservation Service and various Maryland State and local agencies

TABLE A1-5

PRACTICE FACTOR P_c FOR SURFACE CONDITION FOR CONSTRUCTION SITES

<u>SURFACE CONDITION WITH NO COVER</u>	<u>FACTOR P_c*</u>
Compact and smooth, scraped with bulldozer or scraper up and down hill	1.3
Same condition, except raked with bulldozer root rake up and down hill	1.2
Compact and smooth, scraped with bulldozer or scraper across the slope	1.2
Same condition, except raked with bulldozer root rake across the slope	0.9
Loose as a disced plow layer	1.0
Rough irregular surface equipment, tracks in all directions	0.9
Loose with rough surface greater than 12" depth	0.8
Loose with smooth surface greater than 12" depth	0.9

*Values based on estimates

TABLE A1-6
ADJUSTMENT FACTOR M FOR ESTIMATING MONTHLY AND PORTIONS OF ANNUAL SOIL LOSS
FOR NEW JERSEY

Starting Months	ENDING MONTHS											
	Jan	Feb	Mar	Apr	May	June	July	Aug	Sept	Oct	Nov	Dec
Jan	0	0.02	0.04	0.06	0.10	0.20	0.35	0.55	0.76	0.86	0.93	0.97
Feb	0.98	0	0.02	0.04	0.08	0.18	0.33	0.53	0.74	0.84	0.91	0.95
Mar	0.96	0.98	0	0.02	0.06	0.16	0.31	0.51	0.72	0.82	0.89	0.93
Apr	0.94	0.96	0.98	0	0.04	0.14	0.29	0.49	0.70	0.80	0.87	0.91
May	0.90	0.92	0.94	0.96	0	0.10	0.25	0.45	0.66	0.76	0.83	0.87
June	0.80	0.82	0.84	0.86	0.90	0	0.15	0.35	0.56	0.66	0.73	0.77
July	0.65	0.67	0.69	0.71	0.75	0.85	0	0.20	0.41	0.51	0.58	0.62
Aug	0.45	0.47	0.49	0.51	0.55	0.65	0.80	0	0.21	0.31	0.38	0.42
Sept	0.24	0.26	0.28	0.30	0.34	0.44	0.59	0.79	0	0.10	0.17	0.21
Oct	0.14	0.16	0.18	0.20	0.24	0.34	0.49	0.69	0.90	0	0.07	0.11
Nov	0.07	0.09	0.11	0.13	0.17	0.27	0.42	0.62	0.83	0.93	0	0.04
Dec	0.03	0.05	0.07	0.09	0.13	0.23	0.38	0.58	0.79	0.89	0.96	0

All dates in the table are as of the 1st of each month, read from left to right.
M=1.0 for one full year.

Example: Given $KR=70$. $(LS) = 1.2$ What is soil loss for month of July?

$$E_t = 70 \times 1.2 = 84.0 \text{ tons per acre per year.}$$

$$E_t \text{ for July} = 84 \times 0.2 = 17 \text{ tons per acre for July on the average}$$

What is the soil loss if construction begins on the first of May and sod is established on disturbed areas by September 1st?

$$E_t \text{ May to September} = 84 \times 0.66 = 55 \text{ tons per acre.}$$

TABLE A1-7

APPROXIMATE WEIGHTS OF SOILS IN LBS. PER CUBIC FT. AND CONVERSION FACTORS

<u>Soils</u>	<u>Volume Wt.</u> <u>lb./cu. ft.</u>	<u>Conversion Factors</u>		<u>Tons to</u> <u>Cu. Yds.</u>
		<u>Ac. Inches</u>	<u>Ac. Ft.</u>	
Sands and loamy sands	110	0.005	0.00042	0.67
Sandy loam	105	0.0052	0.00044	0.71
Fine sandy loam	100	0.0055	0.00046	0.74
Loam	90	0.0061	0.00051	0.82
Silt loam	85	0.0065	0.00054	0.87
Silty clay loam	80	0.0069	0.00057	0.93
Clay loam	75	0.0073	0.00061	0.99
Silty, sandy clay and clay	70	0.0079	0.00066	1.06
<hr/>				
Aerated Sediment	80*	0.0069	0.00057	0.93
Saturated Sediment	60*	0.0092	0.00077	1.24

*These are the approximate aerated and saturated weights to be used at damage sites. (Streams or reservoirs)

TABLE A1-8

FACTORS FOR MODIFYING THE SOIL LOSS EQUATION TO OBTAIN ESTIMATES BASED ON PROBABILITY AND SINGLE STORM SOIL LOSS

Probability		Single Storm	
One Year In	Factor	Exceeded Once In (Years)	Factor
2	0.9	1	0.2
5	1.25	2	0.3
20	1.70	5	0.4
		10	0.5
		20	0.7

Example: The average annual soil loss from a critical sediment source area was computed to be 100 tons per acre per year.

One year in 5 this loss could be: $100 \times 1.25 = 125$ tons per acre, or one year in 20 the loss could be: $100 \times 1.7 = 170$ tons per acre.

A single storm that may take place once in 10 years could cause a soil loss of $100 \times 0.5 = 50$ tons per acre. If the single storm is one that occurs once in 2 years, the loss might be: $100 \times 0.3 = 30$ tons per acre.

Notes:

-
- i. Mapping units may be inserted on the basis of the local county soil survey.
 - ii. Alluvial soil, unassigned.
 - iii. Data for sandy substratum.

APPENDIX A2

REQUIREMENTS, GUIDELINES AND PROCEDURES FOR
PREPARING AND IMPLEMENTING "STANDARDS FOR SOIL EROSION AND
SEDIMENT CONTROL IN NEW JERSEY"

An application for certification of a soil erosion and sediment control plan shall include the following items.

1. One copy of the complete subdivision, site plan or construction permit application, including key map as submitted to the municipality (Architectural drawings and building plans and specifications not required.) which includes the following:
 1. Location of present and proposed drains and culverts with their discharge capacities and velocities and support computations and identification of conditions below outlets.
 2. Delineation of any area subject to flooding from the 100-year storm in compliance with the Flood Plains Act (NJSA 58:16A) or applicable municipal zoning.
 3. Delineating of streams, wetlands, pursuant to NJSA 13:9B and other significant natural features within the project area.
 4. Soils and other natural resource information used. (Delineation of the project site on soil map is desirable utilizing the USDA Web Soil Survey.)
 5. Land cover and use of area adjacent to the land disturbance.
 6. All hydraulic and hydrologic data, describing existing and proposed watershed conditions and HEC HMS, HEC RAS, TR-55 and similar models, and other electronic input files, if used, of existing and proposed conditions and a completed copy of the Hydraulic and Hydrologic Data Base Summary Form, SSCC 251 HDF1.
2. Up to four copies of the soil erosion and sediment control plan* at the same scale as the site plan submitted to the municipality or other land use approval agency to include the following: (This information shall be detailed on the plat)
 1. Proposed sequence of development including duration of each phase in the sequence.
 2. Site grading plan showing delineation of land areas to be disturbed including proposed cut and fill areas together with existing and proposed profiles of these areas (an interim grading-erosion control plan may be required for large sites with extensive cuts and fills).
 3. Contours at a two foot (or smaller) interval, showing present and proposed ground elevation.
 4. Locations of all streams and existing and proposed drains and culverts.
 5. Stability analysis of areas below all points of stormwater discharge which demonstrates a stable condition will exist or there will be no degradation of the existing condition.
 6. Location and detail of all proposed erosion and sediment control structures including profiles, cross sections, appropriate notes, and supporting computations.
 7. Location and detail of all proposed nonstructural methods of soil stabilization including types and rates of lime, fertilizer, seed, and mulch to be applied.
 8. Location and detail of all soil restoration areas must be graphically denoted on the plan including appropriate notes, details and sequencing.
 9. Control measures for non-growing season stabilization of exposed areas where the establishment of vegetation is planned as the final control measure.
 10. For residential development - control measures to apply to dwelling construction on individual lots and notation that such control measures shall apply to subsequent owners if title is conveyed. This notation shall be shown on the final plat.
 11. Plans with a notation for maintenance of permanent soil erosion and sediment control measures and facilities during and after construction, also indicating who shall have responsibility for such maintenance.
3. Appropriate fees. (As adopted by the individual district.)
4. Additional items as may be required.

*Individual districts may require modifications in the above list.

Return to TOC



APPLICATION FOR SOIL EROSION AND SEDIMENT CONTROL PLAN CERTIFICATION

The enclosed soil erosion and sediment control plan and supporting information are submitted for certification pursuant to the Soil Erosion and Sediment Control Act, Chapter 251, P.L. 1975 as amended (NJSA 4:24-39 et. seq.) An application for certification of a soil erosion and sediment control plan shall include the items listed on the reverse side of this form.

Name of Project			Project Location: Municipality		
Project Street Address			Block	Lot	
Project Owner(s) Name			Email	Phone #	Fax #
Project Owner(s) Street Address (No P.O. Box Numbers)			City	State	Zip
Total Project Area (Acres)	Total Disturbed Area (Acres)	Total Soil Restoration Area (Acres)	No. Dwelling or other Units	Fee \$	
Plans Prepared by*			Email of plan preparer:	Phone #	Fax #
Street Address			City	State	Zip

* (Engineering related items of the Soil Erosion and Sediment Control Plan **MUST** be prepared by or under the direction of and be sealed by a Professional Engineer or Architect licensed in the State of New Jersey, in accordance with NJAC 13:27-6.1 et. seq.)

Agent Responsible During Construction			Email		
Street Address					
City	State	Zip	Phone	Fax #	

The applicant hereby certifies that all soil erosion and sediment control measures are designed in accordance with current **Standards for Soil Erosion and Sediment Control In New Jersey** and will be installed in accordance with those Standards and the plan as approved by the Soil Conservation District and agrees as follows:

1. To notify the District in writing at least 48 hours in advance of any land disturbance activity. Failure to provide such notification may result in additional inspection fees.
2. To notify the District upon completion of the Project (Note: No certificate of occupancy can be granted until a report of compliance is issued by the District.
3. To maintain a copy of the certified plan on the project site during construction.
4. To allow District agents to go upon project lands for inspection.
5. That any conveyance of this project or portion thereof prior to its completion will transfer full responsibility for compliance with the certified plan to any subsequent owners.
6. To comply with all terms and conditions of this application and certified plan including payment of all fees prescribed by the district fee schedule hereby incorporated by reference.

The applicant hereby acknowledges that structural measures contained in the Soil Erosion and Sediment Control Plan are reviewed for adequacy to reduce offsite soil erosion and sedimentation and not for adequacy of structural design. The applicant shall retain full responsibility for any damages which may result from any construction activity notwithstanding district certification of the subject soil erosion and sediment control plan. It is understood that approval of the plan submitted with this application shall be valid only for the duration of the initial project approval granted by the municipality. All municipal renewals of this project will require submission and approval by the district. In no case shall the approval extend beyond three- and one-half years at which time resubmission and certification will be required. Soil Erosion and Sediment Control Plan certification is limited to the controls specified in the plan. It is not authorization to engage in the proposed land use unless such use has been previously approved by the municipality or other controlling agency. It is further understood that all documents, site plans, design reports etc. submitted to the district shall be made available to the public (upon request) pursuant to the Open Public Records Act, N.J.S.A. 47:1A-1 et seq.

1. Applicant Certification* Signature _____ Date _____ Applicant Name (Print) _____	3. Plan determined complete: Signature of District Official _____ Date _____
2. Receipt of fee, plan and supporting documents is hereby acknowledged: Signature of District Official _____ Date _____	4. Plan certified, denied or other actions noted above. Special Remarks: Signature of District Official _____ Date _____

*If other than project owner, written authorization of owner must be attached.

SSCC251 7/17

Return to TOC

_____ **SOIL CONSERVATION DISTRICT**
ADDENDUM TO APPLICATION

APPLICATION BY CORPORATION, PARTNERSHIP OR ORGANIZATION

OWNERSHIP DISCLOSURE CERTIFICATION

_____ Soil Conservation District requests that all applicants submit a complete list of ownership for purposes of determining conflicts of interest between the applicant and the board of members or their professionals. Attach Rider if necessary.

Disclosure of owners of organization and property subject to application. Any organization making an application for development under this act shall list the names and addresses of all members, stockholders, or individual partners (collectively, “interest holders”), including any other organization holding at least a 10% ownership interest in the organization, and shall also identify the owner of the property subject to the application, including any organization holding at least a 10% ownership interest in the property.

Listing of names and addresses of interest holders of applicant and owner organization. If an organization owns an interest equivalent to 10% or more of another organization, subject to the disclosure requirements hereinabove described, that organization shall list the names and addresses of its interest holders holding 10% or greater interest in the organization.

Disclosure of all officers and trustees of a non-profit organization. A non -profit organization filing an application of development under this act shall list the names and addresses of all officers and trustees of the non-profit organization.

This disclosure requirement is continuing during the Certification period and transfer of ownership of more than 10% must be disclosed.

Organization or non-profit organization failing to disclose: fine. Any organization or non-profit organization failing to disclose in accordance with this certification may be subject to a fine of \$25.00 to \$3,000, which shall be recoverable in the name of the governmental entity in a court of record in the State in a summary manner pursuant to the “Penalty Enforcement Law” of 1999(N.J.S.A. 2A:58-10 et seq.)

Name and Address of Applicant:

(If Corporation, Name and Address of Registered Agent and Officers, Trustees):

Stockholders / Members / Partners:

I certify that the above statements made by me are true. I am aware that if any of the foregoing statements made by me are willfully false, I am subject to punishment.

Print Name of Authorized Signatory & Title

Date

Authorized Signature

Witness

New Jersey Department of Agriculture
Hydrologic Modeling Database – Data Entry Form

Project Site Details

Chpt. 251 Application Number: _____

Start Date (if known): _____

County: _____

Street Address: _____

Municipality: _____

Block: _____

Lot: _____

NJDEP Anderson Landuse Code (4 digits):

Landuse description: _____

Site Centroid Location (NJ State Plane Feet): ¹

 Northing: _____ Easting: _____

Project Contact Details

Applicant: _____

Address: _____

Phone: _____

Email: _____

Post Construction Operation & Maintenance:²

Party Name: _____

Address: _____

Phone: _____

Email: _____

Party type: _____

New Jersey Department of Agriculture
Hydrologic Modeling Database – Data Entry Form

Basin Details:³

Basin Centroid (NJ State Plane Feet):⁴

 Northing: _____ Easting: _____

Basin Type: _____

Construction: _____

Status phase:⁵ Design As-built

Dam Height: (ft) _____ top width: (ft) _____

Dam Classification: _____

Drainage Area(s) to Basin [note- include any bypass areas]⁶

Drainage Area Name	Drainage Area (acres)	Post-Development CN#	Percent Impervious	Time of Concentration (min)

Basin Outlet Structure(s)⁷

ID:

End of Pipe Location:⁸ Northing: _____ Easting: _____

Discharge Type ⁹ (weir, orifice, etc)	Dimensions (diameter, length)	Elevation (USGS)	Discharge Coefficient ¹⁰	Equation Used ¹¹

New Jersey Department of Agriculture
Hydrologic Modeling Database – Data Entry Form

Basin Outlet Structure(s)

ID:

End of Pipe Location: Northing:

Easting:

Discharge Type (weir, orifice, etc)	Dimensions (diameter, length)	Elevation (USGS)	Discharge Coefficient	Equation Used

Basin Stage-Discharge Rating Table¹²

Elevation (USGS Feet)	Storage (Acre-Ft)	Total Outlet Structure Discharge (cfs)

NJDEP BMP Water Quality Structures¹³

Type (rain garden, green roof, seepage pit etc)	Size	Size Units (cu ft, sq ft etc)	Northing (SPF)	Easting (SPF)

New Jersey Department of Agriculture
Hydrologic Modeling Database – Data Entry Form

Explanatory Notes-

¹ Approximate location of center of site, coordinates in state plane feet

² Indicate who will be responsible for permanent operation and maintenance

³ Additional Basin Detail Pages can be used for more than one basin in a project.

⁴ Approximate location of center of basin, coordinates in state plane feet

⁵ Indicate “design” for basins not yet constructed

⁶ Drainage areas which are modified by construction, but not directed to the basin should still be listed and described

⁷ “Outlet structure” means the control box, outlet headwall, FES etc. This does not refer to an individual control on the structure such as a weir or orifice. There are two tables for more than one outlet structure

⁸ Approximate location of terminal discharge end of basin outfall, coordinates in state plane feet

⁹ Indicate the type of outlet – weir, orifice, hydro brake, etc.

¹⁰ Discharge Coefficient specific to the type of outlet control i.e., 0.6 for circular orifice

¹¹ List the discharge equation for each outlet (weir, orifice etc) used

¹² For basins with dead storage below the primary outlet, indicate 0 cfs discharge until the lowest outlet is reached. Routing table should begin at the lowest basin elevation.

¹³ Describe NJDEP BMP Manual water quality devices such as seepage pits, rain gardens etc. Size is appropriate for device – cubic feet, square feet or linear feet. Location of device using state plane feet coordinates.

APPENDIX A3

GUIDE FOR CONSTRUCTION SPECIFICATIONS

The following are examples of requirements that may be used for preparing construction specifications. Incorporation of such requirements will help assure protection of disturbed areas especially where critical soil erosion problems may exist.

The contractor shall perform all work, furnish all materials and install all measures required to reasonably control soil erosion resulting from construction operations and minimize loss of sediment from the construction site. The contractor shall adhere to the certified soil erosion and sediment control plan showing the methods to be used for controlling erosion during construction which includes sequence of construction operations. When no work will be performed on critical areas for more than 14 days, they shall be protected by temporary seeding, mulching, or sodding, or the slope lengths shall be reduced by the installation of diversions or other means.

The contractor shall install erosion controls on all disturbed critical areas or disturbances adjacent to critical areas.

Critical areas are any area subject to excessive erosion due to highly erodible soils, slope length, steepness, water concentration or other factors. Areas may become critical when the vegetation or other soil surface protection is removed.

The permanent vegetative cover such as seeding or sodding on all areas shall be accomplished within 10 days after final grading operations have been completed. Time extensions beyond the 10 day requirement may be requested in writing and are subject to written approval.

Exposed soil having a pH value of less than 4 shall be treated in accordance with the standard for Management of Highly Acid Soil, pg. 1-1.

Excavated soil material shall not be placed adjacent to rivers, streams or bodies of water in a manner that will cause it to be washed away by high water or runoff. Excess borrow material removed from the construction site shall be stabilized at the site of placement.

The contractor shall comply with applicable State and local regulations for prevention and abatement of pollution.

APPENDIX A4

MAINTENANCE OF EROSION CONTROL MEASURES

Maintenance is the work required to keep practices in, or restore them to, their original physical and functional condition.

Maintenance as it applies to this section is divided into two periods; that which is necessary to allow for continuing performance of erosion controls during the construction period and long term maintenance, following completion of construction, for the life of structural measures.

Maintenance During Construction Phase

All structural measures for control of soil erosion and sedimentation must have timely maintenance if the measures are to endure and efficiently perform their design function. Particular attention should be given to temporary structures.

Sediment barriers such as silt fence and haybales can accumulate large quantities of sediment, particularly after a heavy storm. The same is true for stormsewer inlet protection, which should be frequently inspected for blockage.

Construction entrances composed of loose aggregate may become impacted with sediments scoured from the tires of construction vehicles. When soil begins to track onto paved surfaces, the aggregate must be replaced or new aggregate added on top of the old.

Maintenance Following Completion of Construction

At the completion of construction and final stabilization responsibility for lifetime maintenance of structural measures is usually transferred to a subsequent owner such as the homeowner, municipality, homeowner association, etc. A comprehensive maintenance program should be prescribed for use of those who will accept such responsibility. All structures should be inspected at least semiannually and following intensive rainfalls.

Maintenance items should include but not be limited to those shown for each of the following examples.

Channel Linings (include slope protection structures)

Check for: Cracking; spalling; deterioration from freezing, salt or chemicals; channel obstructions; scour at inlet and outlet.

Corrective Action: cracks should be sealed, protective coatings applied when needed, and modification or riprap repairs made where and when necessary.

Earth Channels (Including diversions and waterways)

Check for: points of scour or bank failure and deposition; rubbish or channel obstruction; rodent holes; excessive wear from play, traffic or settling.

Corrective Action: remove sediment deposition and undesirable plant growth such as woody vegetation, weeds, etc. Repair damages from scour, rodents and loss of freeboard.

Dams and Spillways

Check fills for cracks, damage from wave action, rodents, undesirable vegetation growth, and obstructions to principal and emergency spillways. Check gates, trash racks, metal work, anchors, conduits and appurtenances for damage from corrosion, ice and debris. Check for unauthorized modifications, tampering or vandalism.

Corrective Action: fill and reseed eroded areas or riprap, removal of obstructions should be performed on a timely basis. Valves and gates should be cleaned, lubricated and operated through their full range.

Maintenance and inspection of dam and outlet structures may be subject to the requirements of the New Jersey State Dam Safety Standards, NJAC 7:20.

Water Quality Practices: Various structures and practices are designed to treat stormwater runoff by filtering in some manner. Practices such as sand filters and vegetative filter strips can become clogged with debris and sediment and will lose their ability to treat runoff. Periodic inspection and cleaning is needed to maintain filtration capacity. Other types of treatment practices rely on settlement of suspended solids, such as on-line stormsewer devices and wet or extended detention ponds. Over time, debris and sediment may accumulate in these devices and reduce the available volume needed to treat runoff. Periodic inspection and removal of debris is needed to maintain functioning.

Vegetative Maintenance: Vegetation is used as both a temporary and permanent erosion control practice. During establishment it is highly susceptible to damage both from natural and man-made causes. See the Standard for Maintaining Vegetation, pg. 3-1 for complete requirements.

APPENDIX A5

GUIDE FOR INSTALLING SOIL STABILIZATION MATTING

Soil stabilization matting is used as a mechanical aid to protect the soil from erosion during the critical period of vegetative establishment. It has the tensile strength and weight to resist water flow and erosion. Matting materials may be synthetic or natural (or a combination of the two), and may be permanent or bio/photo degradable over time. Matting may serve to provide a mulch-like cover to enhance germination in areas where straw, hay or other similarly applied mulch materials may not stay in place. Matting may also serve as a root anchor substrate to facilitate vegetation establishment where flowing water conditions may be encountered.

Materials

Matting is manufactured from a variety of materials including plastics, paper and natural fibers such as coir (coconut shell husks), wood shavings and jute. Matting is often constructed by using various combinations of materials such as natural fibers for germination bonded with man made materials for durability and anchoring. The material selected should be adequate to handle the expected environmental, engineering and agronomic stresses. For the purposes of implementing the various Standards which incorporate the use of stabilization matting materials, the evaluation and ratings provided by the Texas Department of Transportation (TDOT) have been adopted for use in the New Jersey Standards for Soil Erosion and Sediment Control. The TDOT hydraulics laboratory tests and rates matting materials for use in channel lining and general slope protection applications. Materials are evaluated for shear stress, soil loss and vegetative establishment.

General Installation Requirements

Site Preparation: Shape and grade the waterway, channel or area to be protected are required by job plans and specifications, including topsoiling. Remove rocks, clods over 1 ½ inches in diameter, sticks and other material that will prevent contact of the matting with the soil surface.

Seeding: Lime, fertilizer and seed in accordance with the applicable seeding standard.

Do not cultipack.

Laying the Matting: (See Figure A5-1 for general installation guidelines.) The following guidelines may be used for general purpose installation. However, manufacturer's installation instructions must be followed when special materials or techniques are required:

When the matting width is narrower than the channel width, start laying the matting from the top of the channel or slope and unroll downgrade so that one edge of the matting coincides with the channel center. Lay a second strip parallel to the first on the other side of the channel and allow at least a 2-inch overlap. Where one roll of matting ends and another roll begins, the end of the top strip overlaps the trench where the upper end of the lower strip is buried. Overlap the matting at least 4 inches and staple securely. Rolls of wood-shaving matting may be butted at the ends and securely stapled.

Securing the Matting: Bury the top of the matting in a trench 4 inches or more deep. Tamp the trench full of soil. Reinforce with a row of staples driven through the matting about 4 inches downhill from the trench approximately 10 inches apart. Then staple the overlap in the channel center. These staples should be 3 to 4 feet apart. The outside edges may be stapled similarly at any time after the center has been stapled. Closer stapling along the sides

is required where concentrated water may flow into the channel. The edges of wood-shaving matting should be stapled on 12 to 24 centers. Succeeding strips of matting, farther down the channel or slope, are secured in a similar manner.

Erosion Stops: At any point, matting may be folded for burying in slit trenches and secured as were the upper ends. This checks water flow and erosion that may begin under the matting. It also gives improved tie-down. The procedure is recommended on the steeper slopes of sandy soil and gentler slopes subject to seepage. Spacings vary from 25 to 100 feet.

Diversions: Where diversions outlet into the waterway, the outlet should be protected with matting used in the same manner as in the main channel. The matting for the outlet is laid first so that matting in the main channel will overlap the outlet strip.

Matting Soil Contact: Ensure contact between matting and soil by rolling after laying, stapling and seeding are complete. Perfect contact is vital to keep water flowing over - not under - the matting.

Inspection: After job completion, make sure the matting is in contact with the soil at all places and that critical areas are securely stapled down.

Figure A5-1: Typical Installation Detail Using Jute Matting

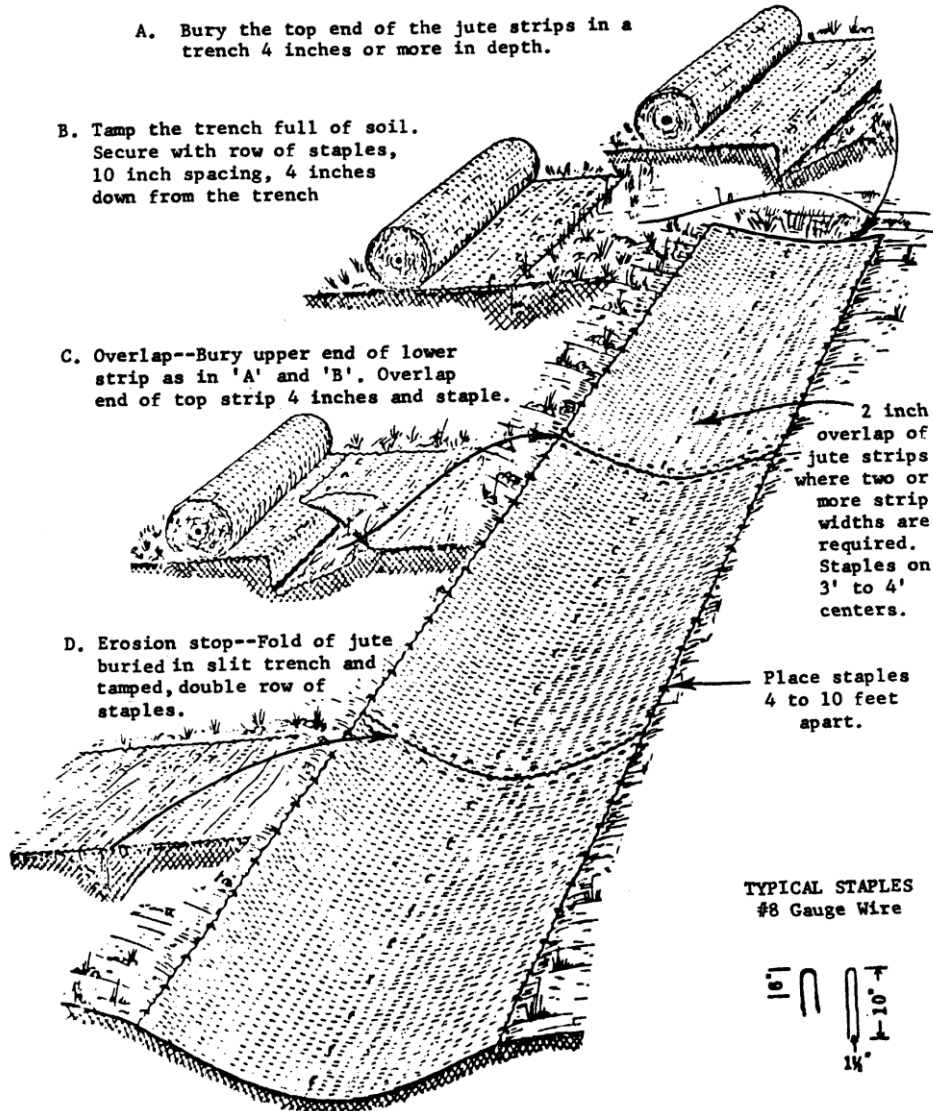

APPENDIX A6

DIVERSION AND GRASSED WATERWAY
EXAMPLE DESIGN PROBLEMS AND CHARTS

Diversion Example Problem:

A permanent diversion is to be constructed upslope of a house to divert runoff away from the house, and to protect it from surface water flooding. The diversion will outlet into a grassed waterway. The area upslope of the diversion is in woods which will be preserved. The diversion will be constructed on Rockaway gravelly sandy loam and will be seeded to a lawn grass mixture. It will be a part of the backyard of the house and is expected to be mowed. It will have a grade of 1 percent.

Solution:

The required capacity is the runoff from a 50 year storm. The required freeboard is 0.5 feet from page 15-2, the Standard for Diversions. Using the procedure in "Urban Hydrology for Small Watersheds, TR55," it was determined that the 50 year peak runoff rate from the watershed draining into the diversion is 20 cfs.

The grass will provide protection of the soil bed, thereby checking the erosion on the diversion. In comparison to a non-vegetated diversion, a grassed diversion will retard the flow of water. Manning's coefficient of roughness for a grassed diversion is related to the retardance. Retardance varies with the product of the mean velocity of flow and the hydraulic radius. The classification for the degree of retardance is based on the type of vegetation and condition of growth.

The maximum permissible velocity from page 15-5 for a clay loam soil with vegetation in the channel is 3.0 feet per second (for purposes of this example, a flexible channel liner will not be used). In a back yard, vegetation in the diversion channel can be expected to be maintained.

The appropriate vegetative retardance factors are E & D. The height of the grass will range between 6 inches and less than 2 inches. Select side slopes of 5 to 1 for the channel and ridge so that the diversion can be mowed with a lawn mower. Failure to maintain the grass by periodic maintenance results in weeds and destruction of the grass cover leaving the channel bare in the winter.

During the period of establishing the grass, the diversion will gradually be stabilized under a condition of very low retardance. The diversion will not reach its maximum capacity until the grass cover is fully developed and well established. Therefore, the hydraulic design of a grassed diversion consists of two stages.

The first stage is to design the cross-section of the diversion for stability under very low retardance (E). Stability of the diversion is based on allowable velocity for the soil type as shown on page 15-5

The second stage is to design the diversion for capacity under a higher retardance (D). The design of the cross-section of the diversion is now based on the capacity of the diversion to take the design flow (Q).

We now have:

- Grade of diversion = 1%
- Design Capacity (Q) = 20 cfs
- Maximum allowable velocity = 3.0 fps
- Vegetative retardance factors = E and D
- Channel side slopes = 5 to 1

First, design for stability using retardance factor E. Enter Figure A6-4 with 3.0 fps and slope = 1.0%, find the maximum allowable $R = 0.53$.

The cross sectional flow area required is $Q/V = 20/3 = 6.7$ sq. ft.

Enter Figure A6-6 with $A = 6.7$ and $R = 0.53$, find bottom width equal 5 feet and depth equal 0.8 feet.

Second, design for capacity using retardance factor D. A trial and error procedure is necessary for a trapezoidal channel with 5:1 side slopes and 20 foot bottom width on a 1% grade with D retardance.

Trial #1

Try $d = 1.0$ feet, enter Figure A6-6

find $R = 0.62$

$A = 9$ enter Figure A6-3

find $V = 2$

$Q = VA = (2)(9) = 18$ cfs

required 20 cfs capacity is larger.

Trial #2

Try $d = 1.2$ feet, repeat steps in 1st trial

find $R = 0.76$

$A = 13$

$V = 2.8$

$Q = 36.4$ cfs is larger than required.

Trial #3

Try $d = 0.96$ feet,

find $R = 0.64$

$A = 9.4$

$V = 2.13$

$Q = 20$ cfs

Design Flow Dimensions:

- a. Grade = 1%
- b. Side slopes = 5:1
- c. Bottom width = 5 feet
- d. Depth = 1.1 feet (required flow depth)

Constructed Diversion Dimensions:

- a. Grade = 1%
- b. Side slopes of channel is 5:1 both sides, back slope of ridge is 5:1 and, for maintenance reasons, ridge top width is 4 feet from the standard.
- c. Bottom width of the channel is 5 feet
- d. Depth from bottom of the channel to top of ridge is: 0.96 feet

for flow depth plus 0.50 feet for freeboard plus 0.1 feet for settlement equals a constructed depth of 1.56 feet.

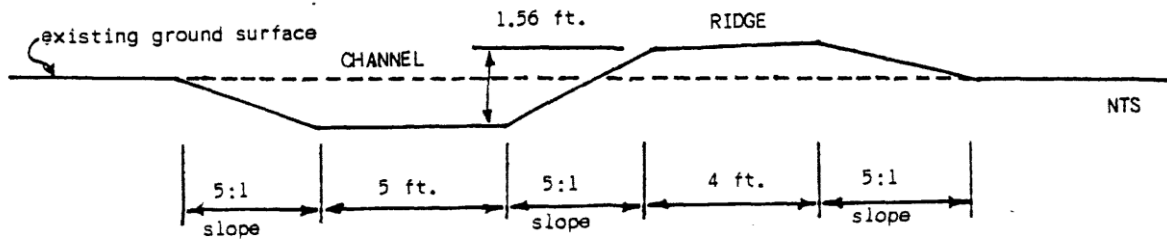

Waterway Example Problem:

A waterway is to be constructed to convey water through an apartment complex. It will be located in an area where the grass will be mowed at least once a year and needed fertilization and repairs will be made on an annual basis. From the soil survey report, the waterway will be constructed on Reaville silt loam. The waterway will have a grade of 0.5%. The peak flow from a 10 year frequency storm is 40 cfs.

Waterway Example Problem Solution:

The maximum permissible velocity from page 18-2 for a silt loam with a good stand of vegetation is 2.0 feet per second. The appropriate retardance factors are E and D, since during the year the height of the grass will vary between 2 inches immediately after cutting and 10 inches when it has not been cut. A good stand of vegetation will be maintained by annual fertilization and maintenance. Select a parabolic shape for the waterway to keep low flows from meandering and to provide a shape which is easy to mow and traverse with equipment.

We now have:

- Grade of the Waterway = 0.5%
- Design Capacity = 40 cfs
- Maximum allowable velocity = 2.0 fps
- Vegetative Retardance factors = E and D
- Channel Shape = parabolic

First, design for stability using the retardance factor E. Enter Figure A6-4 with $V = 2.0$ fps and slope = 0.5%, find maximum allowable $R = 0.57$. The cross sectional flow area required is $Q/V = 40/2 = 20$ sq ft. Enter Figure A6-14 with $A = 20.0$ and $R = 0.57$, find top width (t) = 35.7 feet and depth (d) = 0.84 feet

Second, design for capacity using retardance factor D. A trial and error procedure is necessary for a parabolic channel with the channel shape determined by $d = 0.84$ feet and $t = 35.7$ feet. Enter Figure A6-15 and find a point on the pivot line. This point remains fixed for this channel.

After several iterations:

Try $d = 1.06$ feet for retardance factor D. From Figure A6-15 using the fixed point on the pivot line for this channel and $d = 1.06$ feet, find $t = 40$ feet. From Figure A6-14 find $R = 0.70$ and $A = 28.2$. Enter Figure A6-3 with $R = 0.70$ and $S = 0.5\%$ and find $V = 1.42$ fps. Then $Q = VA = (1.42)(28.2) = 40$ cfs.

This meets the required Q of 40 cfs, therefore use these dimensions. The design channel dimensions are: Grade = 0.5% and Parabolic shape with a depth (d) = 1.06 feet and top width (t) = 40 feet.

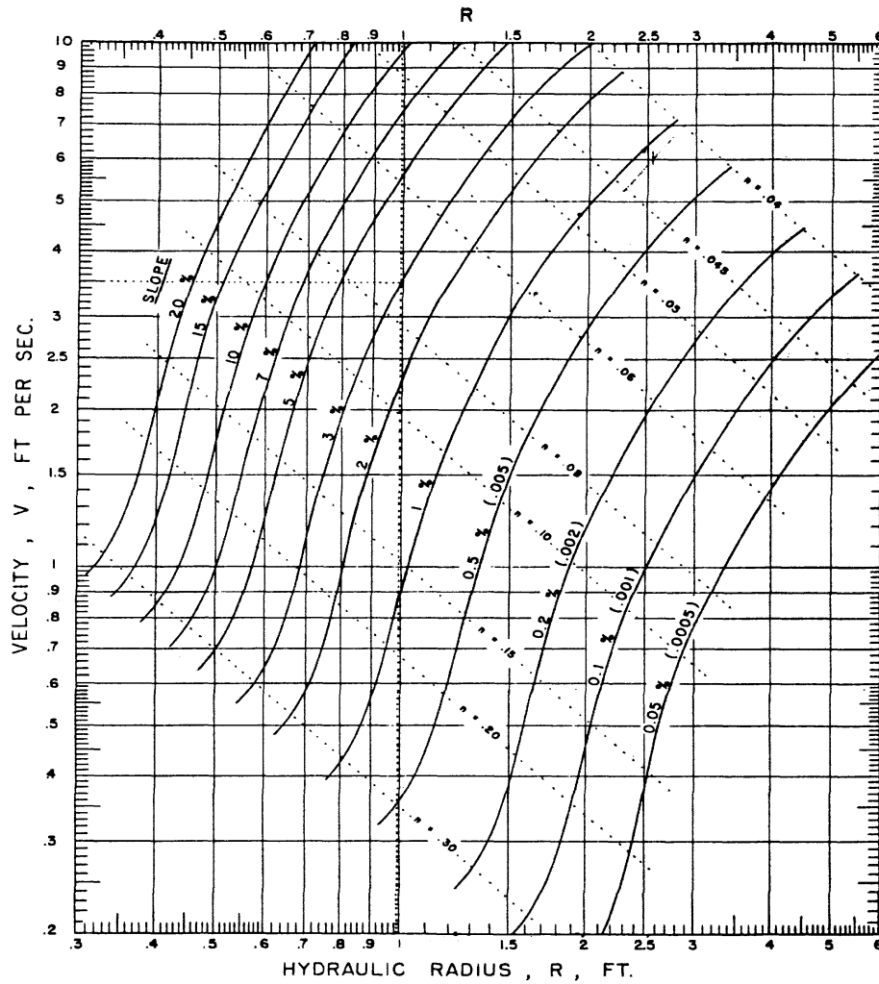

FIGURE A6-1

SOLUTION OF THE MANNING FORMULA FOR RETARDANCE B (HIGH VEGETAL RETARDANCE)

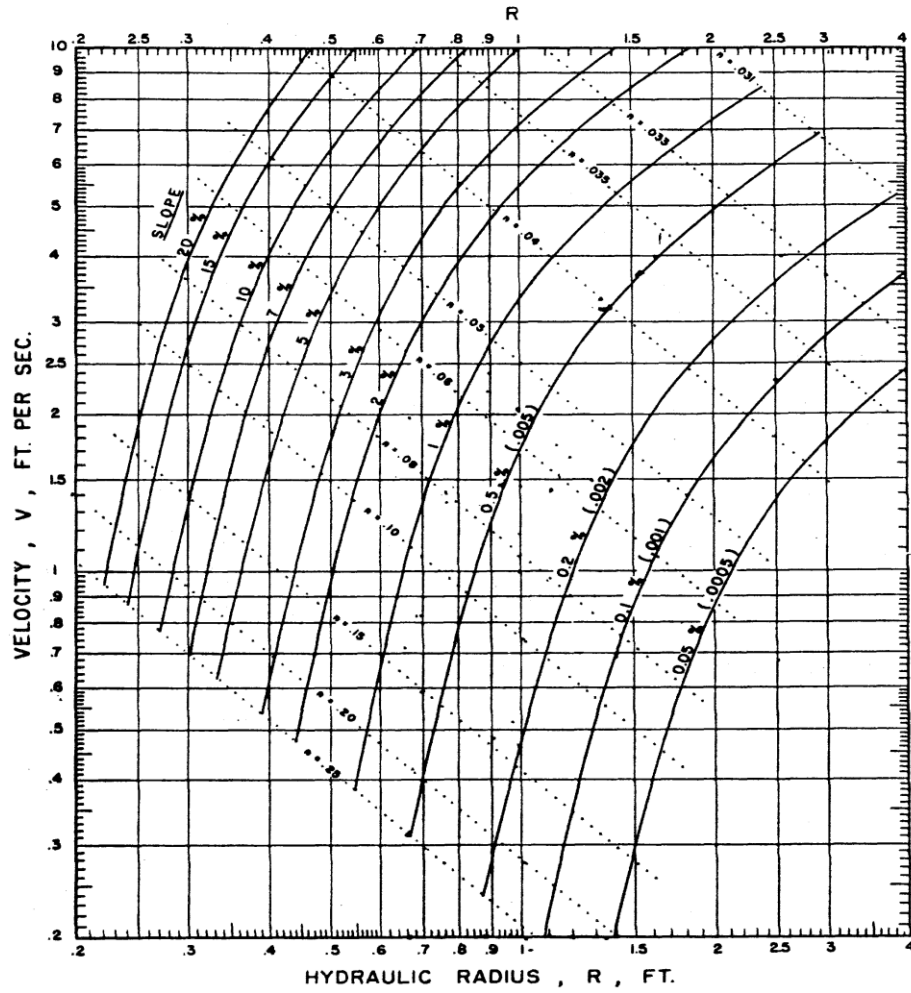

FIGURE A6-2

SOLUTION OF THE MANNING FORMULA FOR RETARDANCE C (MODERATE VEGETAL RETARDANCE)

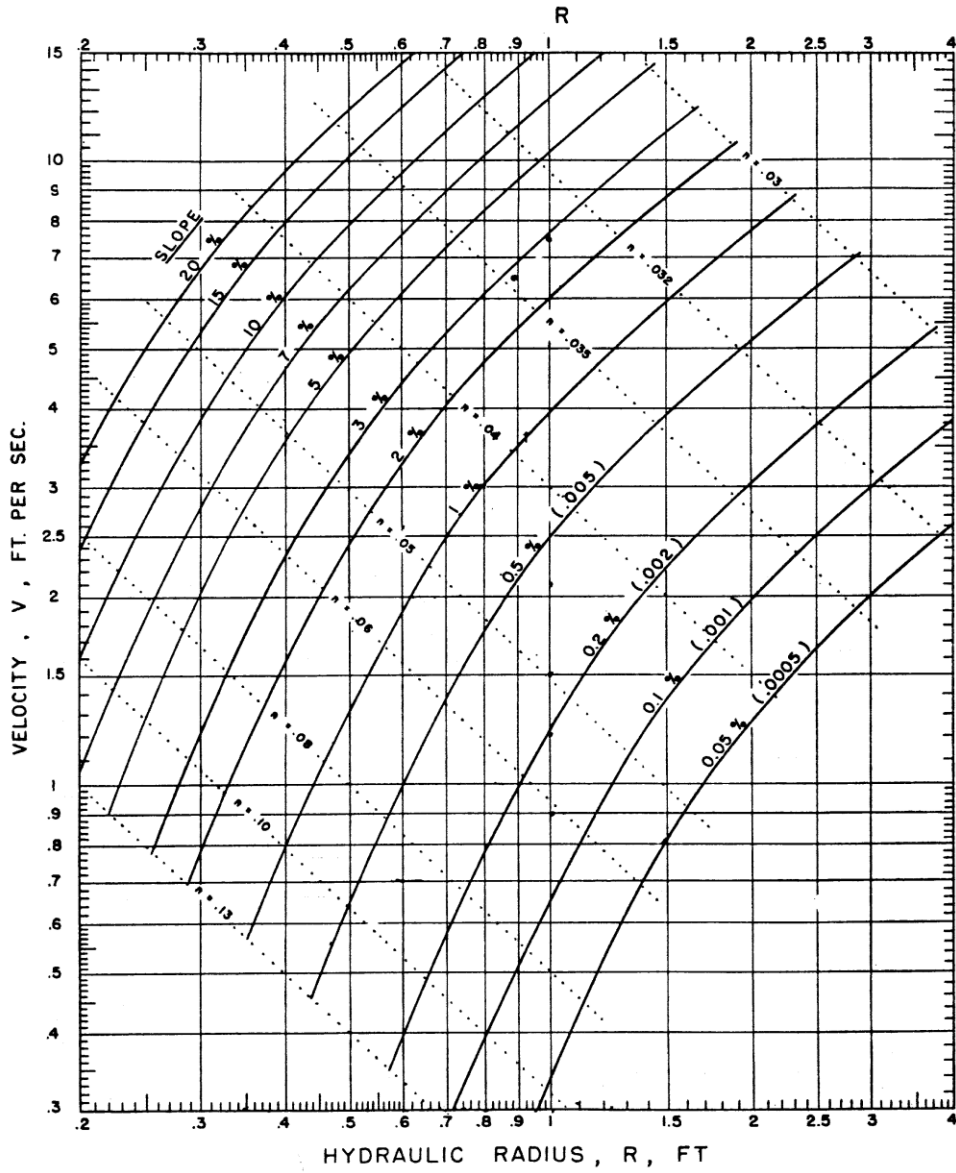

FIGURE A6-3

SOLUTION OF THE MANNING FORMULA FOR RETARDANCE D (LOW VEGETAL RETARDANCE)

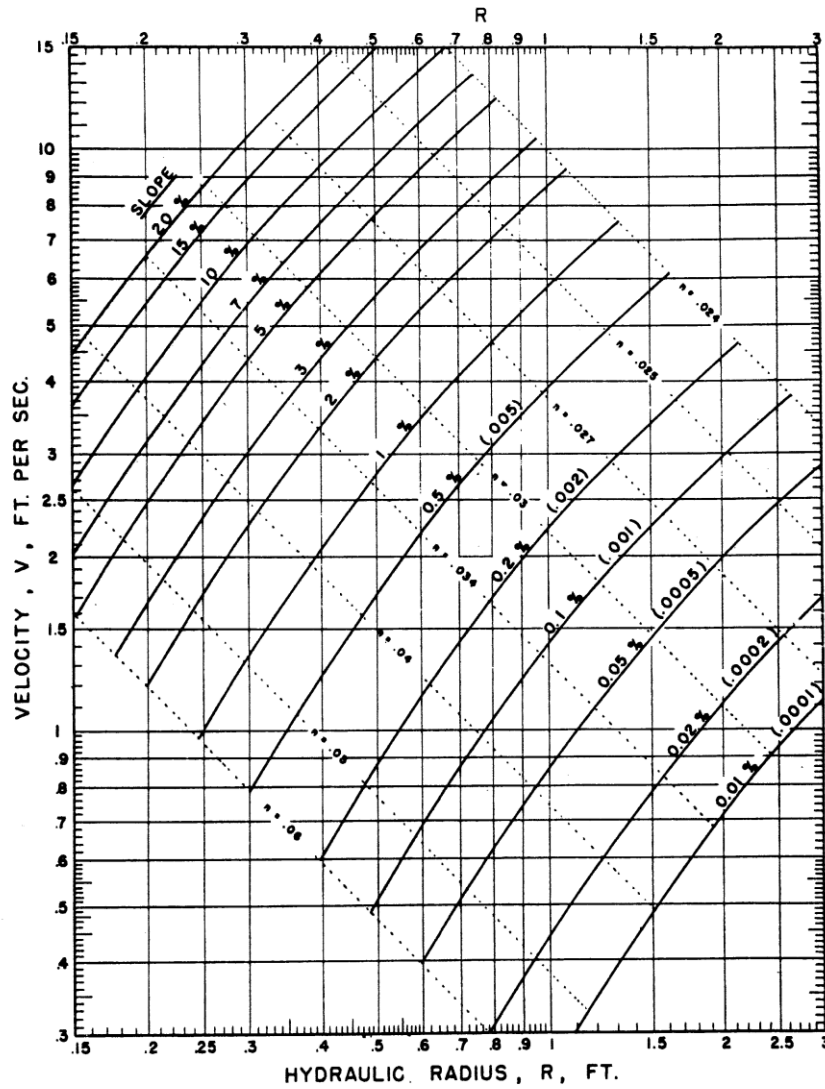

FIGURE A6-4

SOLUTION OF THE MANNING FORMULA FOR RETARDANCE E (VERY LOW VEGETAL RETARDANCE)

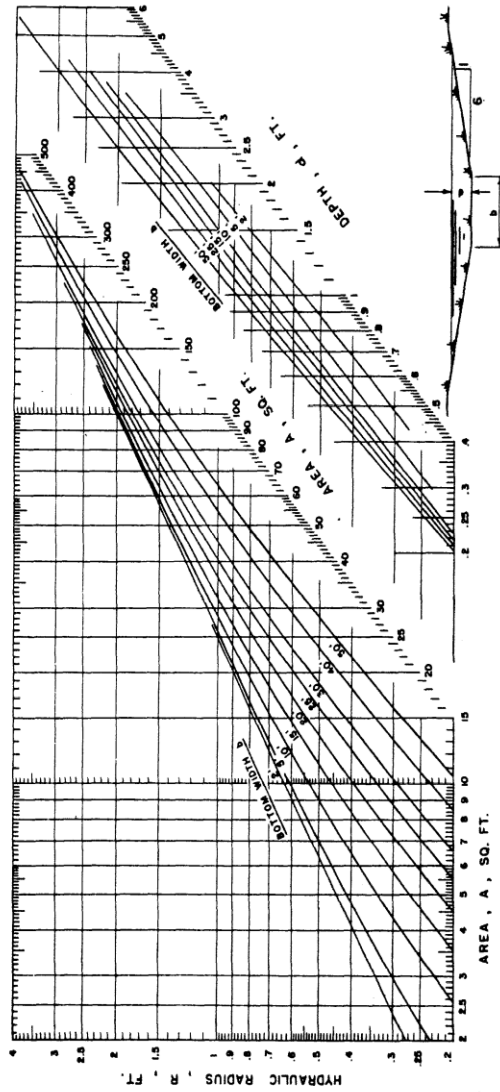

FIGURE A6-5
DIMENSIONS OF TRAPEZOIDAL CHANNELS WITH 6 TO 1 SIDE SLOPES

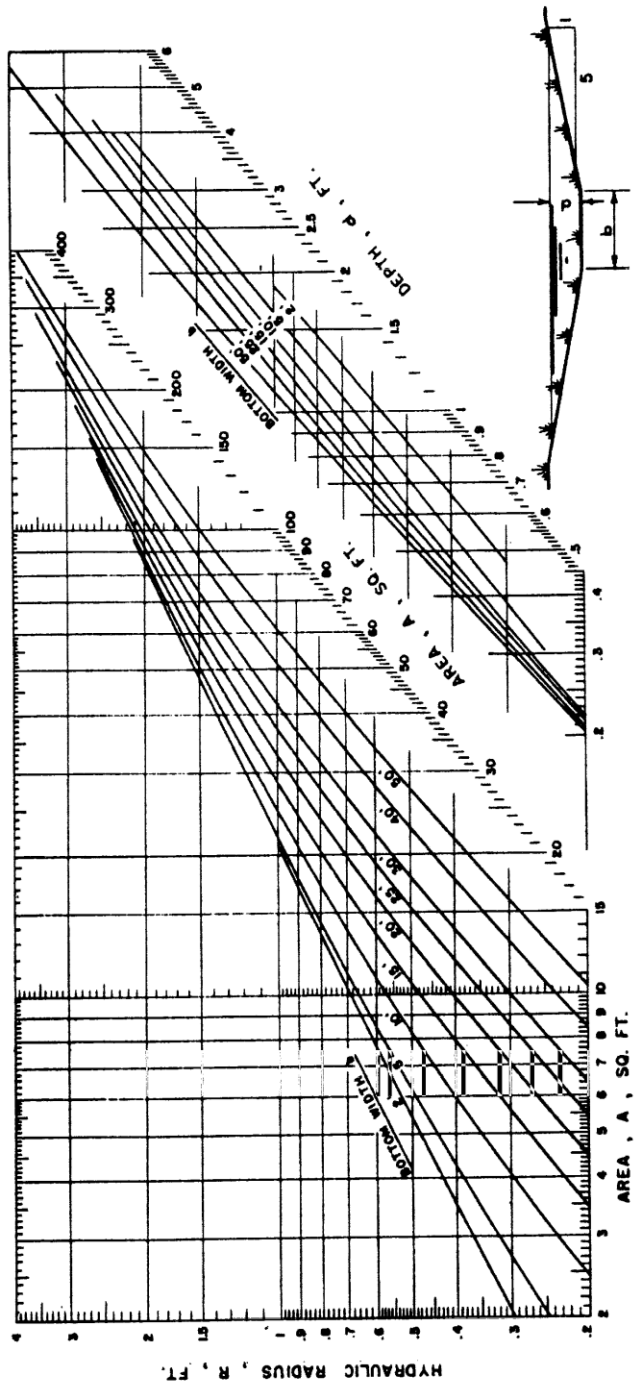

FIGURE A6-6
DIMENSIONS OF TRAPEZIODAL CHANNELS WITH 5 TO 1 SIDE SLOPES

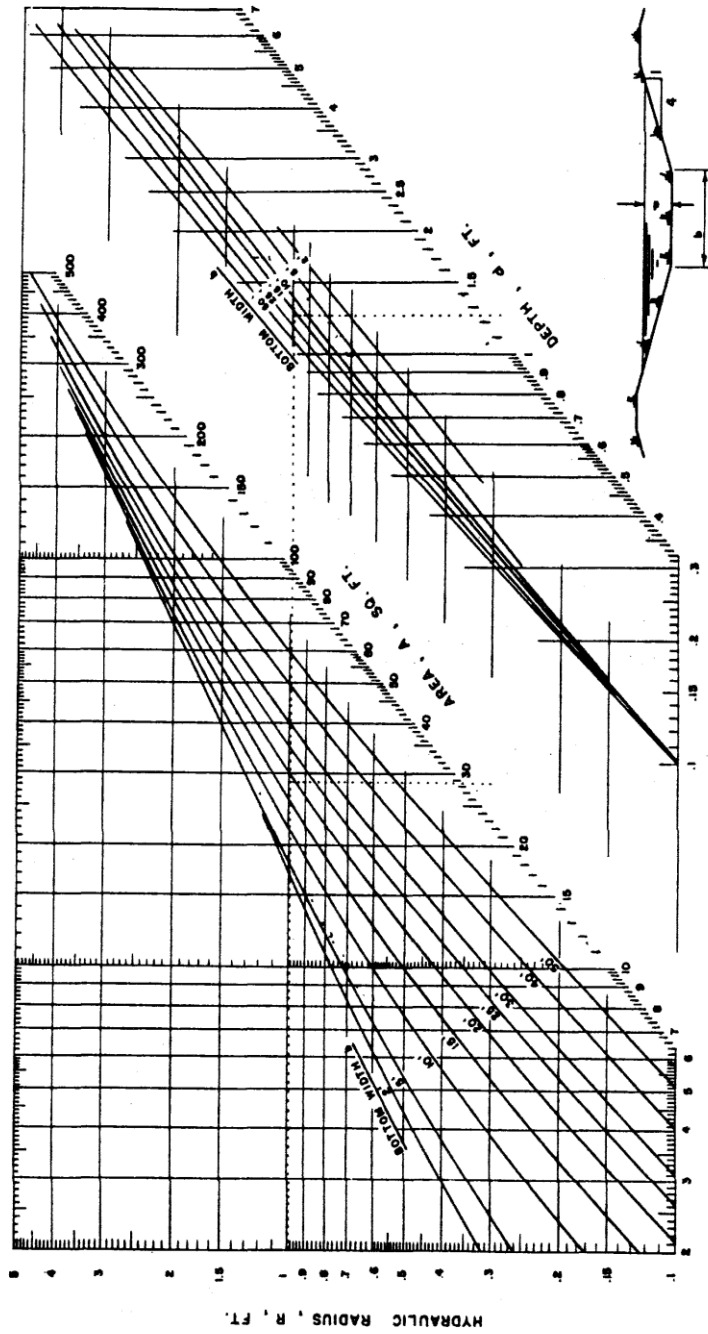

FIGURE A6-7
DIMENSIONS OF TRAPEZOIDAL CHANNELS WITH 4 TO 1 SIDE SLOPES

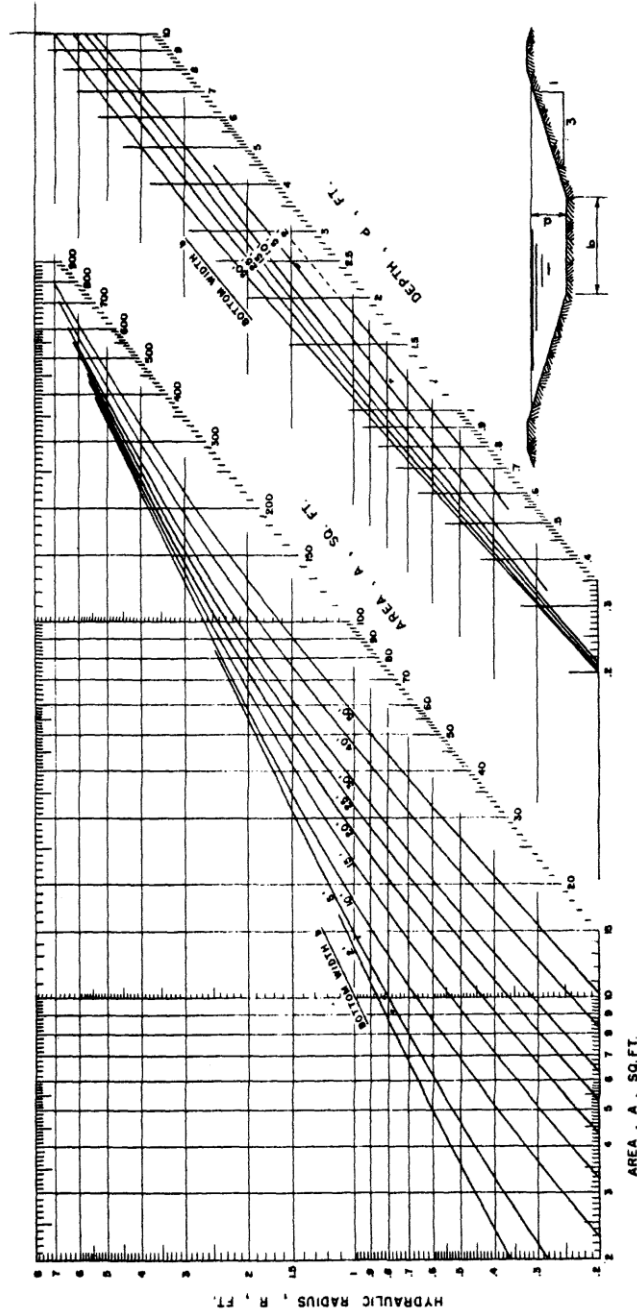

FIGURE A6-8
DIMENSIONS OF TRAPEZOIDAL CHANNELS WITH 3 TO 1 SIDE SLOPES

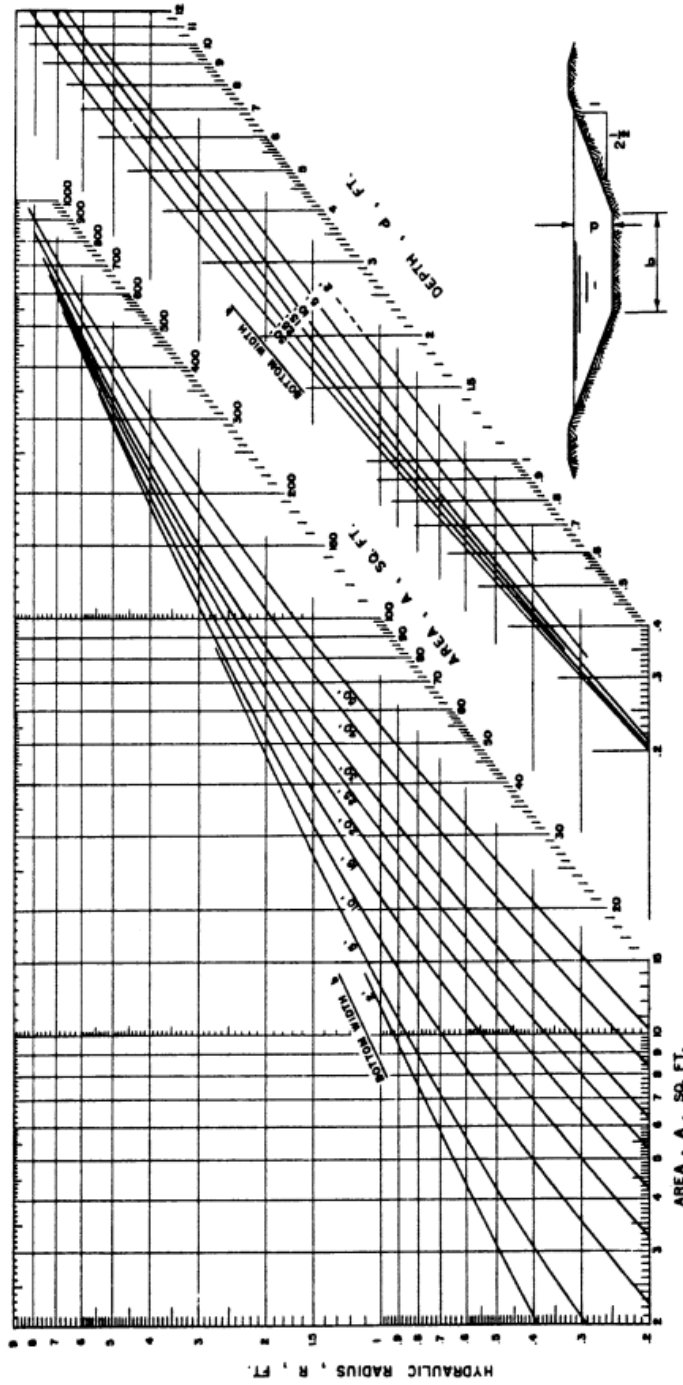

FIGURE A6-9
DIMENSIONS OF TRAPEZOIDAL CHANNELS WITH 2-1/2 TO 1 SIDE SLOPES

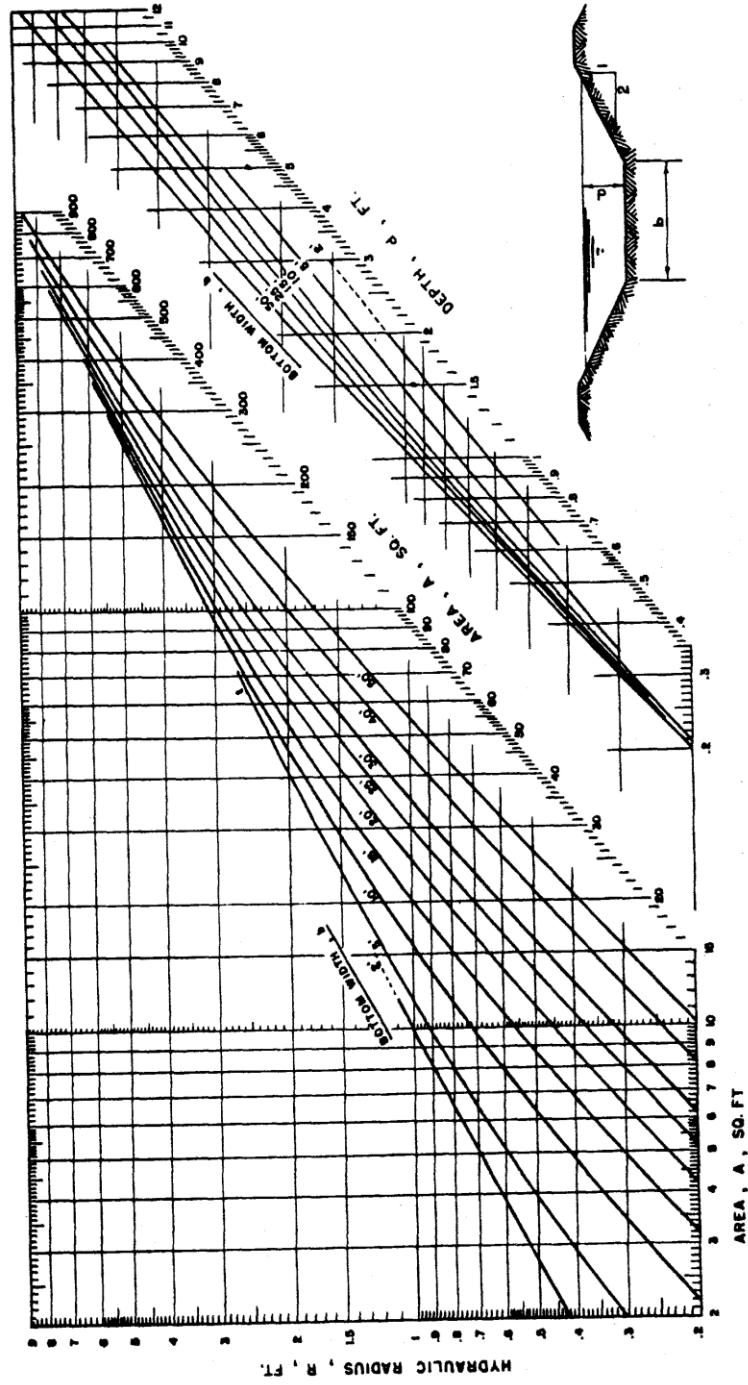

FIGURE A6-10
DIMENSIONS OF TRAPEZOIDAL CHANNELS WITH 2 TO 1 SIDE SLOPES

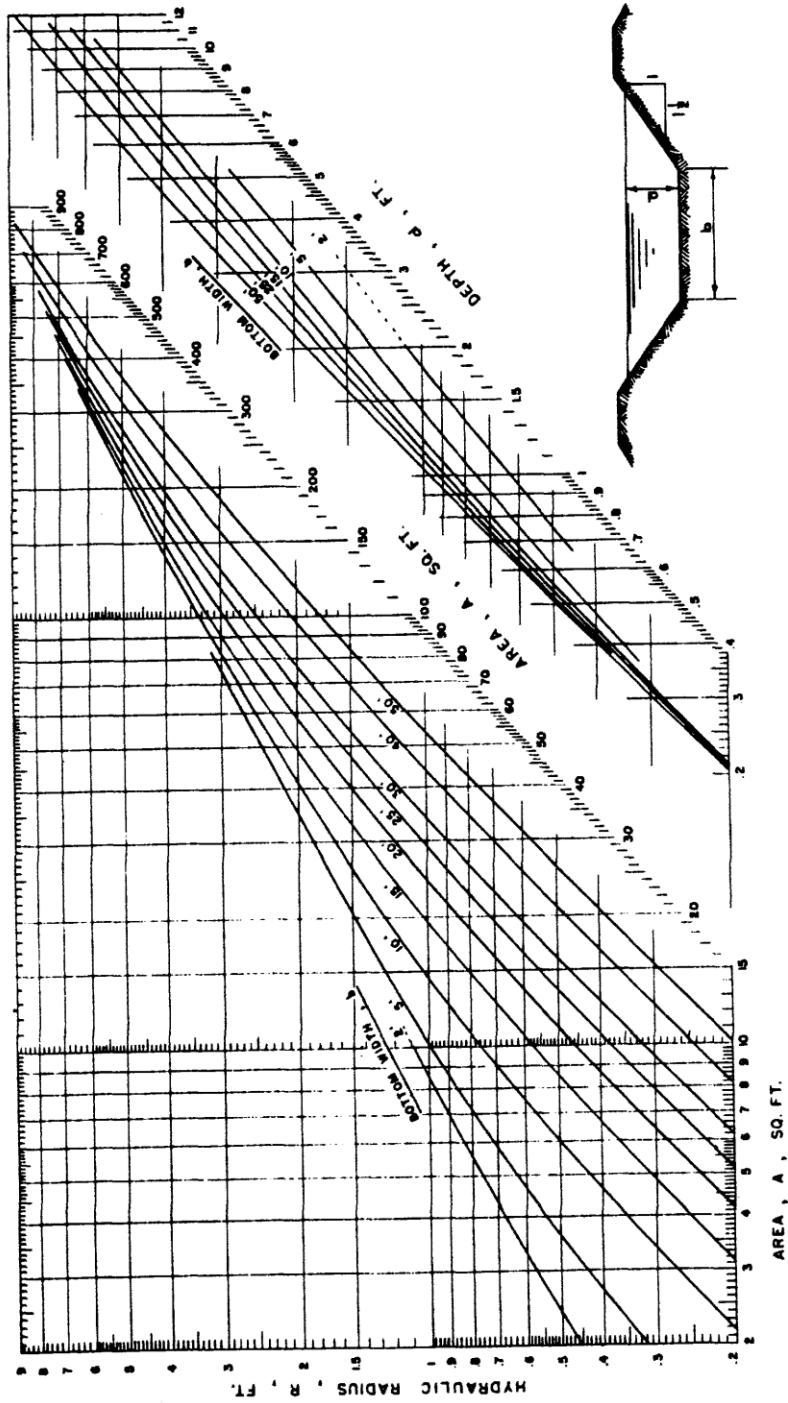

FIGURE A6-11
DIMENSIONS OF TRAPEZOIDAL CHANNELS WITH 1-1/2 TO 1 SIDE SLOPES

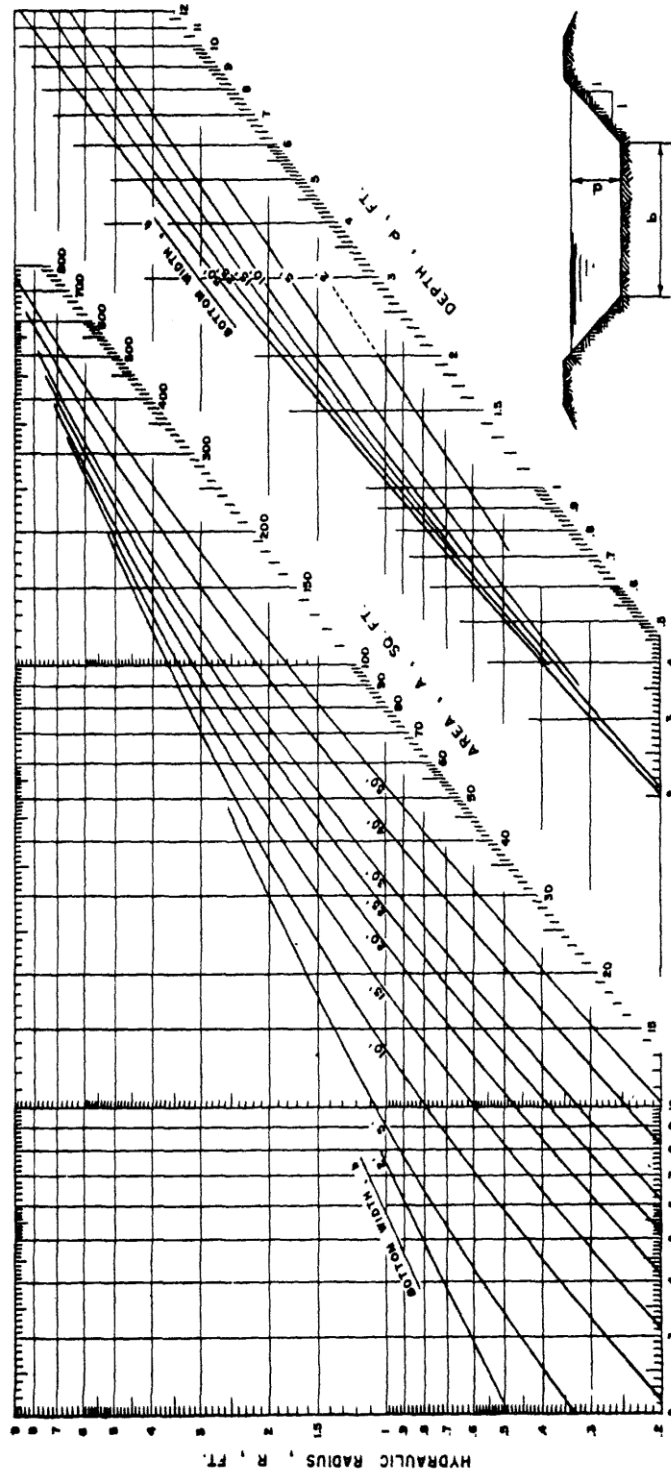

FIGURE A6-12
DIMENSIONS OF TRAPEZOIDAL CHANNELS WITH 1 TO 1 SIDE SLOPES

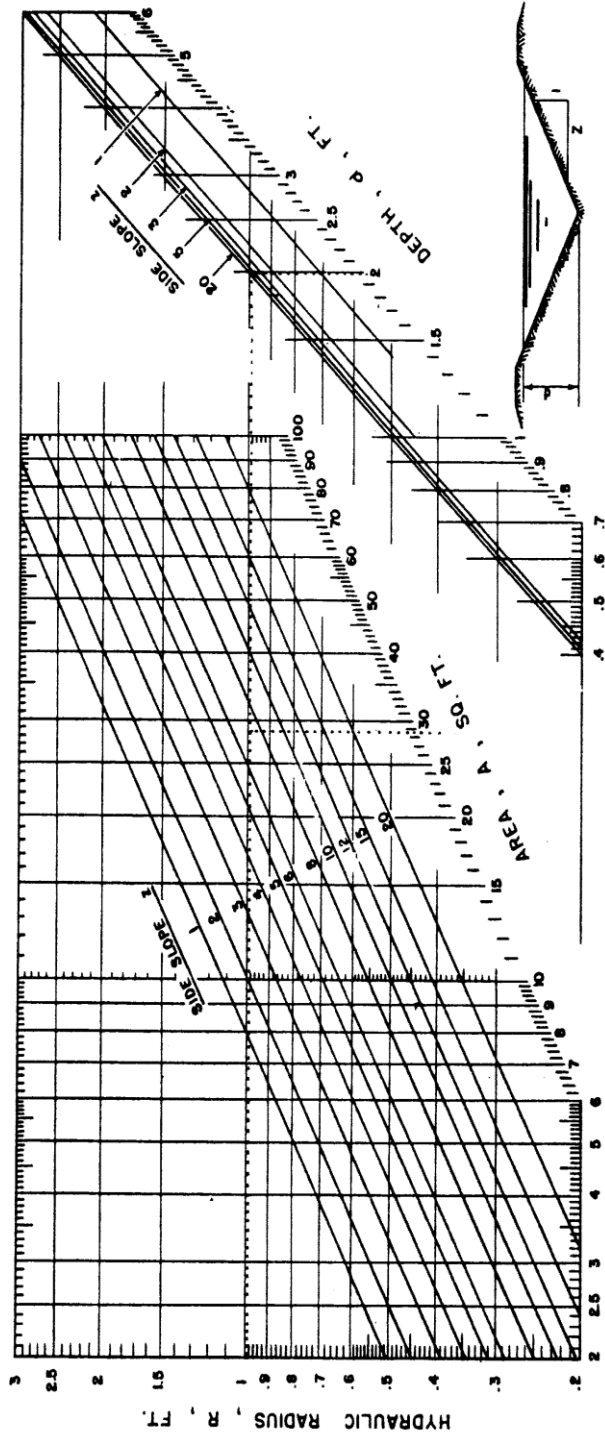
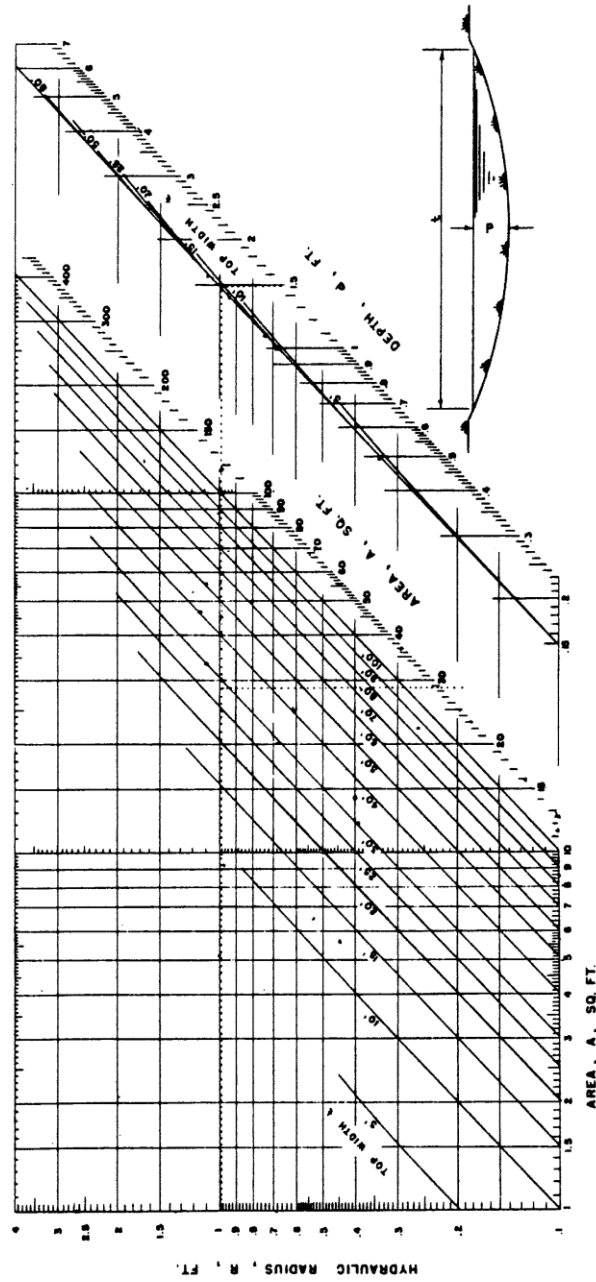

FIGURE A6-13
DIMENSIONS OF TRIANGULAR CHANNELS



NOTE: THIS CHART TO BE USED IN CONJUNCTION WITH THE NOMOGRAPHIC SOLUTION (FIG. A6-15)

FIGURE A6-14
DIMENSIONS OF PARABOLIC CHANNELS

APPENDIX A7

DETERMINING VOLUME IN A SEDIMENT BASIN
TO MEET TRAP EFFICIENCY,
SEDIMENT STORAGE AND
TEMPORARY FLOODWATER STORAGE REQUIREMENTS

Sample Problem #1

At Toms River in Ocean County, 100 acres drains into a planned sediment basin. Failure of the sediment basin at the planned site will not result in loss of life or damage to buildings, roads, railroads or utilities. Ten acres are to be cleared and developed into houses. Ninety acres are in woods and will not be disturbed during the life of the sediment basin. It is estimated it will take 18 months to develop the site. The sediment basin will be installed as the first item of construction and removed as the last item of construction. The owner estimates that the 10 acres to be developed will be bare for 12 months and under roofs, pavement, and sod for the last 6 months of construction. The soils are Woodmansie sand. The sediment pool will be normally dry.

- I. Determine minimum basin volume to meet the 70% trap efficiency requirement. Set trap efficiency at 75% to meet actual trap efficiency requirement of 70% for a dry sediment pool with coarse sediment, as required by the standard in the section on Trap Efficiency.

Enter Curve 4.4-1 with 75%. Find $C/I = 0.025$ using curve for coarse grained sediments. From Figure 4.4-1, average annual surface runoff for Toms River is 25 inches; $I = (25 \text{ in}) (1 \text{ ft}/12 \text{ in}) (100 \text{ ac})$

$$I = 208.3 \text{ Ac ft}$$

$$C = (208.3 \text{ ac. ft.}) (0.025)$$

$C = 5.21 \text{ ac. ft.} =$ minimum volume in the sediment basin below emergency spillway elevation to obtain 70% trap efficiency with a dry pool.

- II. Determine minimum basin volume to meet the requirements for sediment storage and temporary floodwater storage.
1. Determine volume for sediment storage using Method 2 in the standard under Sediment Storage Capacity.

- a. Determine, DA and A, Drainage Area and Average Annual Erosion

1st year

Woods

$$(DA) (A) = 90 \text{ ac} \times 0.2 \text{ tons/ac/yr} = 18 \text{ tons/yr}$$

Construction Area

$$(DA) (A) = 10 \text{ ac} \times 60 \text{ tons} = 600 \text{ tons/yr}$$

$$(DA) (A) = 618 \text{ tons for the 1st year.}$$

2nd year

$$\text{Woods (DA) (A)} = 90 \text{ ac} \times 0.2 \text{ tons/ac/yr} = 18 \text{ tons/yr}$$

Urban Area

$$(DA) (A) = 10 \text{ ac} \times 1.0 \text{ tons/ac/yr} = 10 \text{ tons/yr}$$

$$(DA) (A) = (18 + 10) (1/2) = 14 \text{ tons for 2nd year}$$

for six month life.

$$(DA) (A) = 618 + 14 = 632 \text{ tons for the life of the basin.}$$

- b. Determine DR, delivery ratio

$$100/640 = 0.16 \text{ sq mi from Figure 4.4-2 for a sandy soil, } \underline{DR = 24\%}$$

- c. Determine ρ , density of the sediment. From Table 4.4-1 the density of aerated sand is 85-100 lbs/ cu ft., Use $\rho = 90 \text{ lbs/cu ft.}$

- d. Determine minimum volume for sediment storage for the planned life of the structure.

$$V = (DA) (A) (DR) (TE) (1/\rho) (2,000 \text{ lbs/ton})$$

$$(1/43,560 \text{ sq. ft./ac.})$$

$$V = (632) (0.24) (0.70) (1/90) (2,000) (1/43,560)$$

$$V = 0.054 \text{ Ac. ft.}$$

2. Determine minimum volume for temporary floodwater storage.

- a. The standard requires that we have at least 1 foot between the crest of the principal spillway and the crest of the emergency spillway and that the runoff from the 2 year frequency 24 hour duration storm not cause flow in the emergency spillway. See the sections in the standard on Sediment Basin Volume and Principal Spillway.

- b. The 2 year 24 hour rainfall is 3.5 inches and the hydrologic soil group for Woodmansie sand is B from reference #1.

- c. From reference #9, Urban Hydrology for Small Watersheds, the runoff curve number is 58. The runoff is 0.45 watershed inches from a 2 yr 24 hr storm.

- d. The size of principal spillway pipe selected will have an effect on the volume of temporary floodwater storage required. For this site we selected a 18" CMP riser with a 12" CMP outlet. From the site survey and the preliminary layout of the principal spillway we found that the capacity of the spillway is approximately 5 cfs.

- e. Using the above principal spillway and the approximate flood routing methods in reference 1, we find that 0.2 watershed inches is required for temporary floodwater storage for the 2 yr 24 hr storm.

- f. The minimum volume for temporary floodwater storage using the 12 inch CMP principal spillway is 0.2 watershed inches or converting to ac.ft. is 1.67 ac.ft.

3. The minimum basin volume to meet the requirement for sediment storage capacity and temporary floodwater storage is $0.054 \text{ ac.ft} + 1.67 \text{ ac.ft} = \underline{1.72 \text{ ac. ft.}}$

- III. The standard under Sediment Basin Volume requires that we provide volume for the larger of the two values calculated above under I and II.

The volume for 70% trap efficiency is 5.21 ac. ft. The volume for sediment and temporary

floodwater storage is 1.72 ac. ft. Therefore, we must provide below the crest of the emergency spillway at least 5.21 ac. ft. of volume.

Sample Problem #2

Same as Sample Problem #1, except location is Morristown and the soils are Parsippany silt loam.

- I. Determine minimum basin volume to meet the 70% trap efficiency requirement. Set trap efficiency at 80% to meet actual trap efficiency requirement of 70% for a dry sediment pool with fine sediment. From Curve 4.4-1, using curve for fine grained sediment, $C/I = 0.12$. From Figure 4.4-1, $I = 23\text{-}1/2$ inches for Morristown. $I = (23\text{-}1/2 \text{ in}) (1 \text{ ft}/12 \text{ in.}) (100 \text{ ac}) = 196 \text{ ac. ft.}$ $C = 23.5 \text{ ac. ft.} = \text{minimum volume for 70\% trap efficiency.}$
- II. Determine minimum basin volume to meet the requirements for sediment storage and temporary flood water storage.
 1. Determine volume for sediment storage using Method 2 in the standard under Sediment Storage Capacity.
 - a. (DA) (A) same as in Sample Problem #1
 (DA) (A) = 618 tons for the 1st year
 (DA) (A) = 14 tons for the 2nd year
 - b. Determine, DR, delivery ratio.
 The Parsippany soil is described in the soil survey report as a silt loam, clay loam or silty clay loam at different depths. Therefore, in Figure 4.4-2, use the curve for silty clay with 0.16 sq. mi. drainage area, DR = 72%.
 - c. Determine, ρ , density of sediment. $\rho = 80 \text{ lbs/cu ft}$, using Table 4.4-1 with clay-silt mixture with more silt than clay.
 - d. Determine minimum volume for sediment storage for the planned life of the structure.

$$V = (\text{DA}) (A) (\text{DR}) (\text{TE}) (1/\rho) (2,000 \text{ lbs./ton}) \\ (1/43,560 \text{ sq. ft./Ac.})$$

$$V = (618 + 14) (0.72) (0.70) (1/80) (2,000) (1/43,560) \\ V = 0.18 \text{ ac ft}$$

2. Determine minimum volume for temporary floodwater storage.
 - a. The standard requires that we have at least 1 foot between the crest of the principal spillway and the crest of the emergency spillway and that the runoff from the 2 year frequency 24 hour duration storm not cause flow in the emergency spillway. See the sections in the standard on Sediment Basin Volume and Principal Spillway.
 - b. The 2 year 24 hour rainfall is 3.3 inches and the hydrologic soil group for Parsippany silt loam is D, from Reference #1.

- c. From Reference #9, Urban Hydrology for Small Watershed, the runoff is 1.42 watershed inches from a 2 yr 24 hr storm.
- d. The size of principal spillway pipe selected will have an effect on the volume of temporary floodwater storage required. For this site we selected a 18" cmp riser with a 12" cm outlet. From the site survey and the preliminary layout of the principal spillway we found that the capacity of this spillway is approximately 5 cfs.
- e. Using the above principal spillway and the approximate flood routing methods in Reference 1, we find that 0.9 watershed inches is required for temporary floodwater storage for the 2 yr 24 hr storm.
- f. The minimum volume for temporary floodwater storage using the 12 inch cmp principal spillway is 0.9 watershed inches or converting to ac. ft. is 7.5 ac. ft.

3. The minimum basin volume to meet the requirement for sediment storage capacity and temporary floodwater storage is 0.18 ac. ft. + 7.5 ac. ft. = 7.68 ac. ft.

III. The standard under Sediment Basin Volume requires that we provide volume for the larger of the two values calculated above under I and II.

The volume for 70% trap efficiency is 23.5 ac. ft. The volume for sediment and temporary floodwater storage is 7.68 ac. ft. Therefore, we must provide below the crest of the emergency spillway at least 23.5 ac. ft. of volume.

Conclusions From Sample Problems

To have a reasonably sized sediment basin that is effective, two factors are critical. The total drainage area must be small and the sediment must be coarse textured, or the basin becomes excessively large.

The effect of sediment size is shown by the difference in basin size from Sample Problem #1 to #2. When changing from a sand typical of South Jersey to a siltclay typical of North Jersey, the minimum basin volume goes from 5.21 ac. ft. to 23.5 ac. ft.

If the soils were silt and clay and the basin was located so that the only drainage area was the 10 disturbed acres, the minimum basin volume would be 2.3 ac. ft. With sand sediments and a 10 ac. drainage area, the minimum basin volume would be 0.5 ac. ft.

METHODS OF DEWATERING SEDIMENT BASINS

The dewatering methods shown here are inexpensive and operate automatically.

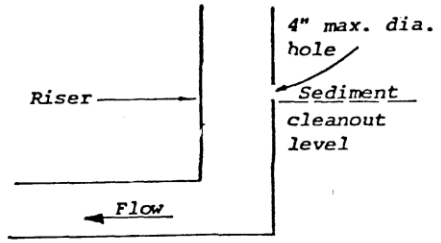
<u>METHOD</u>	<u>COMMENTS</u>
<p>A.</p> 	<p>Easy to construct May clog with trash Non-skimming Capable of draining down to sediment clean-out level</p>

CROSS-SECTION

B. Same as "A" except for skimming device, detailed below:

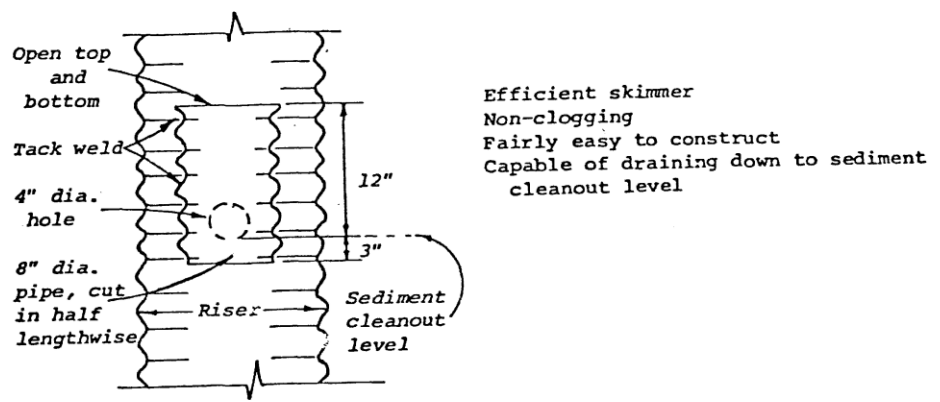

ELEVATION

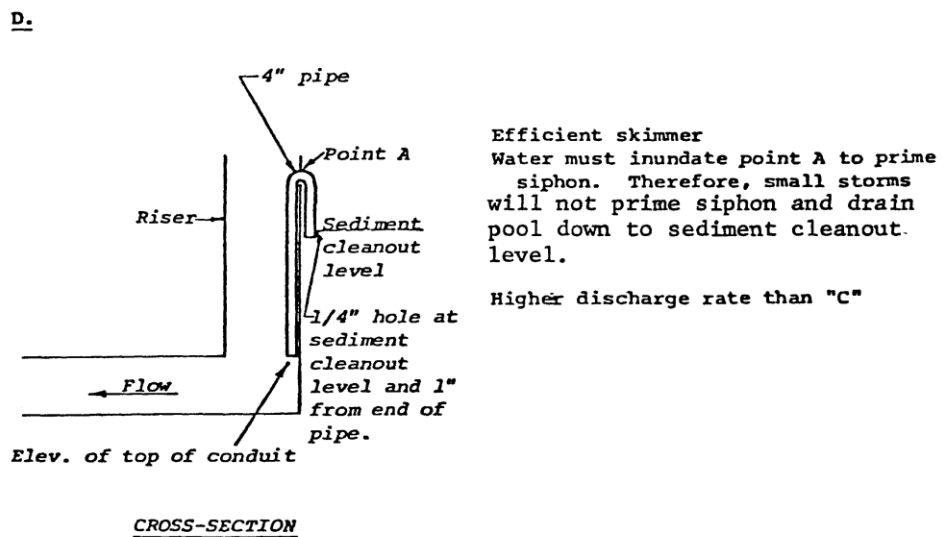
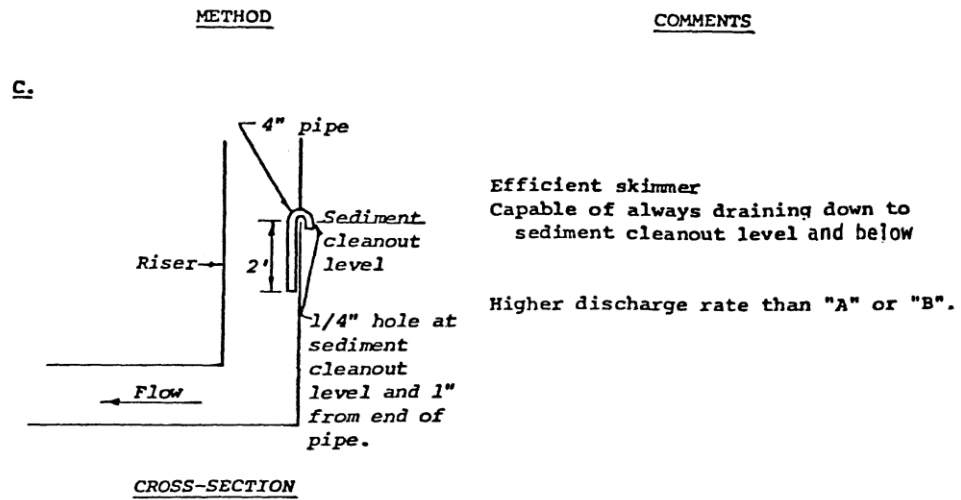

DEWATERING SEDIMENT BASIN WITH SUBSURFACE DRAIN

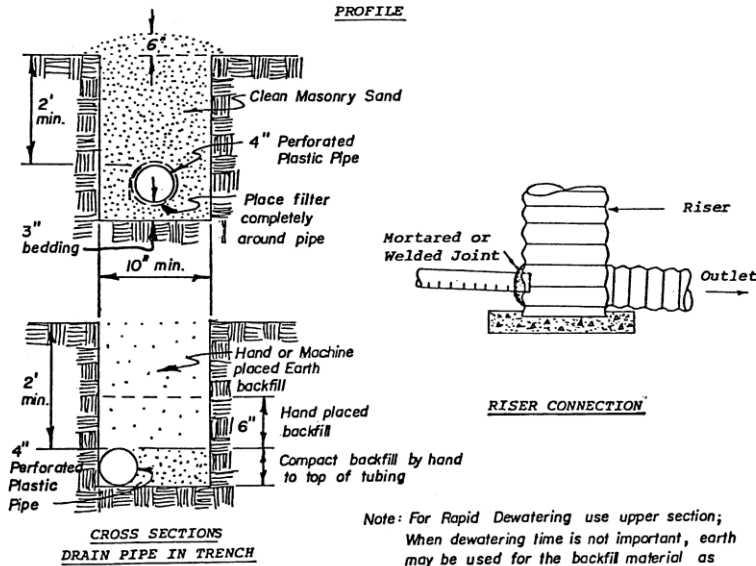
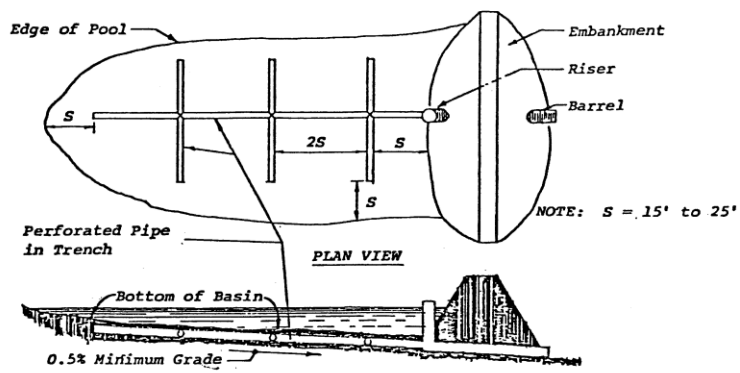

Note: For Rapid Dewatering use upper section;
 When dewatering time is not important, earth
 may be used for the backfill material as
 shown in lower section.

Dewatering with Skimmers

Skimmer-type dewatering devices may be considered to improve sediment trapping efficiency. Since skimmers operate at the surface of the ponded water, they will not draw sediment laden water from the submerged volume of the basin. Skimmers are mechanically more complex and will require frequent inspection and maintenance in order to operate as designed. Skimmers may not work during winter months when surface waters freeze, preventing the skimmer from moving downward.

Skimmers must be removed once the sediment trapping function of the basin is completed and the basin is ready for permanent stormwater control.

When connecting the skimmer to the outlet structure where the outlet orifice is larger than the PVC pipe diameter, the orifice may require a temporary plate, reducer-coupling or mortar plug to form a flexible, watertight connection.

APPENDIX A8

CHANNEL STABILITY ANALYSIS PROCEDURE

Introduction

The evaluation or design of any water conveyance system that includes earth channels requires knowledge of the relationships between flowing water and the earth materials forming the boundary of the channel, as well as an understanding of the expected stream response when structures, lining, vegetation, or other features are imposed. These relationships may be the controlling factors in determining channel alignment, grade, dimensioning of cross section and selection of design features to assure the operational requirements of the system.

The methods included herein to evaluate channel stability against the flow forces are for bare earth. The magnitude of the channel instability needs to be determined in order to evaluate whether or not structural measures are needed. Where such practices or measures are required, methods of analysis that appropriately evaluate the stream's response should be used.

All terms used in this appendix are defined in the glossary, pg. D-1.

Allowable Velocity ApproachGeneral

This method of testing the erosion resistance of earth channels is based on data collected by several investigators.

Figure A4-1 shows "Allowable Velocities for Unprotected Earth Channels" developed chiefly from data by Fortier and Scobey al., Lane a2., by investigators in the U.S.S.R. a3, and others.

Stability is influenced by the concentration of fine material carried by the flow in suspension. There are two distinct types of flow depending on concentration of material in suspension.

1. Sediment free flow is defined as the condition in which fine material is carried in suspension by the flow at concentrations so low that it has no effect on channel stability. Flows with concentrations lower than 1,000 ppm by weight are treated as sediment free flows.
2. Sediment laden flow is the condition in which the flow carries fine material in suspension at moderate to high concentrations so that stability is enhanced either through replacement of dislodged particles or through formation of a protective cover as the result of settling. Flows in this class carry sediment in suspension at concentrations equal or larger than 20,000 ppm by weight.

Sediment transport rates are usually expressed in tons per day.

To covert them into concentration use the equation:

$$C = 370 \left(\frac{Q_s}{Q} \right) \quad (\text{Eq. A8-1})$$

Depending on the type of soil, the effect of concentration of fine sediment (material smaller than 0.074 mm) in suspension on the allowable velocity is obtained from the curves on Figure A8-1.

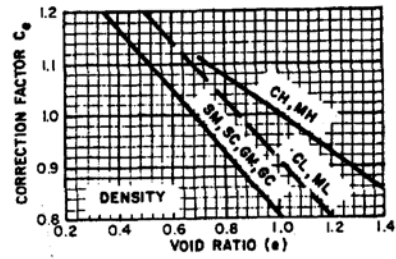
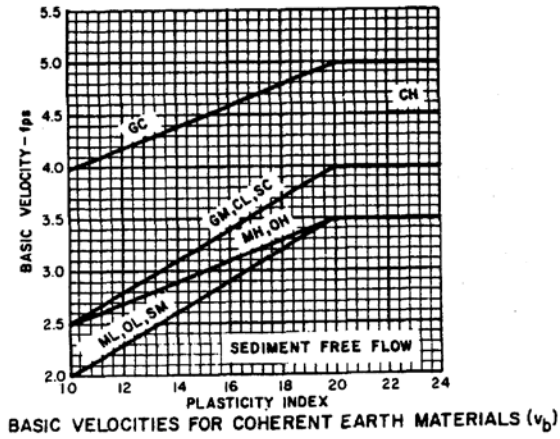
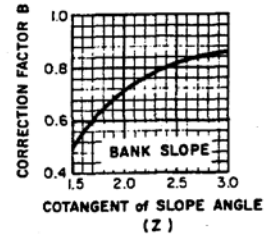
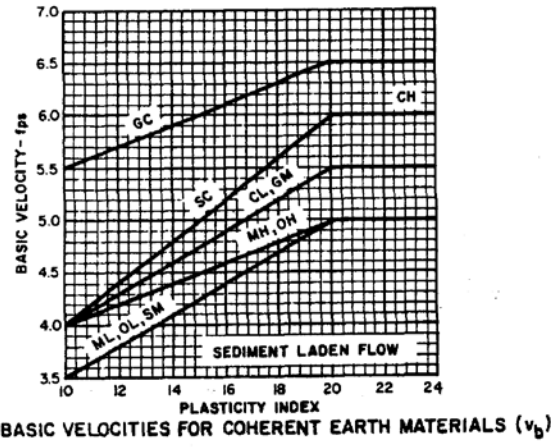
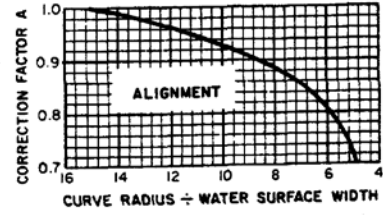
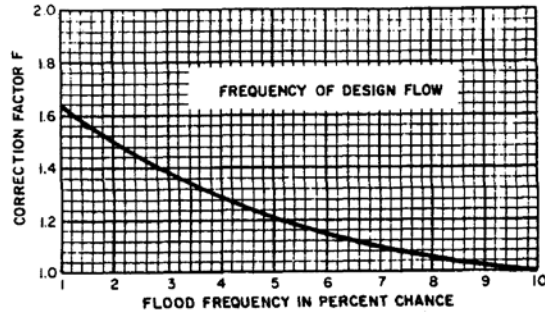

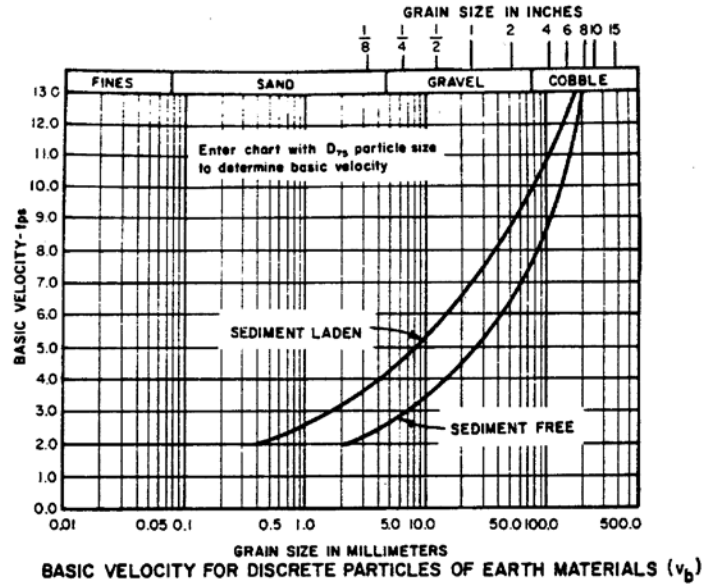

ALLOWABLE VELOCITIES FOR UNPROTECTED EARTH CHANNELS	
CHANNEL BOUNDARY MATERIALS	ALLOWABLE VELOCITY
DISCRETE PARTICLES	
Sediment Laden Flow	
$D_{75} > 0.4 \text{ mm}$	Basic velocity chart value $\times D \times A \times B$
$D_{75} < 0.4 \text{ mm}$	2.0 fps
Sediment Free Flow	
$D_{75} > 2.0 \text{ mm}$	Basic velocity chart value $\times D \times A \times B$
$D_{75} < 2.0 \text{ mm}$	2.0 fps
COHERENT EARTH MATERIALS	
$P_i > 10$	Basic velocity chart value $\times D \times A \times F \times C_e$
$P_i < 10$	2.0 fps

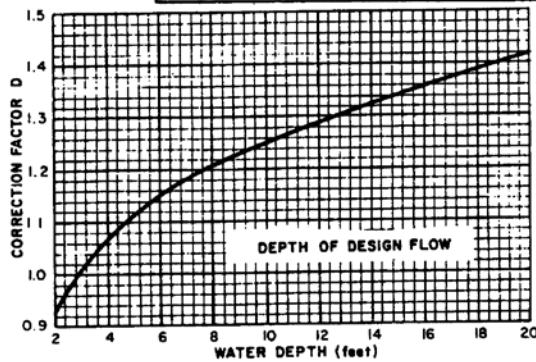

NOTES:

1. In no case should the allowable velocity be exceeded when the 10% chance discharge occurs, regardless of the design flow frequency.
2. The maximum permissible velocity for bare sand channels is 1.75 fps.

FIGURE A8-1
ALLOWABLE VELOCITIES
FOR UNPROTECTED EARTH CHANNELS

If the suspended sediment concentration equals or exceeds 20,000 ppm by weight, use the sediment laden curve on Figure A8-1. If the suspended sediment concentration is 1,000 ppm or less by weight, use the sediment free curve on Figure A8-1. A linear interpolation may be made between these curves for suspended sediment concentrations between 1,000 ppm and 20,000 ppm.

Adjustment in the basic velocity to reflect the modifying effects of frequency of runoff, curvature in alignment, bank slopes, density of bed and bank materials, and depth of flow are made using the adjustment curves on Figure A8-1.

The alignment factor, A, and the depth factor, D, apply to all soil conditions. The bank slope factor, B, applies only to channels in soils that behave as discrete particles. The frequency correction, F, applies only to channels in soils that resist erosion as a coherent mass. The density correction factor, Ce, applies to all soil materials except clean sands and gravels (containing less than 5 percent material passing size #200).

Figure A8-1 gives the correction factors (F) for frequencies of occurrence lower than 10 percent. Channels designed for less frequent flows using this correction factor should be designed to be stable at the 10 percent chance frequency discharge as well as at the design discharge.

If the soils along the channel boundary behave as discrete particles with D_{75} larger than 0.4 mm for sediment laden flow or larger than 2.0 mm for sediment free flow, the allowable velocity is determined by adjusting the basic velocity read from the curves on Figure A8-1 for the effects of alignment, bank slope, and depth. If the soils behave as discrete particles and D_{75} is smaller than 0.4 mm for sediment laden flow or 2.0 mm for sediment free flow, the allowable velocity is 2.0 fps. For channels in these soils, no adjustments are to be made to the basic velocity of 2.0 fps.

In cases where the soils in the channel boundary resist erosion as a coherent mass, the allowable velocity is determined by adjusting the basic velocity from Figure A8-1 for the effects of depth, alignment, bank slope, frequency of occurrence of design flow, and for the density of the boundary soil materials.

Design Procedure for Allowable Velocity Approach

The use of the allowable velocity approach in checking the stability of earth channels involves the following steps:

1. Determine the hydraulics of the system. This includes hydrologic determinations as well as the stage-discharge relationships for the channel considered.
2. Determine the properties of the earth materials forming the banks and bed of the design reach and of the channel upstream.
3. Determine sediment yield to attain and calculate sediment concentration for design flow. In most cases, sediment free conditions exist and should be used unless the designer can prove otherwise.
4. Check to see if the allowable velocity procedure is applicable.
5. Compare the design velocities with the allowable velocities from Figure A8-1 for the materials forming the channel boundary.

Examples of Allowable Velocity ApproachExample 1

Given: A channel is to be constructed to convey the flow from a 2 percent chance flood. The hydraulics of the system indicate that a trapezoidal channel with 2:1 side slopes and a 40 foot bottom width will carry the design flow at a depth of 8.7 feet and a velocity of 5.45 fps. Soil investigations reveal that the channel will be excavated in a moderately rounded clean sandy gravel with a D_{75} size of 2.25 inches. Sampling of soils in the drainage area and estimate of erosion and sediment yield indicate that, on an average annual basis, approximately 1000 tons of sediment finer than 1.0 mm. and 20 tons of material coarser than 1.0 mm are available for transport in channel. The amount of abrasion resulting from the transporting of this small amount of sediment coarser than 1.0mm is considered insignificant. Sediment transport computations indicate all of the sediment supplied to the channel will be transported through the reach. The sediment transport and hydrologic evaluations indicate the design flow will transport the available sediment at a concentration of about 500 ppm. The channel is straight except for one curve with a radius of 600 feet.

Determine:

1. The allowable velocity, V_a , and
2. The stability of the reach.

Solution: Determine basic velocity from Figure A8-1, sediment free curve because sediment concentration of 500 ppm is less than 1,000 ppm.

$$V_b = 6 \text{ fps.}$$

Depth correction factor, $D = 1.22$ (from Figure A8-1).

Bank slope correction, $B = 0.72$ (from Figure A8-1).

Alignment correction A ,

$$\frac{\text{curve radius}}{\text{water surface width}} = \frac{600}{74.8} = 8.02$$

$A = 0.89$ (from Figure A8-1).

Density correction, C_e , does not apply.

Frequency correction, F , does not apply.

$$V_a \text{ (straight reaches)} = V_bDB = (6.7) (1.22) (0.72) = 5.88\text{fps}$$

$$V_a \text{ (curved reaches)} = V_bDBA = (6.7) (1.22) (0.72) (0.89) = 5.24\text{fps}$$

The proposed design velocity of 5.45 fps is less than $V_a = 5.88$ fps in the straight reaches but greater than $V_a = 5.24$ fps in the curved reaches. Either the channel alignment or geometry needs to be altered or the curve needs structural protection.

Example 2

Given: A channel is to be constructed to convey the flow from a 2 percent chance flood. The hydraulics of the

system indicate that a trapezoidal channel with 2:1 side slopes and a 40 foot bottom width will carry the design flow at a depth of 8.7 feet and a velocity of 5.45 fps. The channel is to be excavated into a silty clay(CL) soil with a Plasticity Index of 18, a dry density of 92 pcf, and a specific gravity of 2.71. Sediment transport evaluations indicate the design flow will have a fairly stable sediment concentration of about 500 ppm with essentially no bed material load larger than 1.0mm. The channel is straight except for one curve with a radius of 600 feet. The 10 percent chance flood results in a depth of flow of 7.4 feet and a velocity of 4.93 fps.

Determine:

1. The allowable velocity, V_a , and
2. The stability of the reach.

Solution: Sediment concentration of 500 ppm is less than 1,000 ppm, therefore it is classed as sediment free flow.

$V_b = 3.7$ fps (from Figure A8-1) for the 2 percent chance flood.

Depth correction, $D = 1.22$ (from Figure A8-1).

Density correction, compute e ;

$$e = G \left(\frac{\lambda_w}{\lambda_d} \right) - 1 = \frac{(2.71)(62.4)}{92} - 1 = 0.83$$

$C_e = 1.0$ (from Figure A8-1)

Frequency correction, $F = 1.5$ (from Figure A8-1)..

Alignment correction A ,

$$\frac{\text{Curve radius}}{\text{water surface width}} = \frac{600}{74.8} = 8.02$$

$A = 0.89$ (from Figure A8-1).

V_a (Straight reach) = $V_b DC_e F = (3.7)(1.22)(1.0)(1.5) = 6.77$ fps.

V_a (Curved reach) = $V_b DC_e FA = (3.7)(1.22)(1.0)(1.5)(0.89) = 6.03$ fps.

The design velocity is less than the allowable velocity for the 2 percent chance flow. Check the 10 percent chance flow velocity with no frequency correction against the allowable velocity for the 10 percent chance flow.

V_a (Straight reaches) = $V_b DC_e = (3.7)(1.19)(1.0) = 4.40$ fps.

V_a (Curved reaches) = $V_b DC_e A = (3.7)(1.19)(1.0)(0.90) = 3.96$ fps

The allowable velocity with no frequency correction is exceeded by the 10 percent chance flow velocity. Channel alignment, slope or geometry must be altered or the channel must be protected.

Tractive Stress Approach

General

The tractive force is the tangential pull of flowing water on the wetted channel boundary; it is equal to the total

friction force that resists flow but acts in the opposite direction. Tractive stress is the tractive force per unit area of the boundary. The tractive force is expressed in units of pounds, while tractive stress is expressed in units of pounds per square foot. The tractive force in a prismatic channel reach is equal to the weight of the fluid prism multiplied by the energy gradient.

The tractive stress approach to channel stability analysis provides a method to evaluate the stress at the interface between flowing water and the materials in the channel boundary.

The method for obtaining the actual tractive stress acting on the bed or sides of a channel and the allowable tractive stress depends on the D_{75} size of the materials involved. When coarse grained discrete particle soils are involved, Lane's a2. method is used. When fine grained soils are involved, a method derived from the work of Keulegan and modified by Einstein a4., and Vanoni and Brooks, a5., is used. The separation size for this determination is $D_{75} - 1/4$ inch.

Coarse-grained Discrete Particle Soils - $D_{75} \geq 1/4$ inch - Lane's Method

A. Determination of Actual Tractive Stress

1. Actual tractive stress in an infinitely wide channel.

Generally, Manning's roughness coefficient "n" reflects the overall impedance to flow including grain roughness, form roughness, vegetation, curved alignment, etc. Lane's a2 work showed that for soils with a D_{75} size between 0.25" (6.35 mm) and 5.0" (127mm) the value of Manning's coefficient "n" resulting from the roughness of the soil particles is determined by:

$$n_t = \frac{(D_{75})^{1.46}}{39} \quad \text{with } D_{75} \text{ expressed in inches} \quad (\text{Eq. A8-2})$$

The value of n_t determined by the equation above represents the retardance to flow caused by roughness of the soil grains.

The value of n_t can be used to compute s_t , the friction gradient associated with the particular boundary material being considered.

$$s_t = \left(\frac{n_t}{n}\right) N^2 s_e \quad (\text{Eq. A8-3})$$

The tractive stress acting on the soil grains in an infinitely wide channel is found by:

$$\tau_4 = \gamma_w ds_t \quad (\text{Eq. A8-4})$$

where the terms are as defined in the glossary.

2. Distribution of the tractive stress along the channel perimeter:

In open channels the tractive stresses are not distributed uniformly along the perimeter. Laboratory experiments and field observations have indicated that in trapezoidal channels the stresses are very small near the water surface and near the corners of the channel and assume their maximum value near the center of the bed. The maximum value on the banks occurs near the lower third point.

Figures A8-2 and A8-3 give the maximum tractive stresses in a trapezoidal channel in relation to the tractive stress in an infinitely wide channel having the same depth of flow and value of s_t .

3. Tractive stresses on curved reaches:

Curves in channels cause the maximum tractive stresses to increase above those in straight channels. The maximum tractive stresses in a channel with a single curve occur on the inside bank in the upstream portion of the curve and near the outer bank downstream from the curve. Compounding of curves in a channel complicates the flow pattern and causes a compounding of the maximum tractive stresses.

Figure A8-4 gives values of maximum tractive stresses based on judgment coupled with very limited experimental data. It does not show the effect of depth of flow and length of curve and its use is only justified until more accurate information is obtained. Figure A8-5, with a similar degree of accuracy, gives the maximum tractive stresses at various distances downstream from the curve.

B. Allowable Tractive Stress

The allowable tractive stress for channel beds, τ_{Lb} , composed of soil particles with discrete, single grain behavior with a given D_{75} is:

$$\tau_{Lb} = 0.4D_{75} \quad \text{When } 0.25 \text{ in} < D_{75} < 5.0 \text{ in.} \quad (\text{Eq. A8-5})$$

The allowable tractive stress for channel sides, L_s is less than that of the same material in the bed of the channel because the gravity force aids the tractive stress in moving the materials. The allowable tractive stress for channel sides composed of soil particles behaving as discrete single grain materials, considering the effect of the side slope z and the angle of repose Φ_R with the horizontal is

$$\tau_{Ls} = 0.4KD_{75} \dots 0.25 < 5.0. \quad (\text{Eq. A8-6})$$

$$\text{Where: } K = \sqrt{\frac{z^2 - \cot^2 \Phi_R}{1 + z^2}} \quad (\text{Eq. A8-7})$$

Figure A8-6 gives an evaluation of the angles of repose corresponding to the degree of angularity of the material. Figure A8-7 gives values of K from Equation A8-7.

When the unit weight γ_s of the constituents of the material having a grain size larger than the D_{75} size is significantly different than 160 lb/ft^3 , the limiting tractive stress τ_{Lb} and τ_{Ls} as given by Equations (A8-5) and (A8-6) should be multiplied by the factor.

$$T = \frac{\gamma_s - \gamma_w}{97.6} \quad (\text{Eq. A8-8})$$

Fine Grained Soils - $D_{75} < 1/4$ inch

A. Determination of Actual Tractive Stress

1. Reference tractive stress -

The expression for reference tractive stress is: $\tau = \gamma_w R_{ts_e}$ (Eq. A8-9)

REFERENCE:
 Bureau of Reclamation "Progress Report
 on Results of Studies on Design of Stable
 Channels" Hyd-352

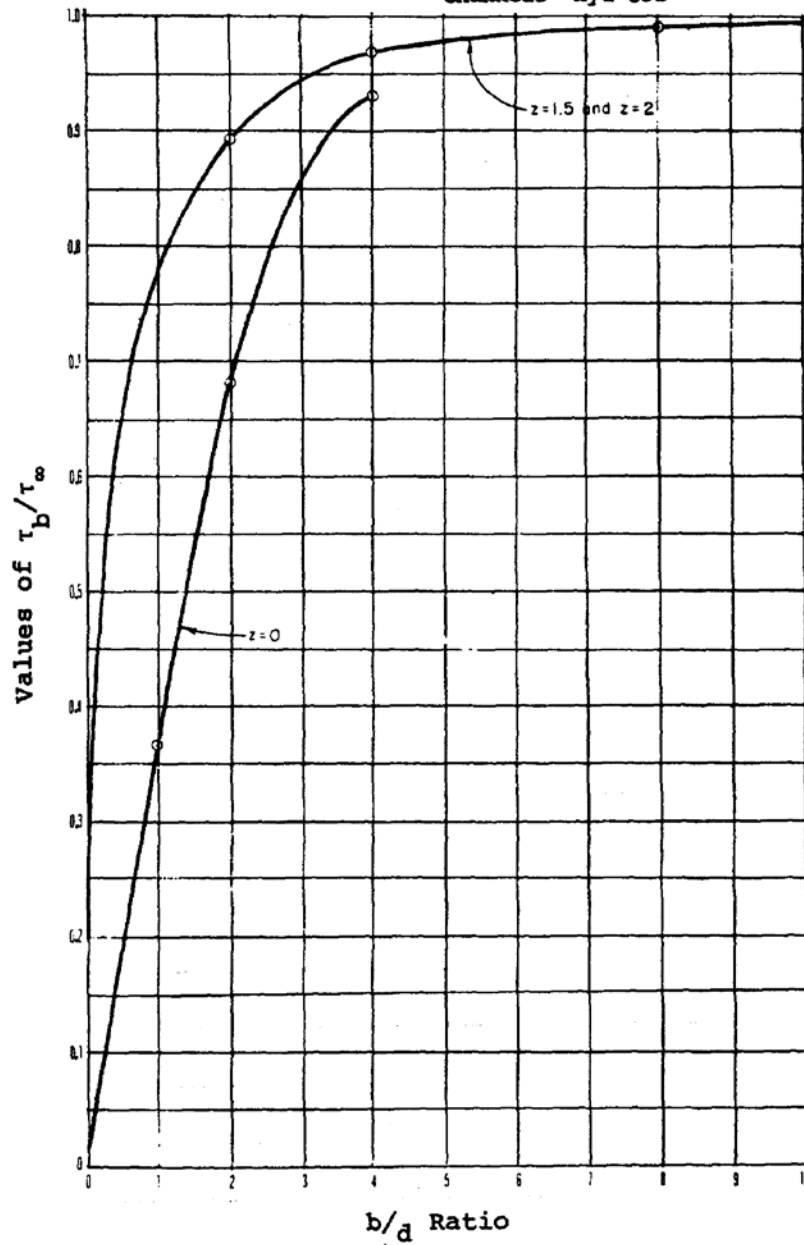

FIGURE A8-2

CHANNEL STABILITY: ACTUAL MAXIMUM TRACTIVE STRESS, τ_b , ON BED OF STRAIGHT TRAPEZOIDAL CHANNELS

REFERENCE
 Bureau of Reclamation "Progress Report
 of Results of Studies on Design of
 Stable Channels" Hyd-352

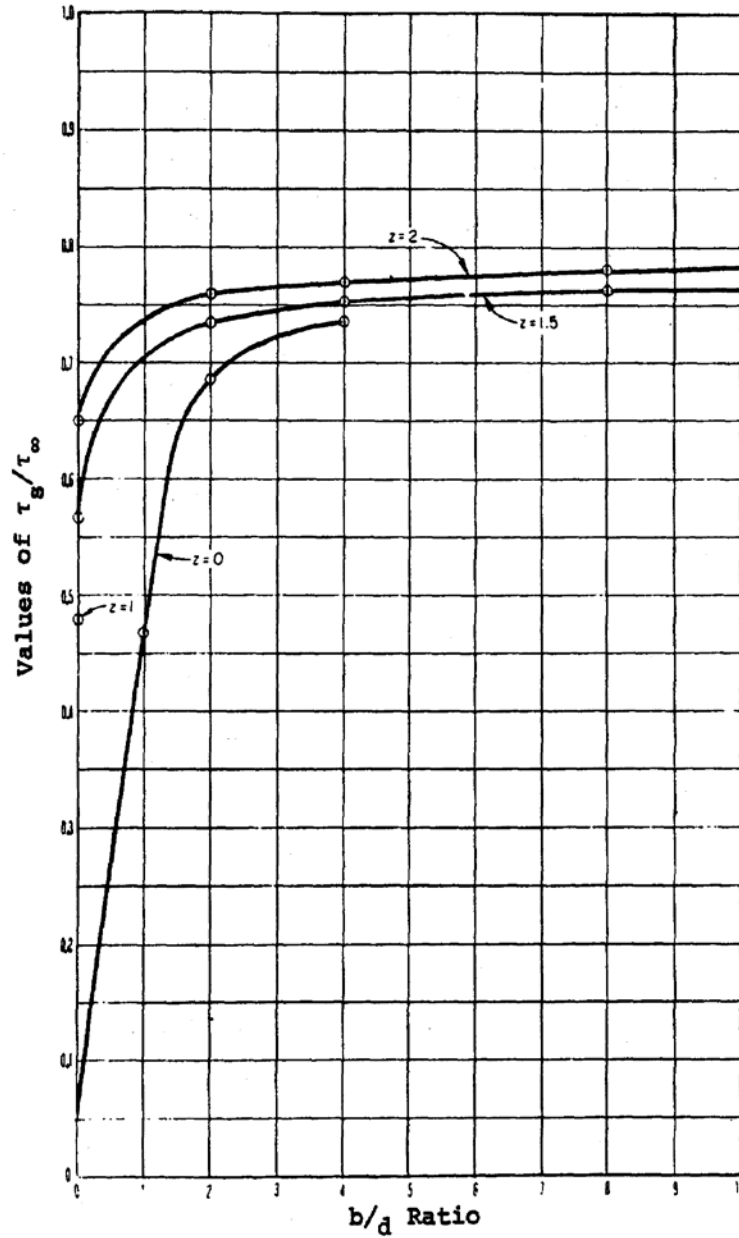

FIGURE A8-3
CHANNEL STABILITY; ACTUAL MAXIMUM TRACTIVE STRESS, τ_s , ON SIDES
OF STRAIGHT TRAPEZOIDAL CHANNELS

REFERENCE:

Lane, Emory W., Design of Stable Channels
 Transaction, A S C E, vol. 120, 1955

Nece, R.E., Givler, G.A., and Drinker, P.A.,
 Measurement of Boundary Shear Stress in an
 Open Curve Channel with a Surface Pitot Tube:
 M.I.T. Tech. note (no. 6), Aug. 1959

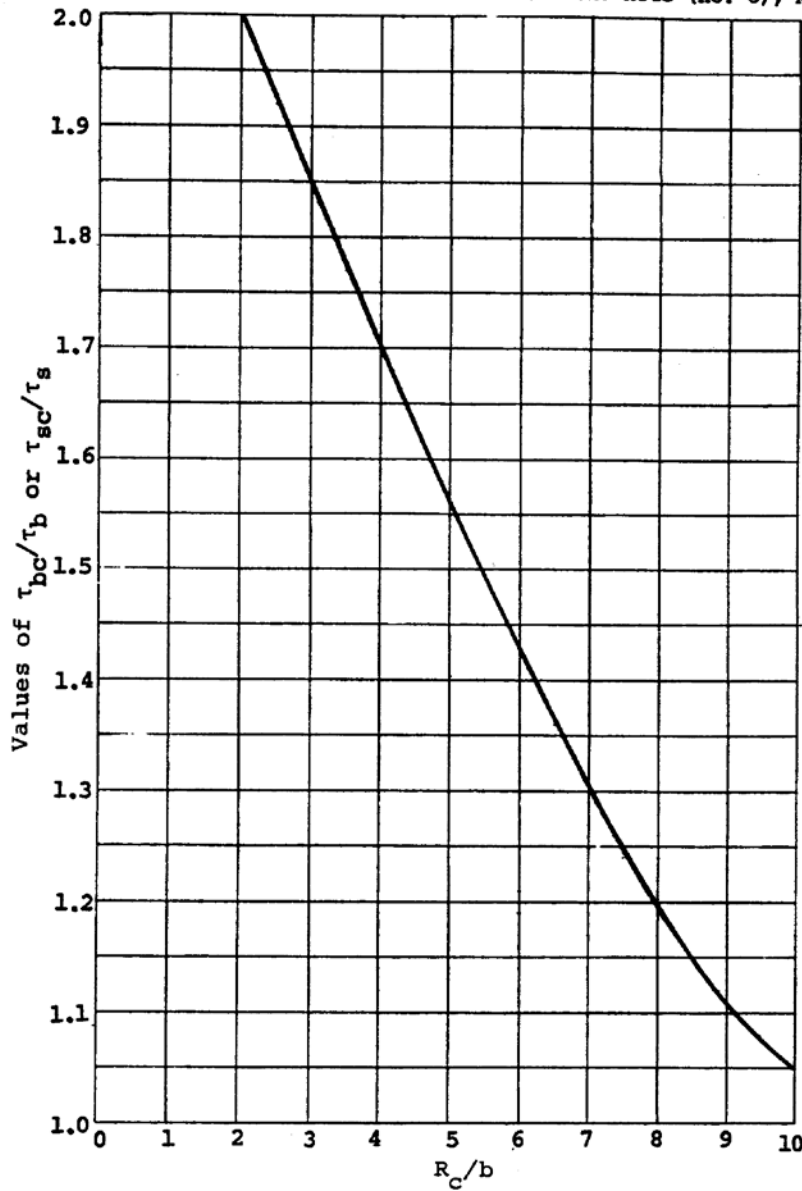

FIGURE A8-4

CHANNEL STABILITY; ACTUAL MAXIMUM TRACTIVE STRESS, τ_{bc} AND τ_{sc} ,
 ON BED AND SIDES OF TRAPEZOIDAL CHANNELS WITHIN A CURVED REACH

REFERENCE

Nece, R.E., Givler, G.A., and Drinker, P.A.,
 Measurement of Boundary Shear Stress in an
 Open Curve Channel with a Surface Pitot
 Tube: M.I.T. Tech note (no.6), Aug. 1959

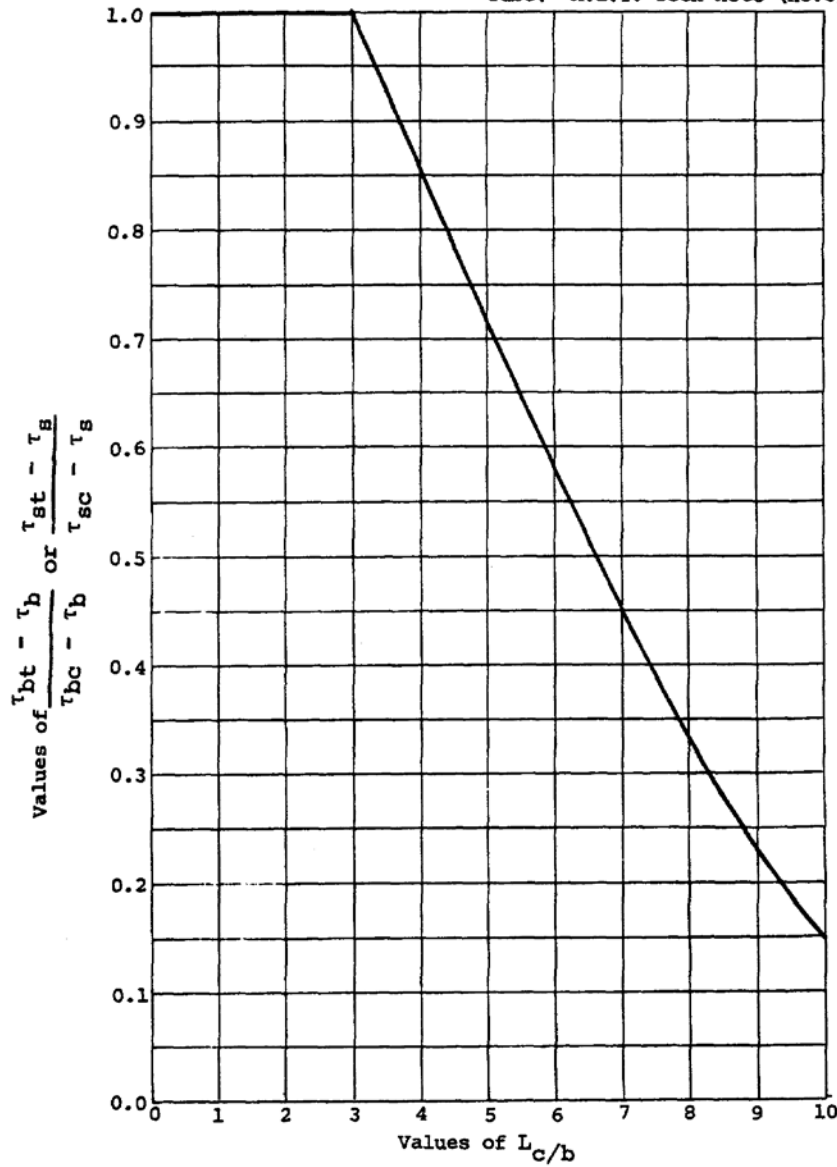

FIGURE A8-5

CHANNEL STABILITY; ACTUAL MAXIMUM TRACTIVE STRESSES τ_{bt} AND τ_{st} ,
 ON BED AND SIDES OF TRAPEZOIDAL CHANNELS IN STRAIGHT REACHES
 IMMEDIATELY DOWNSTREAM FROM CURVED REACHES

REFERENCE
 Bureau of Reclamation Progress Report of
 Results of Studies on Design of Stable
 Channels
 Hyd-352

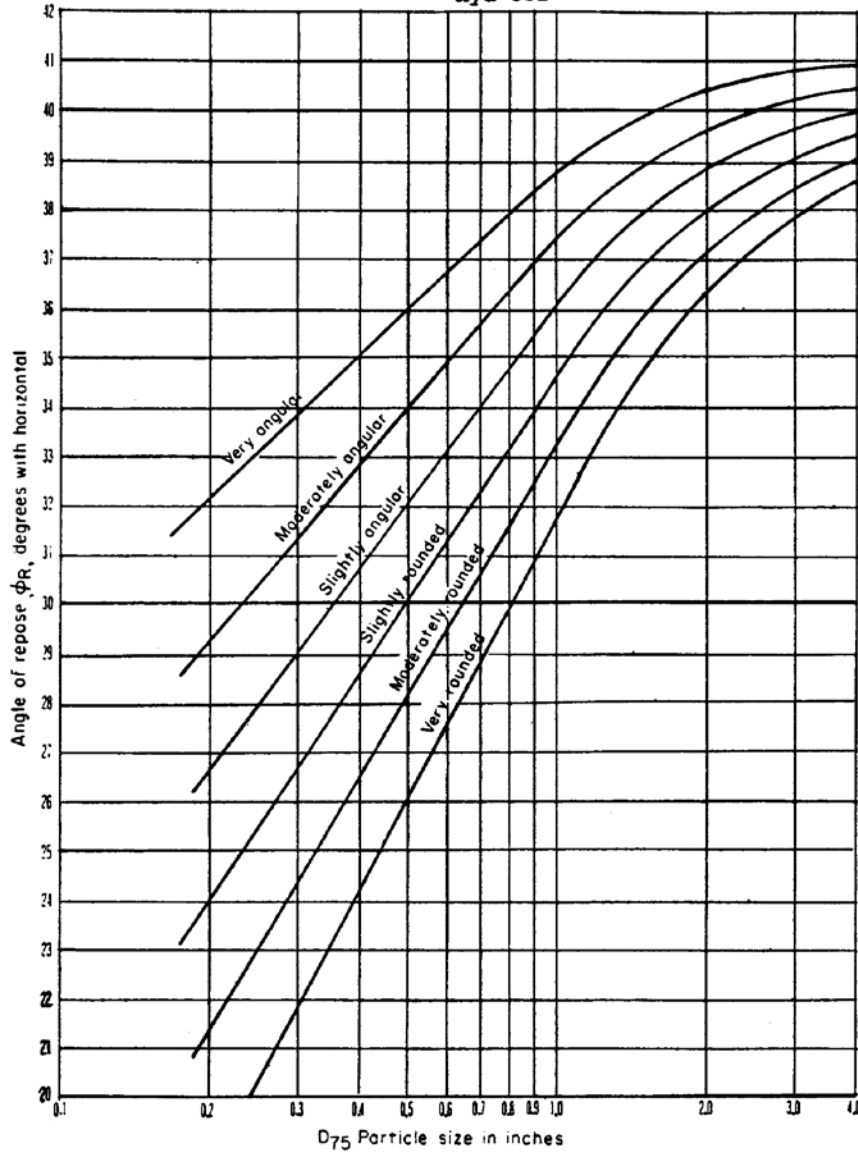

FIGURE A8-6

CHANNEL STABILITY; ANGLE OF RESPOSE, ϕ_R , FOR NON-COHESIVE MATERIALS

REFERENCE:

Bureau of Reclamation "Progress Report
on Results of Studies on Design of
Stables Stable Channels"
Hyd-352

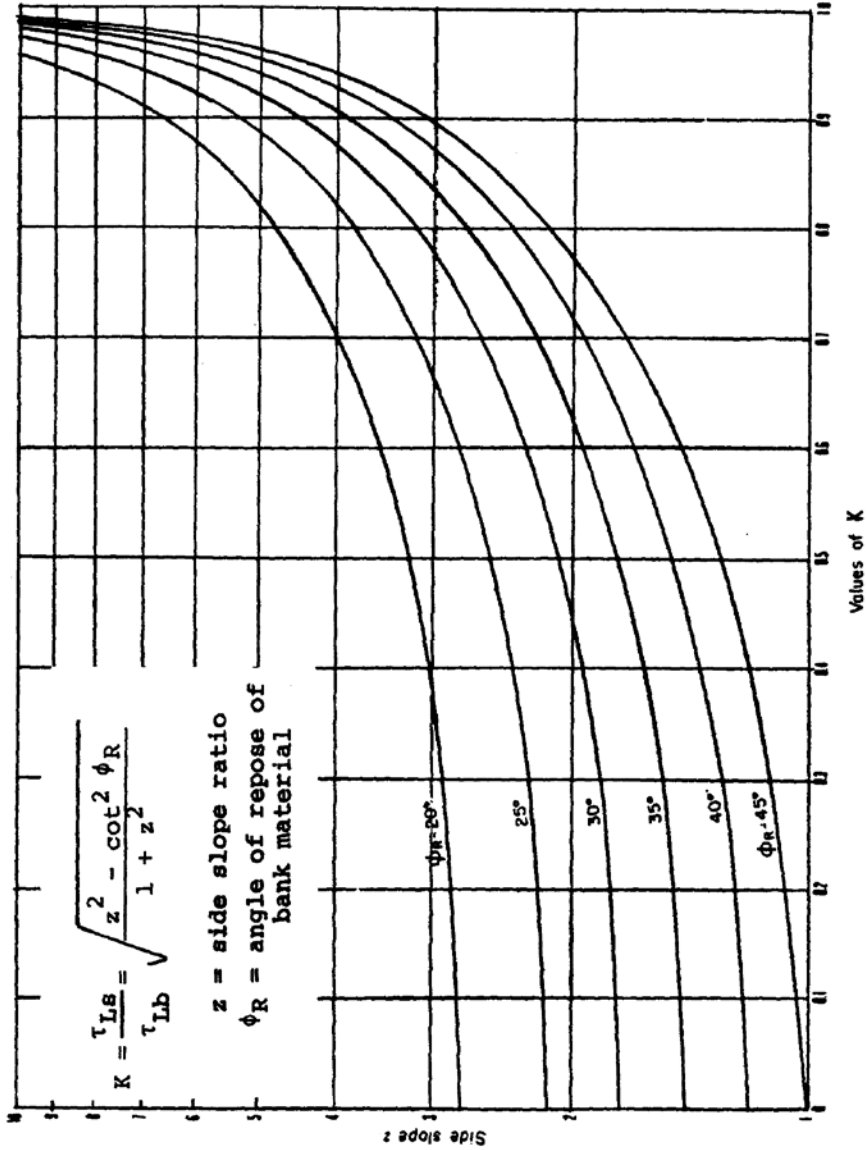

FIGURE A8-7

CHANNEL STABILITY; LIMITING TRACTIVE STRESS τ_{Ls} FOR SIDES OF TRAPEZOIDAL CHANNELS HAVING NON-COHESIVE MATERIALS

In a given situation y and s_e are known so that the only unknown is R_t . The value of R_t can be determined from the logarithmic frictional formula developed by Keulegan and modified by Einstein a4.

$$\frac{v}{\sqrt{gR_t s_e}} = 5.751 \log \left(12.27 \frac{R_t x}{K_s} \right) \quad (\text{Eq. A8-10})$$

where: K_s is the D_{65} size in ft.

The factor x in Equation A8-10 describes the effect on the frictional resistance of the ratio of the characteristic roughness length K_s to the thickness of the laminar sublayer. This thickness is determined from the equation:

$$\delta = \frac{11.6v}{\sqrt{gR_t s_e}} \quad (\text{Eq. A8-11})$$

A relationship between x and K_s/δ has been developed empirically by Einstein a4., and represented by a curve. With the help of this curve and equations A8-10 and A8-11, the value of R_t can be determined provided that V , s_e , K_s and the temperature of the water are known. The computational solution for R_t follows an interactive procedure which is rather involved. A simpler graphical solution has been developed by Vanoni and Brooks a5, and the basic family of curves that constitute it is shown in Figure A8-8. Figure A8-9 shows the extension of the curves outside the region covered in the original publication.

Figure A8-10 gives curves from which values of density and kinematic viscosity of the water can be obtained.

The computation of reference tractive stress (τ) is facilitated by following the procedure on page A8.20.

2. Distribution of the tractive stress along the channel perimeter:

In open channels the tractive stresses are not distributed uniformly along the perimeter. Laboratory experiments and field observations have indicated that in trapezoidal channels the stresses are very small near the water surface and near the corners of the channel and assume their maximum value near the center of the bed. The maximum value on the banks occurs near the lower third point.

The graphs in Figures A8-11 and A8-12 may be used to evaluate maximum stress values on the banks and the bed respectively. These figures are to be used along with τ , the reference tractive stress, to obtain values for the maximum tractive stress on the sides and bed of

trapezoidal channels in fine grained soils.

3. Tractive stresses in curved reaches:

Figures A8-4 and A8-5, used to determine the maximum tractive stresses in curved reaches for coarse grained soils, may also be used to obtain these values for fine grained soils. The values for the maximum tractive stresses on the beds and sides, as determined above, are used in conjunction with these charts to obtain values for curved reaches.

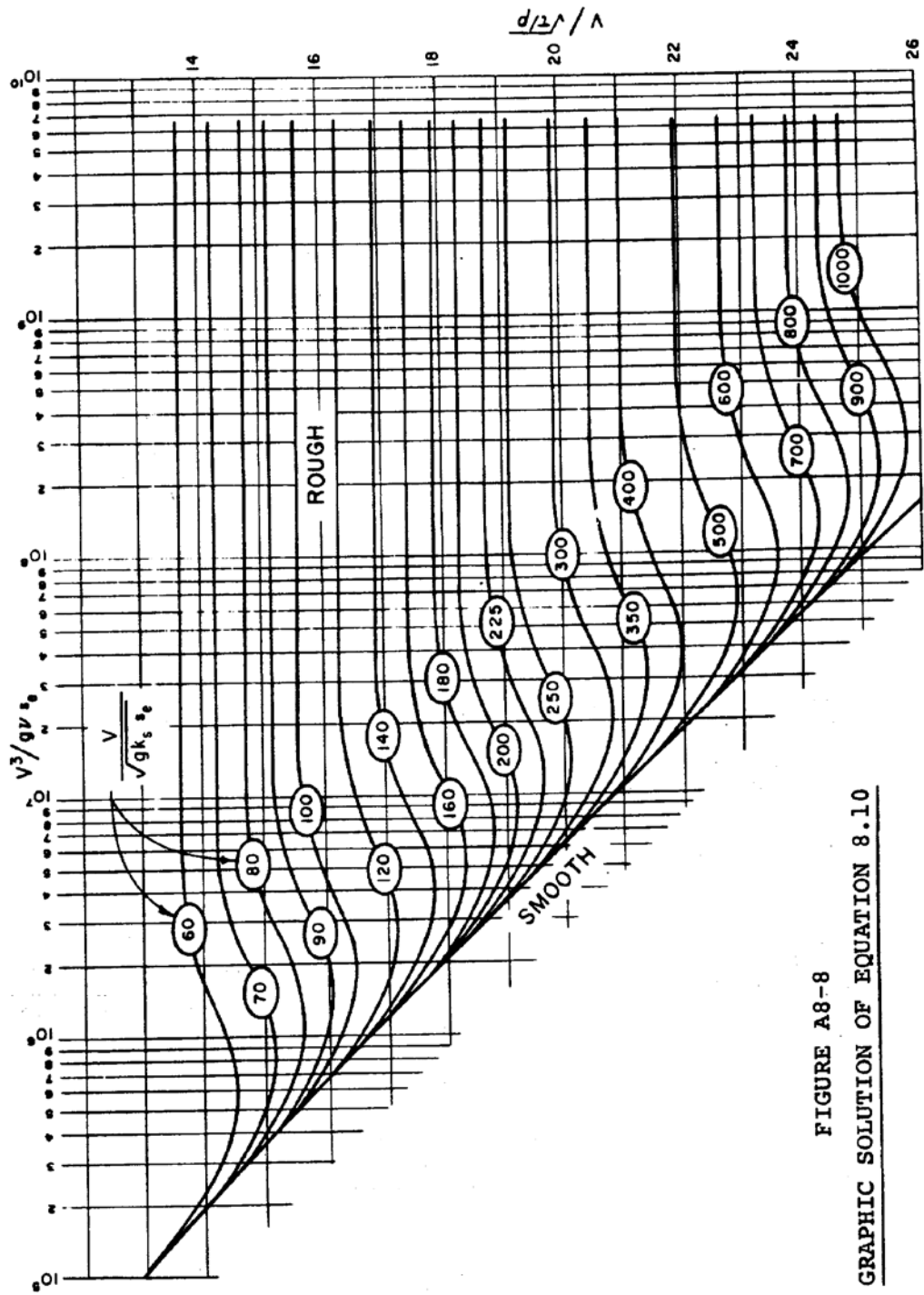

FIGURE A8-8
GRAPHIC SOLUTION OF EQUATION 8.10

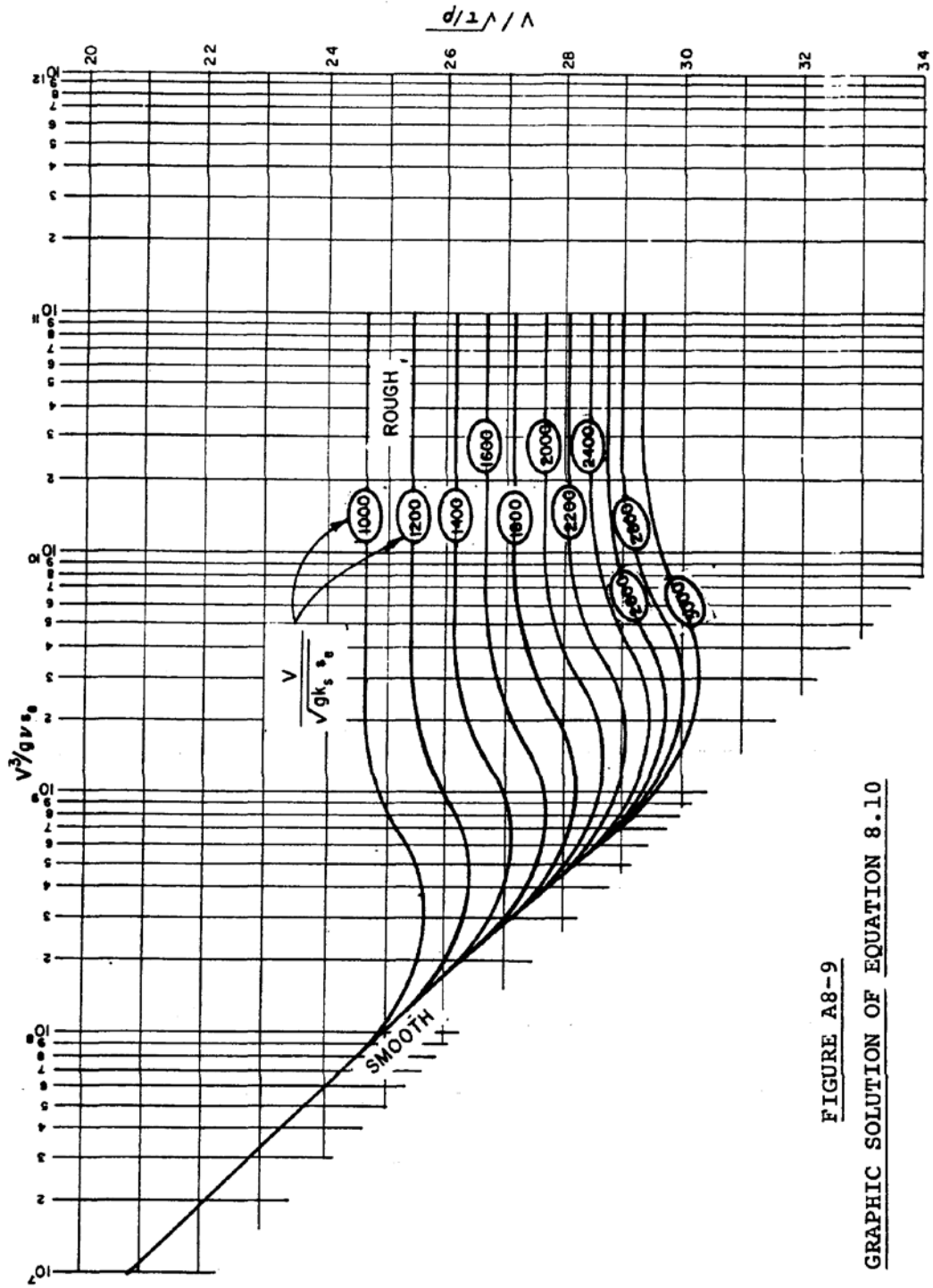

FIGURE A8-9
GRAPHIC SOLUTION OF EQUATION 8.10

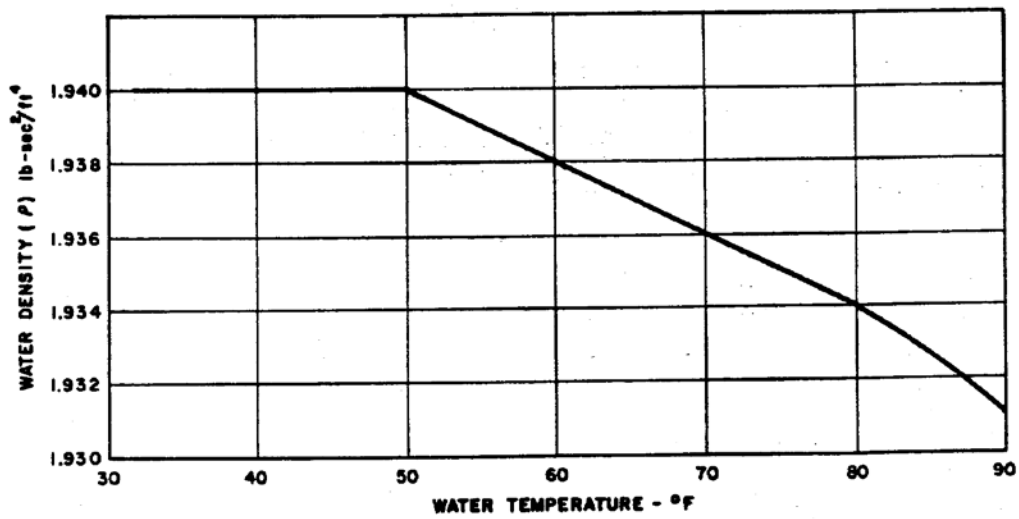
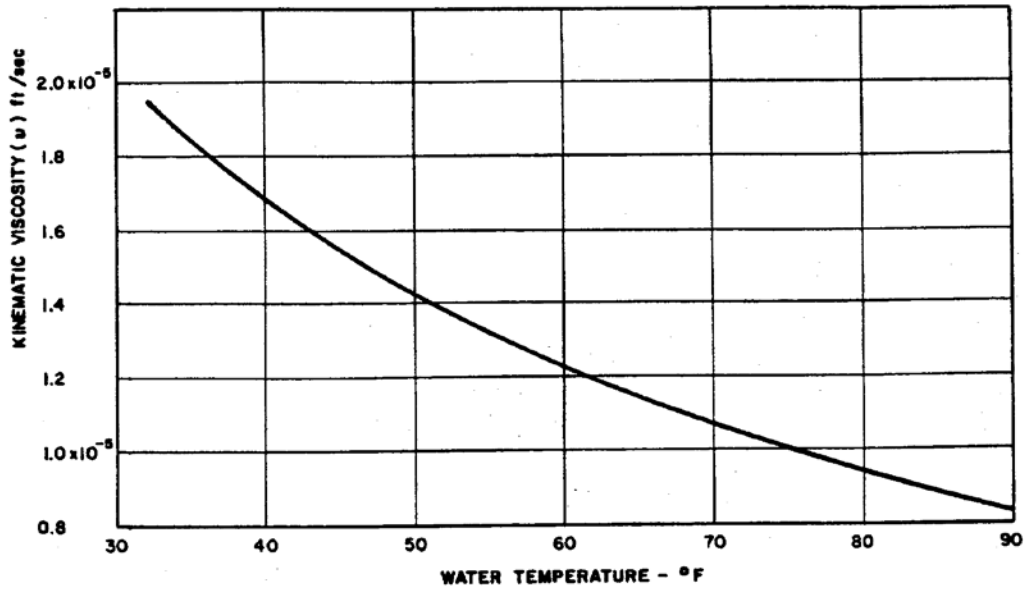

FIGURE A8-10

VALUES OF ρ AND ν FOR VARIOUS WATER TEMPERATURES

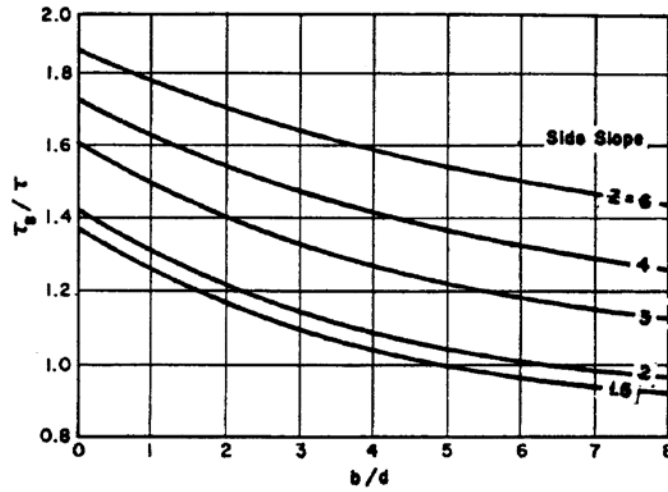

FIGURE A8-11
APPLIED MAXIMUM TRACTIVE STRESS, τ_s ,
ON SIDES OF STRAIGHT TRAPEZOIDAL CHANNELS

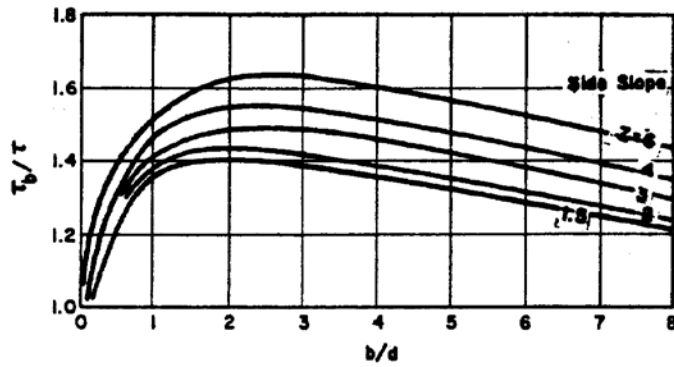

FIGURE A8-12
APPLIED MAXIMUM TRACTIVE STRESS, τ_b ,
ON BED OF STRAIGHT TRAPEZOIDAL CHANNELS

Curves reproduced from "Tentative Design Procedure for Riprap Lined Channels" National Cooperative Highway Research Program Report No. 108

B. Allowable Tractive Stresses - Fine grained soils

The stability of channels in fine grained soils ($D_{75} < 0.25''$) may be checked using the curves in Figure A8-13. These curves were developed by Lane a2. The curves relate the median grain size of the soils to the allowable tractive stress. Curve 1 is to be used when the stream under consideration carries a load of 20,000 ppm by weight or more of fine suspended sediment. Curve 2 is to be used for streams carrying up to 2,000 ppm by weight of fine suspended sediment. Curve 3 is for sediment free flows (less than 1,000 ppm).

When the value of D_{50} for fine grained soils is greater than 5 mm, use the allowable tractive stress values shown on the chart for 5mm.

For values of D_{50} less than those shown on the chart (0.1mm), use the allowable tractive stress values for 0.1 mm. However, if this is done, 0.1 mm should be used as the D_{65} size in obtaining the reference tractive stress.

Procedure - Tractive Stress Approach

The use of tractive stress to check the ability of earth channels to resist erosive stresses involves the following steps:

1. Determine the hydraulics of the channel. This includes hydrologic determinations as well as the stage-discharge relationships for the channel being considered.
2. Determine sediment yield to reach and calculate sediment concentration for design flow, or assume sediment free water.
3. Determine the properties of the earth materials in the boundary of the channel.
4. Check to see if the tractive stress approach is applicable.
5. Compute the tractive stresses exerted by the flowing water on the boundary of the channel being studied. Use the proper procedure as established by the D_{75} size of the materials.
6. Check the ability of the soil materials forming the channel to resist the computed tractive stresses.

The computation for the reference tractive stress for fine grained soils is facilitated by using the following procedure:

1. Determine s_e and V: Evaluate Manning's "n" by the method described in Supplement A.

2. Enter the graphs in Figure A8-10 with the value of temperature in EF and read the density ρ , and the kinematic viscosity of the water ν .
3. Compute $\frac{V^3}{g\tilde{r}+}$
4. Compute $\frac{V}{\sqrt{gk_s S_e}}$
5. Enter the graph in Figure A8-8 (or Figure A8-9) with the computed values in steps 2 and 3 above and read the value of $\frac{V}{\sqrt{\tau_{*}\rho}}$

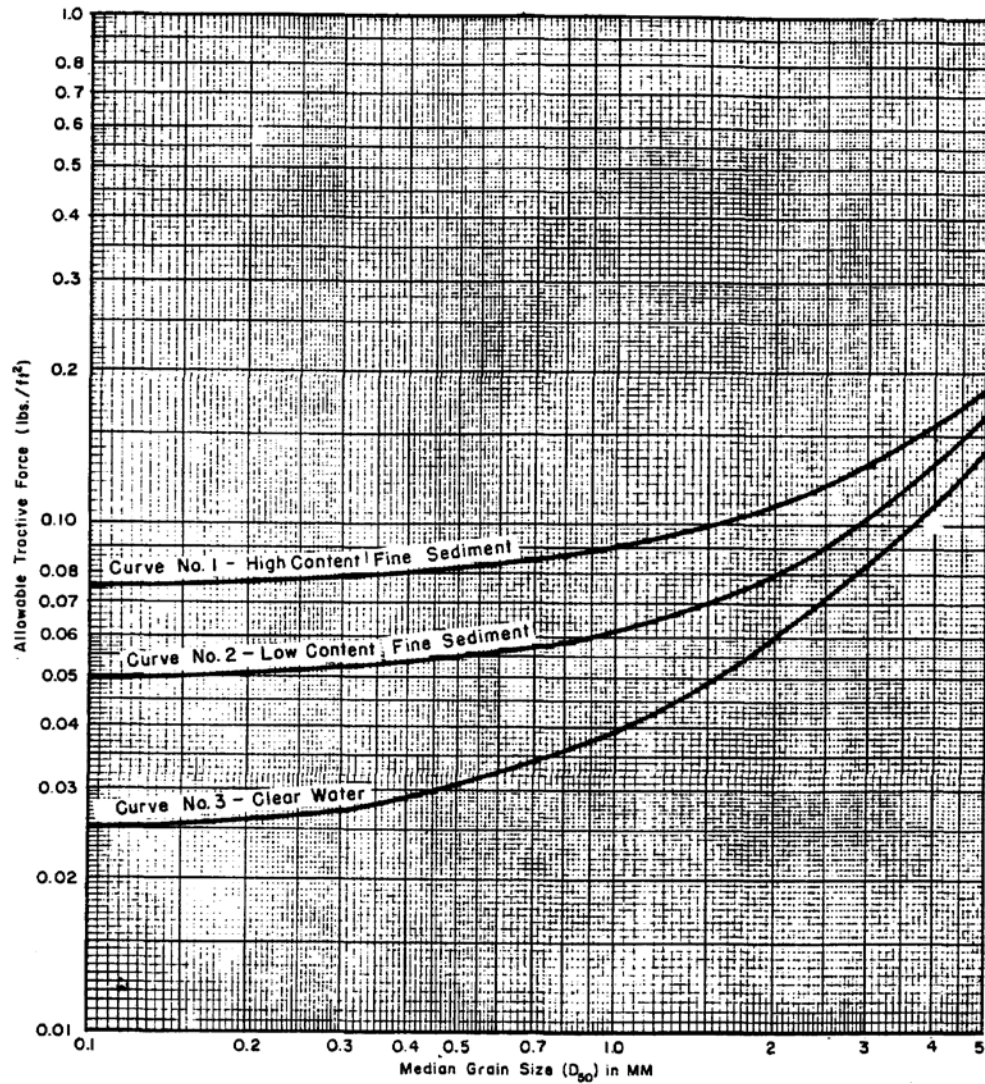

FIGURE A8-13

ALLOWABLE TRACTIVE STRESS -- NON-COHESIVE SOILS, $D_{75} < 0.25''$

REFERENCE: LANE, E. W. "DESIGN OF STABLE CHANNELS", TRANSACTIONS ASCE, VOLUME 120

6. Compute $\frac{v}{\sqrt{\tau/\rho}}$ from v and p

$$\tau = \frac{v^2}{\left(\frac{v}{\sqrt{\tau/\rho}}\right)^2} \quad \text{where the terms are defined in the glossary}$$

Examples - Tractive Stress Approach

Example 3

Given: The bottom width of the trapezoidal channel is 18 feet with side slopes of 1 1/2:1. The design flow is 262 cfs at a depth of 3.5 feet and a velocity of 3.23 fps. The slope of the energy grade line is 0.0026. There is one curve in the reach, with a radius of 150 feet. The aged "n" value is estimated to be 0.045. The channel will be excavated in GM soil that is nonplastic, with $D_{75} = 0.90$ inches (22.0 mm). The gravel is very angular.

Determine: The actual and allowable tractive stress.

Solution: Since $D_{75} > 1/4$ inch use the Lane method.

$$n_t = (0.90)^{1/6}/39 = 0.0252 \quad (\text{Eq. A8-1}).$$

$$\text{From Equation A8-3: } st - (n_t/n)^2 s_e = (0.025/0.045)^2 0.0026 = 0.00082.$$

$$\text{actual } \tau_4 = \gamma_w ds_t = (62.4) (3.5) (0.00082) = 0.179 \text{ psf.}$$

$$b/d \text{ (ratio of bottom width to depth)} = 18/3.5 = 5.14.$$

$$\text{from Figure A4-2 and A4-3 } \tau_s/\tau_4 = 0.76; \quad \tau_b/\tau_4 = 0.98.$$

$$R_c/b \text{ (radius of curve/bottom width)} = 150/18 = 8.33.$$

$$\tau_{bc}/\tau_b = sc/s = 1.17 \text{ (Figure A8-4).}$$

$$\text{Actual } \tau_b = (0.179) (0.98) = 0.175 \text{ psf;}$$

$$\text{actual } \tau_s = (0.179) (0.76) = 0.136 \text{ psf}$$

$$\text{Actual } \tau_{bc} = (0.175) (1.17) = 0.205 \text{ psf;}$$

$$\text{actual } \tau_{sc} = (0.136) (1.17) = 0.159 \text{ psf}$$

Solving for allowable tractive stress -

$$\rho R = 38.4E \text{ (Figure A8-6). } K = 0.45 \text{ (Figure A8-7).}$$

$$\text{allowable: } \tau_{Lb} = (0.4) (D_{75}) = (0.4)(0.90) = 0.36$$

$$\text{allowable: } \tau_{Ls} = 0.4 KD_{75} = (0.4) (0.45) (0.90) = 0.162$$

Comparing actual with allowable, the channel will be stable in straight and curved sections.

Example 4

Given: Bottom width of the trapezoidal section is 18 feet, side slopes are 1-1/2:1. Design flow is 262 cfs, with a depth of 3.5 feet at a velocity of 3.23 fps. Slope of the hydraulic grade line is 0.0026. The design temperature is 50°F. The channel will be cut in nonplastic SM soil, with a D_{75} size of 0.035 inches, a D_{65} size of 0.01075 inches (0.273 mm) and a D_{50} of 0.127 mm. The "n" value for the channel is 0.045. There are no curves in the reach. Sediment load is quite light in this locality, in the range of clear water criteria.

Determine: The actual tractive stress and the allowable tractive stress.

Solution: Since the D_{75} size is less than 1/4 inch, use the reference tractive stress method.

$$v = 1.42 \times 10^{-5} \text{ ft}^2/\text{sec.}, \quad \rho = 1.940 \text{ lb sec}^2/\text{ft}^4 \text{ (Figure A8-10).}$$

$$V^3 / g v s_e = 3.23^3 / (32.2) (1.42 \times 10^{-5}) (0.0026) = 2.83 \times 10^7.$$

$$V / \sqrt{g k_s s_e} = 3.23 / \sqrt{(32.2)(0.01075/12)(0.0026)} = 373$$

$$V / \sqrt{\tau / \rho} = 21.6 \text{ (from Figure A8.8)}$$

$$\tau = V^2 \rho / (V / \sqrt{\tau / \rho})^2 = (3.23^2) 1.94 / (21.6)^2 = 0.0434 \text{ psf.}$$

$$b/d \text{ (ratio of bottom width to depth)} = 18/3.5 = 5.14$$

$$\tau_s / \tau \approx 1.0 \quad \tau_b / \tau = 1.31 \text{ (from Figure A8-11 and A8-12).}$$

Actual Tractive Stresses:

$$\tau_s = (0.0434) (1.0) = 0.0434 \text{ psf; } \quad \tau_b = (0.0434) (1.31) = 0.0569 \text{ psf}$$

Allowable Tractive Stresses:

$D_{50} = 0.127$ mm; from Figure A4-13 and assuming clear water flow (curve No.3) the allowable tractive force is 0.025 psf. Both the bed and the banks of the channel are unstable.

GLOSSARY OF SYMBOLS

- A - alignment factor to adjust the basic velocity because of the effects of curvature of the channel.
- A - area of flow. (ft²)
- b- bottom width of a channel (feet).
- b_T - water surface width (feet).
- B - bank slope factor to adjust the basic velocity because of the effects of different bank slopes.
- C - sediment concentration in parts per million by weight.
- C₁, C₂, C₃, C₄, C₅ -coefficients used to determine channel proportions and slope when using the modified regime equations.
- C_e - Density factor to adjust the basic velocity because of variations in the density of soil materials in the channel boundary.
- c_m - cohesion intercept at natural moisture (psf).
- d- depth of flow (feet).
- d_c - critical depth of flow (feet).
- d_m - mean depth of flow (feet).
- D - depth factor to adjust basic velocity because of the effects of the depth flow.
- D_s - the particle diameter of which s% of the sample is smaller.
- F- frequency factor to adjust the basic velocity because of the effect of infrequent flood flows.
- F- Froude number =
$$\frac{V}{\sqrt{gd_m}}$$
- g- acceleration due to gravity (fps²).
- G - specific gravity.
- H_c - depth of tension crack (feet).
- k_s - characteristic length of roughness element, for granular material; K_s = D₆₅ size in feet.
- K - coefficient modifying tractive force for gravitational forces on coarse, noncohesive materials on channel sides.
- n - Manning's coefficient.
- n_t - Manning's coefficient for roughness of soil grains.

P	-	wetted perimeter.
P _I	-	Plasticity index.
q _u	-	unconfined compressive strength.
Q	-	discharge (cfs).
Q _s	-	Sediment transport rate (tons/day)
R	-	hydraulic radius - feet.
R _c	-	radius of curvature of central section of compound curve.
R _t	-	hydraulic radius associated with grain roughness of the soil.
s _o	-	slope of channel bottom.
s _c	-	critical slope.
s _e	-	energy gradient
s _t	-	rate of friction head loss because of tractive stress acting on bed and side materials.
V	-	average velocity (fps).
V _a	-	allowable velocity (fps).
v _b	-	basic velocity (fps).
V _c	-	critical velocity (fps).
W _T	-	top width of flow - ft.
x	-	factor describing effect of ratio $\frac{k_s}{\delta}$ on flow resistance.
z	-	cotangent of side slope angle.
T	-	factor to correct allowable tractive force for materials with D ₇₅ > 0.25" for unit weights different than 160 pcf.
γ _d	-	unit weight of water (pcf).
γ	-	dry unit weight (pcf).
γ _m	-	moist unit weight (pcf).
γ _s	-	unit weight of particles larger than 0.25" (pcf).
γ _w	-	unit weight of water (62.4 pcf).

- δ - thickness of laminar sublayer = $\frac{11.6v}{\sqrt{gR_f s_e}}$
- ϕ - angle of shearing resistance.
- ϕ_m - angle of shearing resistance at natural moisture content.
- ϕ_r - angle of repose of coarse noncohesive materials.
- ν - kinematic viscosity of water (ft²/sec).
- ρ - water density (lb-sec²/ft⁴).
- T - reference tractive stress (psf).
- τ_4 - tractive stress in an infinitely wide channel (psf).
- τ_b - maximum tractive stress on the channel bed (psf).
- τ_s - maximum tractive stress on the channel sides (psf).
- τ_{bc} - maximum tractive stress on the bed in a curved reach (psf).
- τ_{sc} - maximum tractive stress on the sides in a curved reach (psf).
- τ_{Lb} - allowable tractive stress along the bed. (psf)
- τ_{Ls} - allowable tractive stress along the sides (psf).

SUPPLEMENT A

Method for Estimating Manning's "n"

This supplement describes a method for estimating the roughness coefficient "n" for use in hydraulic computations associated with natural streams, floodways and similar streams. The procedure proposed applies to the estimation of n in Manning's formula. This formula is now widely used, it is simpler to apply than other widely recognized formulas and has been shown to be reliable.

Manning's formula is empirical. The roughness coefficient "n" is used to quantitatively express the degree of retardation of flow. The value of "n" indicates not only the roughness of the sides and bottom of the channel, but also other types of irregularities of the channel and profile. In short, "n" is used to indicate the net effect of all factors causing retardation of flow in a reach of channel under consideration.

There seems to have developed a tendency to regard the selection of "n" for natural channels as either an arbitrary or an intuitive process. This probably results from the rather cursory treatment of the roughness coefficient in most of the more widely used hydraulic textbooks and handbooks. The fact is that the estimation of "n" requires the exercise of critical judgment in the evaluation of the surfaces of the channel sides and bottom; variations in shape and size of cross sections; obstructions; vegetation; and meandering of the channel.

The need for realistic estimates of "n" justifies the adoption of a systematic procedure for making the estimates.

Procedure for estimating n. The general procedure for estimating "n" involves; first, the selection of a basic value of "n" for a straight, uniform, smooth channel in the natural materials involved; then, through critical consideration of the factors listed above, the selection of a modifying value associated with each factor. The modifying values are added to the basic value to obtain "n" for the channel under consideration.

In the selection of the modifying values associated with the 5 primary factors, it is important that each factor be examined and considered independently. In considering each factor, it should be kept in mind that represents a quantitative expression of retardation of flow. Turbulence of flow can, in a sense, be visualized as a measure or indicator of retardance. Therefore, in each case, more critical judgment may be exercised if it is recognized that as conditions associated with any factor change so as to induce greater turbulence, there should be an increase in the modifying value. A discussion and tabulated guide to the selection of modifying values for each factor is given under the following procedural steps.

1st step. Selection of basic "n" value. This step requires the selection of a basic "n" value for a straight, uniform, smooth channel in the natural materials involved. The selection involves consideration of what may be regarded as a hypothetical channel. The conditions of straight alignment, uniform cross section, and smooth side and bottom surfaces without vegetation should be kept in mind. Thus, the basic "n" will be visualized as varying only with the materials forming the sides and bottom of the channel. The minimum values of "n" shown by reported test results for the best channels in earth are in the range from 0.016 to 0.018. Practical limitations associated with maintaining smooth and uniform channels in earth for any appreciable period indicated that 0.02 is a realistic basic "n". The basic "n", as it is intended for use in this procedure, for natural or excavated channels, may be selected from the table below. Where the bottom and sides of a channel are of different materials, this fact may be recognized in selecting the basic "n".

CHARACTER OF CHANNEL	<u>BASIC n</u>
Channels in earth	0.02
Channels cut into rock	0.025
Channels in fine gravel	0.024
Channels in coarse gravel	0.028

2nd step. Selection of modifying value for surface irregularity. The selection is to be based on the degree of roughness or irregularity of the surfaces of channel sides and bottom. Consider the actual surface irregularity; first, in relation to the degree of surface smoothness obtainable with the natural materials involved, and second, in relation to the depths of flow under consideration. Actual surface irregularity comparable to the best surface to be expected of the natural materials involved calls for a modifying value of zero. Higher degrees of irregularity induce turbulence and call for increased modifying values. The table below may be used as a guide to the selection.

<u>DEGREE OF IRREGULARITY</u>	<u>SURFACES COMPARABLE TO</u>	<u>MODIFYING VALUE</u>
Smooth	The best obtainable for the materials involved.	0.000
Minor	Good dredge channels; slightly eroded or scoured side slopes of canals or drainage channels.	0.005
Moderate	Fair to poor dredged channels; moderately sloughed or eroded side slopes of canals or drainage channels.	0.010
Severe	Badly sloughed banks of natural channels; badly eroded or sloughed sides of canals or drainage channels; unshaped, jagged and irregular surfaces of channels excavated in rock.	0.020

3rd step. Selection of modifying value for variations in shape and size of cross sections. In considering changes in size of cross sections, judge the approximate magnitude of increase and decrease in successive cross sections as compared to the average. Changes of considerable magnitude, if they are gradual and uniform, do not cause significant turbulence. The greater turbulence is associated with alternating large and small sections where the changes are abrupt. The degree of effect of size changes may be best visualized by considering it as depending primarily on the frequency with which large and small sections alternate, and secondarily on the magnitude of the changes.

In the case of shape variations, consider the degree to which the changes cause the greatest depth of flow to move from side to side of the channel. Shape changes causing the greatest turbulence are those for which shifts of the main flow from side to side occur in distances short enough to produce eddies and upstream currents in the shallower portions of those sections where the maximum depth of flow is near either side. Selection of modifying values may be based on the following guide:

<u>CHARACTER OR VARIATIONS IN SIZE AND SHAPE OF CROSS SECTIONS</u>	<u>MODIFYING VALUE</u>
Changes in size or shape occurring gradually	0.000
Large and small sections alternating occasionally or shape changes causing	

occasional shifting of main flow from side to side	0.005
Large and small sections alternating frequently or shape changes causing frequent shifting of main flow from side to side	0.010 to 0.015

4th step. Selection of modifying value for obstructions. The selection is to be based on the presence and characteristics of obstructions such as debris deposits, stumps, exposed roots, boulders and fallen and lodged logs. Care should be taken that conditions considered in other steps are not re-evaluated or double-counted by this step.

In judging the relative effect of obstructions, consider: the degree to which the obstructions occupy or reduce the average cross sectional area at various stages; the character of obstructions (sharp-edged or angular objects induce greater turbulence than curved, smooth-surfaced objects); the position and spacing of obstructions transversely and longitudinally in the reach under consideration. The following table may be used as a guide to the selection.

<u>RELATIVE EFFECT OF OBSTRUCTIONS</u>	<u>MODIFYING VALUE</u>
Negligible	0.000
Minor	0.010 to 0.015
Appreciable	0.020 to 0.030
Severe	0.040 to 0.060

5th step. Selection of modifying value for vegetation. The retarding effect of vegetation is probably due primarily to the turbulence induced as the water flows around and between the limbs, stems and foliage, and secondarily to reduction in cross section. As depth and velocity increase, the force of the flowing water tends to bend the vegetation. Therefore, the ability of vegetation to cause turbulence is partly related to its resistance to bending force. Furthermore, the amount and character of foliage; that is, the growing season condition versus dormant season condition is important. In judging the retarding effect of vegetation, critical consideration should be given to the following: the height in relation to depth of flow; the capacity to resist bending; the degree to which the cross section is occupied or blocked out; the transverse and longitudinal distribution of vegetation of different types, densities and heights in the reach under consideration. The following table may be used as a guide to the selection:

<u>VEGETATION AND FLOW CONDITIONS COMPARABLE TO:</u>	<u>DEGREE OF EFFECT ON n</u>	<u>RANGE IN MODIFYING VALUE</u>
Dense growths of flexible turfgrasses or weeds, of which Bermuda and bluegrasses are examples, where the average depth of flow is 2 to 3 times the height of vegetation.	Low	0.005 to 0.010
Supple seedling tree switches such as willow, cottonwood or salt cedar where the average depth of flow is 3 to 4 times the height of the vegetation.		
Turf grasses where the average depth of flow is 1 to 2 times the height of vegetation.		
Stemmy grasses, weeds or tree seedlings with moderate cover where the average depth of flow is 2 to 3 times the height of vegetation	Medium	0.010 to 0.025
Brushy growths, moderately dense, similar to willows 1 to 2 years old, dormant season, along side slopes of channel with no significant vegetation along the channel bottom, where the hydraulic radius is greater than 2 feet.		
Turf grasses where the average depth of flow is about equal to the height of vegetation.		
Dormant season, willow or cotton wood trees 8 to 10 years old, inter grown with some weeds and brush, none of the vegetation in foliage, where the hydraulic radius is greater than 2 feet.	High	.025 to 0.050
Growing season, bushy willows about 1 year old intergrown with some weeds in full foliage along side slopes, no significant vegetation along channel bottom, where hydraulic radius is greater than 2 feet.		

Turf grasses where the average depth of flow is less than one half the height of vegetation.

Growing season, bushy willows about 1 year old, intergrown with weeds in full foliage along side slopes; dense growth of cattails along channel bottom; any value of hydraulic radius up to 10 to 15 feet.

Very High 0.050 to 0.100

Growing season; trees intergrown with weeds and brush, all in full foliage, any value of hydraulic radius up to 10 to 15 feet .

6th step. Determination of the modifying value for meandering of channel. The modifying value for meandering may be estimated as follows: Add the basic "n" for Step 1 and the modifying values of Steps 2 through 5 to obtain the subtotal of n_s .

Let s = the straight length of the reach under consideration.

m = the meander length of the channel in the reach.

Compute modifying value for meandering in accordance with the following Table:

<u>Ratio (m/ s)</u>	<u>Degree of meandering</u>	<u>Modifying value</u>
1.0 to 1.2	Minor	0.000
1.2 to 1.5	Appreciable	0.15 n_s
1.5 and greater	Severe	0.30 n_s

Where lengths for computing the approximate value of m/s are not readily obtainable, the degree of meandering can usually be judged reasonably well.

7th step. Computation of "n" for the reach. The value of "n" for the reach is obtained by adding the values determined in Steps 1 through 6. An illustration of the estimation of "n" is given in Example 1.

Example 1. Estimation of n for a reach.

This example is based on a case where "n" has been determined so that comparison between the estimated and actual "n" can be shown.

Channel: Camp Creek dredged channel near Seymour, Illinois; see USDA Technical Bulletin No 129, Plate 29-C for photograph and Table 9, page 86, for data.

Description: Course straight; 661 feet long. Cross section, very little variation in shape; variation in size moderate, but changes not abrupt. Side slopes fairly regular, bottom uneven and irregular. Soil, lower part yellowish gray clay; upper part, light gray silty clay loam. Condition, side slopes covered with heavy growth of poplar trees 2 to 3 inches in diameter, large willows and climbing vines; thick growth of water weed on bottom;

summer condition with vegetation in full foliage.

Average cross section approximates a trapezoid with side slopes about 1.5 to 1 and bottom width about 10 feet. At bankfull stage, average depth and surface width are about 8.5 and 40 feet respectively.

<u>STEP</u>	<u>REMARKS</u>	<u>MODIFYING VALUES</u>
1	Soil materials indicate minimum basic n.	0.02
2	Description indicates moderate irregularity.	0.01
3	Changes in size and shape judged insignificant.	0.00
4	No obstructions indicated.	0.00
5	Description indicates very high effect of vegetation.	0.08
6	Reach described as straight.	<u>0.00</u>
	Total estimated n	0.11

USDA Technical Bulletin No. 129, Table 9, page 96, give the following determined values for NJDOT for this channel: for average depth of 4.6 feet "n" = 0.095; for average depth of 7.3 feet n = 0.104.

Appendix A-9

Modified Rational Method

The Soil Conservation Service Technical Release No. 55, (TR-55), Urban Hydrology for Small Watersheds, methodology can determine peak flows from areas of up to five (5) square miles, provide a hydrograph for times of concentration of up to 2 hours, and estimate the required storage for a specified outflow. However, there is another method which can estimate peak flows and the required storage. For small drainage areas up to one-half square mile, the Rational Method ($Q=CIA$, where Q is the runoff in cfs, " I " is the intensity of rainfall in inches/hour for the time of concentration of the drainage area, A is the area in acres, and C is a dimensionless runoff coefficient) can determine the peak flow rate only. The Modified Rational Method (MRM) as discussed in the American Public Works Association's Special Report 43, can give an approximate storage volume and triangular and trapezoidal hydrographs. This method is applicable for uniform areas up to twenty (20) acres.

THEORY

The area under a hydrograph equals the volume of runoff. For the Modified Rational Method, this area is equal to the peak discharge rate times the duration of the storm. A uniform rainfall intensity for the entire rainfall period is assumed here. This is highly unlikely.

The MRM recommends that a coefficient be used in order to account for the antecedent moisture conditions of storms greater than those with a twenty-five (25) year recurrence intensity ($Q=ca \times c \times i \times a$). This attempts to predict a more realistic runoff volume which is characteristic of higher frequency storms. The maximum product of $ca \times c$ cannot be greater than one.

Recommended Antecedent Precipitation
Factors for the Rational Method

Recurrence Interval (years)	ca
2 to 10	1.0
25	1.1
50	1.2
100	1.25

The time of concentration (t_c), which is the time of travel from the most remote point (in time of flow), determines the largest peak discharge. Therefore, there are two possible approximate hydrographs that can be used for runoff and storage requirements.

FIRST CASE: If the rainfall duration is greater than the t_c , then the approximate hydrograph is a trapezoid.

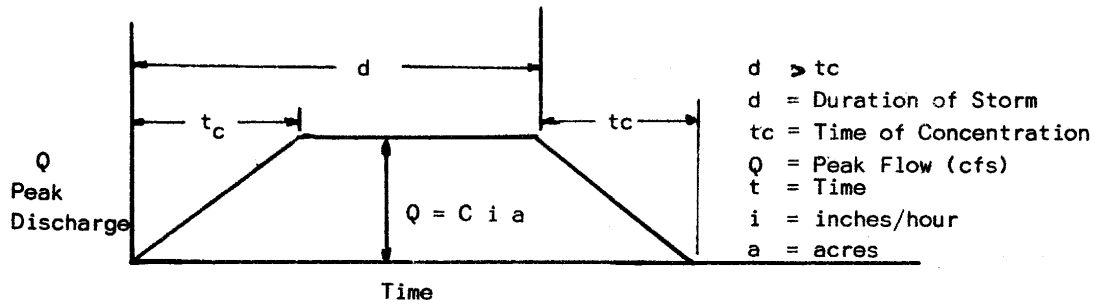

SECOND CASE If the rainfall duration is equal to the time of concentration (assuming the t_c is the same as in the first case), then the approximate hydrograph is a triangle.

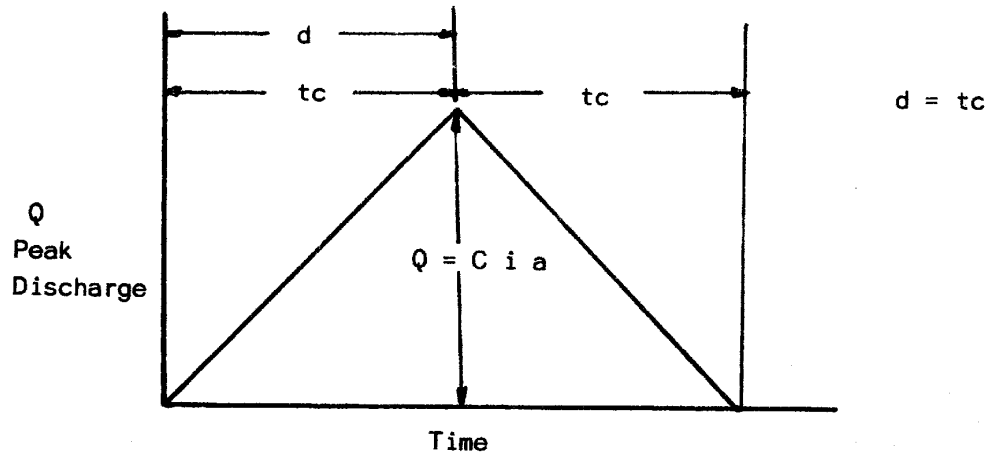

To find the required volume, the MRM uses a trial method to find the critical storage for a given drainage area. For instance, the peak rate for a 25 year storm is the product of the runoff coefficient times the drainage area in acres times the intensity of a 25 year storm for a given time of concentration. However, the critical storage volume may be that of a different duration.

There are three steps in the MRM. The first step is to collect the physical data for the drainage area. This is the drainage area, the time of concentration, the runoff coefficient, and the allowable release rate. The second step is to obtain the proper recurrence interval for the design storm and the intensity-duration relationship for the design frequency. Then calculate a series of peak flows and runoff volumes beginning with the time of concentration of the drainage area and for increased storm durations. The third step is to compute the release volume and the required storage until the maximum or critical storage is found.

EXAMPLE

First Step. A site to be developed has a ground cover of forest with light underbrush. The soil type for the site is Evesboro soil (sand), hydrologic soil group A. The predeveloped site drains into two drainage areas. The southern portion consists of 6.39 acres. The northern portion consists of 8.07 acres. In order to minimize the effect of increased storm water runoff downstream, possibly resulting in soil erosion and sedimentation damage, an onsite detention basin is proposed for the developed condition. Grading of the site will cause the southern drainage area to increase to 11.88 acres. Since the NJDEP curves do not contain the 2 year frequency, the intensity-duration curves for New York City were used in the analysis. A summary of the times of concentration and drainage areas is as follows:

Southern Portion

Storm (years)	Predeveloped Condition					Postdeveloped Condition				
	Acres	tc	C	I	Q	Acres	tc	C	I	Q
2	6.39	0.35	0.22	2.5	4.4	11.88	0.25	0.7	2.9	24
10	6.39	0.35	0.22	4.0	7.1	11.88	0.25	0.7	4.7	39

where tc is hours, i is inch/hour, and Q is cfs .

Second step. Stability is demonstrated offsite by analyzing the velocity for storm water runoff for the two and ten year storms over a defined waterway. These frequencies are chosen because of their high probability of occurrence. Outflow from a detention basin must meet the Conduit Outlet Protection (pg. 12-1), Slope Protection (pg. 27-1), and Channel Stabilization (pg. 11-1) Standards. Stability to the point of discharge to a stream or body of water should be shown in all cases. In this example it was assumed that it was not possible to obtain a drainage easement to accomplish this and therefore the discharge from the proposed outlet at the detention basin must match the predevelopment peak flow at that point. The allowable release rate is therefore the predevelopment peak flow for the 2 and 10 year frequency storms at the proposed point of discharge.

$$tc = 10 \text{ minutes}$$

$$C = 0.18 \text{ for the predeveloped drainage area at that point of future discharge}$$

$$a = 0.93 \text{ acres (not 8.07 acres)}$$

$$i = 5.5 \text{ inches per hour (10 year frequency)}$$

$$Q = C \times i \times a$$

$$= 0.18 \times 5.5 \times 0.93$$

= 0.92 cfs predevelopment peak at the point of discharge which is the allowable release rate.

Third step. Construct a series of hydrographs for each selected duration of the storm as shown in figure A9.1, Modified Rational Method Hydrographs. The estimated critical storage for this site is 88,858 cubic feet. Since the inflow volume must equal the outflow volume of 98,794 cubic feet, the time to the end of the release rate is 30.3. To reach zero outflow approximately 0.5 hours must be added so the total dewatering time will be about 30.3 hours. The outflow hydrograph reaches maximum flow at the intersection with the falling limb of the hydrograph resulting from a storm with a duration equal to the time of concentration.

Table A9.2

Storage-Duration Values

Duration of Storm (hr) (1)	Intensity I (in/hr) (2)	Peak Flow Q (cfs) (3)	Volume of Runoff (cuft) (4)	Release Flow Volume (cuft) (5)	Required Storage Volume (cuft) (6)
0.25	4.8	39.9	35,925	828	35,097
0.50	3.4	28.3	50,894	1,656	49,238
0.75	2.7	22.5	60,624	2,484	58,140
1.00	2.3	19.1	68,856	3,312	65,544
1.50	1.7	14.1	76,341	4,968	71,373
2.00	1.4	11.6	83,825	6,624	77,201
3.00	1.1	9.1	98,794	9,936	88,858 << Maximum Storage Volume Required
3.50	0.9	7.5	94,303	11,592	82,711

Column (3) Peak Flow = $Q = c i a$
example : $0.7 \times 4.8 \times 11.88 = 39.9$ cfs

Column (4) Runoff Volume = Q (col 3) X Duration of Storm
(col. 1) X 3600
example : 39.9 cfs X 0.25 hrs X $3600 = 35,925$ cuft

Column (5) Release Volume = 0.92 cfs X Duration of Storm
(col. 1) X 3600
example : $0.92 \times 0.25 \times 3600 = 828$ cuft

Column (6) Required Storage = Runoff Volume (col. 4) - Release Volume (col 5)
example : $35,925 - 828 = 35,097$

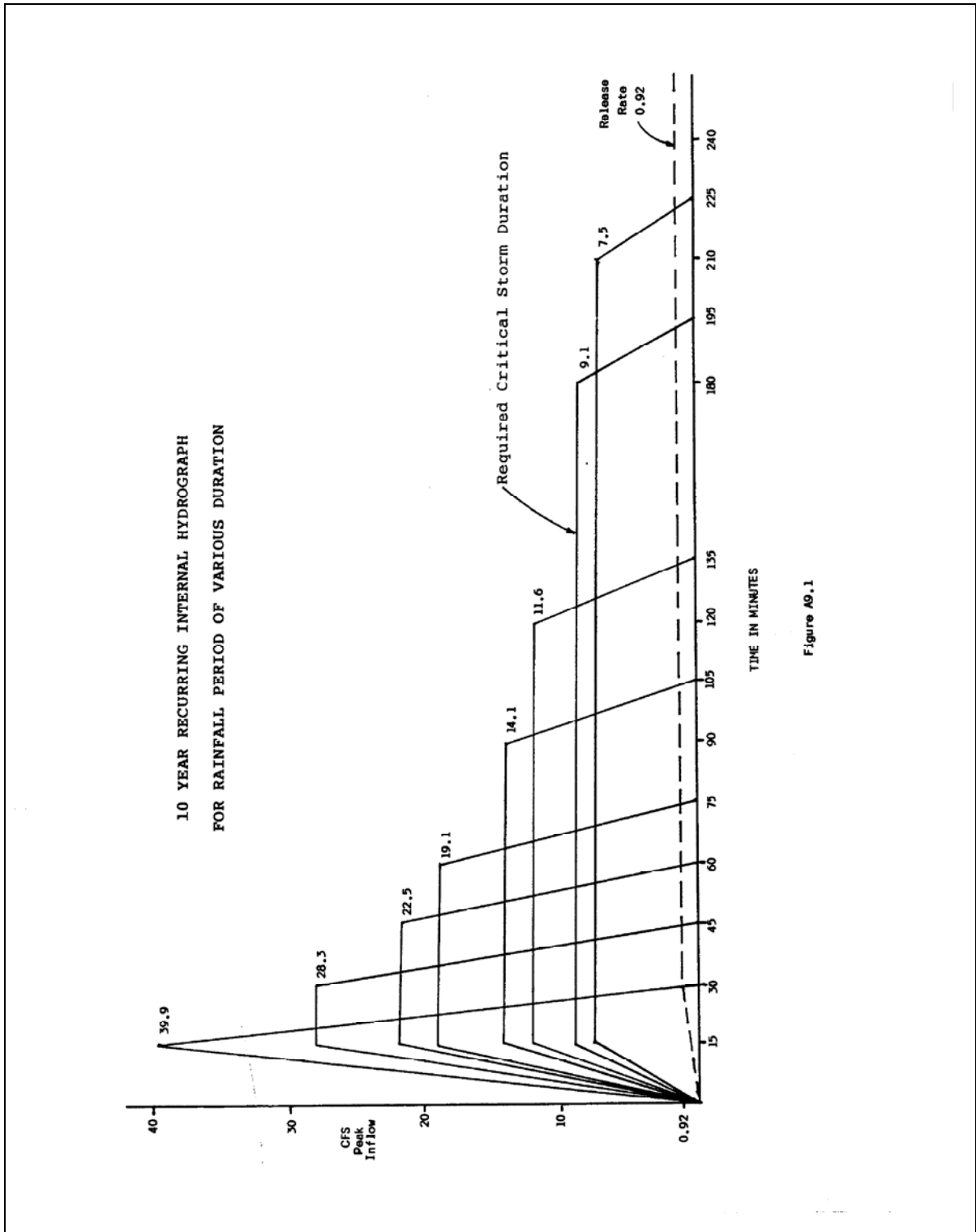

Figure A9.1

APPENDIX A10

Modified Structural Guidelines for Stormwater Management Basins
Natural Resource Conservation Service
Pond Standard No. 378

Definition:

A water impoundment made by constructing a dam or embankment or by excavating a pit or dugout.

In this standard, ponds constructed by the first method are referred to as embankment ponds, and those constructed by the second method are referred to as excavated ponds. Ponds constructed by both the excavation and the embankment methods are classified as embankment ponds if the depth of water impounded against the embankment at spillway elevation is 3 feet or more.

Purpose

To provide water for livestock, fish and wildlife, recreation, fire control, crop and orchard spraying, and other related uses, and to maintain or improve water quality.

Scope

This standard establishes the minimum acceptable quality for the design and construction of ponds if:

1. Failure of the dam will not result in the loss of life; in damage to homes, commercial or industrial buildings, main highways, or railroads; or in interruptions of the use or service of public utilities.
2. The product of the storage times the effective height of the dam is less than 3,000. Storage is the volume, in acre-feet, in the reservoir below the elevation of the crest of the emergency spillway. The effective height of the dam is the difference in elevation, in feet, between the emergency spillway crest and the lowest point in the cross section taken along the centerline of the dam. If there is no emergency spillway, the top of the dam is the upper limit.
3. The effective height of the dam is 35 feet or less and the dam is hazard class "a" (Low hazard).

Conditions Where Practice Applies

Site Conditions. Site conditions shall be such that runoff from the design storm can be safely passed through (1) a natural or constructed emergency spillway, (2) a combination of a principal spillway and the emergency spillway or (3) a principal spillway.

Drainage Area. The drainage area above the pond must be protected against erosion to the extent that expected sediment will not shorten the planned effective life of the structure. The drainage area shall be large enough so that surface runoff and ground water flow will maintain an adequate supply of water in the pond. The quality shall be suitable for the water's intended use.

Ratios of drainage area to normal pond area greater than 1000 to 1 will normally have excessive sedimentation, unless the drainage area is flat or has good cover.

If the surface water is the only source of water the ratio of drainage area to normal pond area shall be at least 10 to 1.

Ponds shall be protected from the contamination from the barnyards, septic tanks, storm and sanitary sewers or other sources.

Reservoir Area. The topography and soils of the site shall permit storage of water at a depth and volume that ensure a dependable supply, considering beneficial use, sedimentation, season of use, and evaporation and seepage losses. If surface runoff is the primary source of water for a pond, the soils shall be impervious enough to prevent excessive seepage losses or shall be a type that sealing is practicable.

Design Criteria For Embankment Ponds

Foundation cutoff. A cutoff of relatively impervious material shall be provided under the dam if necessary. The cutoff shall be located at or upstream from the centerline of the dam. It shall extend up to abutments to the emergency spillway crest elevation and be deep enough to extend into a relatively impervious layer or provide for a stable dam when combined with seepage control. The cutoff trench shall have a minimum bottom width of 4 feet and adequate to accommodate the equipment used for excavation, backfill, and compaction operations. Side slopes shall not be steeper than one horizontal to one vertical. Compaction requirements shall be the same as those for embankments. The trench shall be kept free from standing water during the back-filling operation.

The minimum depth shall be at least 3 feet.

Seepage Control. Seepage control is to be included if (1) pervious layers are not intercepted by the cutoff, (2) seepage creates swamping downstream, (3) such control is needed to insure a stable embankment, or (4) special problems require drainage for a stable dam. Seepage may be controlled by (1) foundation, abutment, or embankment drains; (2) reservoir blanketing; or (3) a combination of these measures.

Earth Embankment. The area on which an embankment is to be placed shall consist of material that has sufficient bearing strength to support the embankment without excessive consolidation. The minimum top width for a dam is shown in table A10-1. If the embankment top is to be used as a public road, the minimum width shall be 16 feet for one-way traffic and 26 feet for two-way traffic. Guardrails or other safety measures shall meet the requirements of the responsible road authority.

Table A10-1 Minimum Top Width for Dams

Total Height of Embankment (feet)	Top Width (feet)
10 or less	6
10-15	8
15-20	10
20-25	12
25-35	14
35 or more	15

The combined upstream and downstream side slopes of the settled embankments shall not be less than five horizontal to one vertical, and neither slope shall be steeper than two horizontal to one vertical. All slopes must be designed to be stable, even if flatter sides slopes are required.

If needed to protect the slopes of the dam, special measures, such as berms, rock riprap, sand-gravel, soil cement, or

special vegetation, shall be provided (USDA Soil Conservation Service, Technical Release Nos. 56 and 69).

The minimum elevation of the top of the settled embankment shall be 1 foot above the water surface in the reservoir with the emergency spillway flowing at the design depth. The minimum difference in elevation between the crest of the emergency spillway and the settled top width of the dam shall be 2 feet for all dams having more than a 20 acre drainage area or more than 20 feet in effective height.

The design height of the dam shall be increased by the amount needed to insure that after settlement the height of the dams equals or exceeds the design height. This increase shall not be less than 10% when compaction is by hauling equipment or 5% if compactors are used, except where detailed soil testing and laboratory analysis shows that a lesser amount is adequate.

Compaction - The compaction requirements shall be specified.

Embankments of Other than Earthfill

Sediment basins with effective heights of less than 5 feet may use materials other than earth for the embankment. These embankments shall be structurally sound, and have hydraulic characteristics that will safely handle the principal and emergency spillway design storm.

Principal Spillway. A pipe conduit, with needed appurtenances, shall be placed under or through the dam, except where rock, concrete, or other types of mechanical spillways are used, or where the rate and duration of flow can be safely handled by a vegetated or earth spillway.

The crest elevation shall be no less than 0.5 feet below the crest of the emergency spillway for dams having a drainage area of 20 acres or less, and no less than 1 foot for those having a drainage area of more than 20 acres.

When the design discharge of the principal spillway is considered in calculating peak outflow through the emergency spillway, the crest elevation of the inlet shall be such that the full flow will be generated in the conduit before there is discharge through the emergency spillway. The inlets and outlets shall be designed to function satisfactorily for the full range of flow and hydraulic head anticipated.

The capacity of the pipe conduit shall be adequate to discharge long-duration, continuous, or frequent flows without flow through the emergency spillways. The pipe diameter shall be no less than 4 inches. If the pipe conduit diameter is larger than 10 inches, its design discharge may be considered when calculating the peak outflow rate through the emergency spillway.

For sediment basins, the minimum principal spillway pipe size shall be 8 inches for corrugated or helical pipe and 6 inches for smooth wall pipe.

Pipe conduits under or through the dam shall meet the following requirements: The pipe shall be capable of withstanding external loading without yielding, buckling, or cracking. Flexible pipe strength shall not be less than that necessary to support the design load with the maximum of 5 percent deflection. The inlets and outlets shall be structurally sound and made of materials compatible with those of the pipe. All pipe joints shall be made watertight by the use of couplings, gaskets, caulking, or by welding.

For dams 20 feet or less in effective height, acceptable pipe materials are cast-iron, steel, corrugated steel or aluminum, concrete, plastic, vitrified clay with rubber gaskets, and cast-in-place reinforced concrete. Concrete and vitrified clay pipe shall be laid in a concrete bedding. Plastic pipe that will be exposed to direct sunlight shall be made of ultraviolet-resistant materials and protected by coating or shielding, or provisions for replacement should be made as necessary. Connections of plastic pipe to less flexible pipe or structure must be designed to avoid stress concentrations that could rupture the plastic.

For dams more than 20 feet in effective height, conduits shall be plastic, reinforced concrete, corrugated steel or aluminum, or welded steel pipe. The maximum height of fill over any principal spillway steel or aluminum pipe must not exceed 25 feet. Pipe shall be watertight. The joints between sections of pipe shall be designed to remain watertight after joint elongation caused by foundation consolidation. Concrete pipe shall have concrete bedding or a concrete cradle if required. Cantilever outlet sections, if used, shall be designed to withstand the cantilever load. Pipe supports shall be provided when needed. Other suitable devices such as a Saint Anthony Falls stilling basin or an impact basin may be used to provide a safe outlet. Protective coatings of asphalt coated, or vinyl coating on galvanized corrugated metal pipe, or coal tar enamel on welded steel pipe should be provided in areas that have a history of pipe corrosion, or where the saturated soil resistivity is less than 4,000 ohmscm, or where soil pH is lower than 5.

Specifications in tables A10-2 and A10-3 are to be followed for polyvinyl chloride (PVC), steel, and aluminum pipe.

Cathodic protection is to be provided for coated welded steel and galvanized corrugated metal pipe where soil and resistivity studies indicate that pipe needs a protective coating, and where the need and importance of the structure warrant additional protection and longevity. If cathodic protection is not provided for in the original design and installation, electrical continuity in the form of joint-bridging straps should be considered on pipes that have protective coatings. Cathodic protection should be added later if mounting indicates the need.

Seepage control along a pipe conduit spillway shall be provided if any of the following conditions exists:

1. The effective height of the dam is greater than 15 feet.
2. The conduit is of smooth pipe larger than 8 inches in diameter.
3. The conduit is of corrugated pipe larger than 12 inches in diameter.

Table A10-2 :Acceptable PVC Pipe For Use in Earth Dams¹

Normal Pipe Size (inches)	Schedule for Standard dimension ratio (SDR)	Maximum depth of fill over pipe (feet)
4 or smaller	Schedule 40	15
	Schedule 80	20
	SDR 26	10
6, 8, 10, 12	Schedule 40	10
	Schedule 80	15
	SDR 26	10

1. Polyvinyl chloride pipe, PVC 1120 or PVC 1220, conforming to ASTM-1785 or ASTM-D-2241.

Table A10-3: Minimum Gauge for Corrugated Metal Pipe
(2-2/3-in x 1/2-in Corrugations)¹

Fill height (ft)	Minimum gauge for steel pipe with diameter (in) of-21 and						Minimum thickness (in) of aluminum pipe /2 with diameter (in) of- 21 and			
	less	24	30	36	42	48	less	24	30	36
1-15	16	16	16	14	12	10	0.06	0.06	0.075	0.075
15-20	16	16	16	14	12	10	.06	.075	.105	.105
20-25	16	16	14	12	10	10	.06	.105	.135	/3

1. Pipe with 6-, 8-, and 10-diameter has 1-1/2-in x 1/4-in corrugations.
2. Riveted or helical fabrication.
3. Not permitted

Seepage along pipes extending through the embankment shall be controlled by the use of a filter and drainage diaphragm, unless it is determined that antiseep collars will adequately serve the purpose.

The drain shall be minimum of 2 feet thick and extend vertically upward and horizontally at least three times the pipe diameter, and vertically downward at least 18 inches beneath the conduit invert. The drain diaphragm shall be located immediately downstream of the cutoff trench, approximately parallel to the centerline of the dam.

The drain shall be outletted at the embankment downstream toe, preferably using a drain backfill envelope continuously along the pipe to where it exists in the embankment. Protecting drain fill from the surface erosion will be necessary.

When antiseep collars are used in lieu of a drainage diaphragm, they shall have a watertight connection to the pipe. Maximum spacing shall be approximately 14 times the minimum projection of the collar measured perpendicular to the pipe. Collar material shall be compatible with the pipe materials. The antiseep collar (s) shall increase by 15% the seepage path along the pipe.

Closed conduit spillways designed for pressure flow must have adequate antivortex devices.

To prevent clogging of the conduit, an appropriate trash guard shall be installed at the inlet or riser.

A pipe with a suitable valve shall be provided to drain the pool area if needed for proper pond management or if required by state law. The principal spillway conduit may be used as a pond drain if it is located where it can perform this function.

Supply pipes through the dam to watering troughs and other appurtenances shall have an inside diameter of not less than 1-1/4 inches.

The minimum diameter principal spillway pipe for a dam which raises the water height by more than 5 feet measured from the downstream toe of the dam to the emergency spillway crest is 18 inches. A principal spillway shall be used except where:

1. The drainage area is 10 acres or less, there is no spring or seep flow and the emergency spillway exit channel is on stable grade all the way back to the existing channel.

- The drainage area is 10 acres or less, there is spring or seep flow and the emergency spillway exit channel is on a stable grade all the way back to the existing channel. For this condition a trickle tube shall be used in accordance with pages 11-13 and 11-16 of USDA, Soil Conservation Service, Engineering Field Manual.

Design Storm. Storage and effective height are defined under Scope.

- Table A10.4 defines minimum design storm for the principal spillway.
- Table A10.5 defines minimum design storm for the emergency spillway.

Table A10-4 Principal Spillway Minimum Design Storms ⁴

Type ¹	Raised ² Water Height (ft)	Product of the storage times the effective height of the Dam ³	Drainage Area (acres)	Principal Design Storm Design
All	≤5	≤300	< 320	1 yr 24 hr
Agriculture	>5	≤ 300	< 320	1 yr 24 hr
Non- Agriculture	>5	≤300	< 320	25yr 24 hr
All	≥5	301 - 3000	< 320	2 yr 24 hr
Agriculture	>5	301 - 3000	< 320	2 yr 24 hr
Non- Agriculture	>5	301 - 3000	< 320	25yr 24 hr
All	<5	< 300	> 320	1 yr 24 hr
All	>5	> 300	≥ 320	25yr 24 hr
All	≤5	301 - 3000	≥ 320	2 yr 24 hr
All	>5	301 - 3000	≥ 320	25yr 24 hr

- Agriculture is defined as being used in connection with the production of crops or livestock.
- Measured from the usual, mean low water height to the water surface during the emergency spillway design storm.
- As defined under "Scope".
- Spillway Storm is Type III.

Table A10-5 Emergency Spillway Minimum Design Storms⁵

Type ¹	Raised ² Water Height (feet)	Total Storage ³	Drainage Area (Acres)	Emergency Spillway Design Storm ⁴
All	< 5	< 50	≤ 20	10 yr 24 hr
Agriculture	5.1-20	< 50	≤ 20	10 yr 24 hr
Non- Agriculture	5.1-20	< 50	≤ 20	100 yr 24 hr
Agriculture	> 20	< 50	≤ 20	25 yr 24 hr
Non- Agriculture	> 20	< 50	≤ 20	100 yr 24 hr
All	≤ 5	≥ 50	≤ 20	50 yr 24 hr
Agriculture	5.1-20	≥ 50	≤ 20	50 yr 24 hr
Non- Agriculture	5.1-20	≥ 50	≤ 20	100 yr 24 hr
Agriculture	> 20	≥ 50	≤ 20	50 yr 24 hr
Non- Agriculture	> 20	≥ 50	≥ 20	100 yr 24 hr
All	≤ 5	< 50	21-320	25 yr 24 hr
Agriculture	5.1-20	< 50	21-320	25 yr 24 hr
Non- Agriculture	5.1-20	< 50	21-320	100 yr 24 hr
Agriculture	> 20	< 50	21-320	50 yr 24 hr
Non- Agriculture	< 20	< 50	21-320	100 yr 24 hr
All	≤ 5	≥ 50	21-320	50 yr 24 hr
Agriculture	5.1-20	≥ 50	21-320	50 yr 24 hr
Non- Agriculture	5.1-20	≥ 50	21-320	100 yr 24 hr
Agriculture	> 20	≥ 50	21-320	50 yr 24 hr
Non- Agriculture	> 20	≥ 50	21-320	100 yr 24 hr
All	≤ 5	all	> 320	50 yr 24 hr
All	> 5	all	> 320	100 yr 24 hr

1. Agriculture use is defined as being used in connection with the production of crops or livestock.
2. Measured from the usual, mean low water height to the water surface during the emergency spillway design storm.
3. Measured below the crest of the emergency spillway.
4. Any pond for which a state stream encroachment permit is required must use a minimum design storm of 100 yr 24 hr type III for the emergency spillway.
5. Design storm is the type III.

Pipe Conduit

1. Corrugated Steel Pipe - The pipe may be helical or riveted fabrication. Riveted pipe shall be closed riveted. Riveted pipe 36 inches or larger shall be doubled riveted. Pipe strength is not to be less than that indicated in table A10-7.

If corrugated metal pipes are used on embankments which raise the water height by more than 5 feet, the fill height over the pipe may not exceed 15 feet, and cathodic protection must be provided.

2. Corrugated Aluminum Pipe - The maximum effective fill height, as defined under Scope, shall be 20 feet or less. The pipe may be helical or riveted fabrication. Riveted pipe shall be closed riveted. Riveted pipe 36 inches or larger shall be double riveted. Pipe strength is not to be less than that indicated in table A10-8.

Fittings for aluminum pipe materials other than aluminum or aluminized steel must be separated from the aluminum pipe at all points by at least 24 mils, or by other permanent insulating material that effectively prevents galvanic corrosion.

Bolts used to join aluminum and steel must be galvanized, plastic coated, or otherwise protected to prevent galvanic corrosion.

Bolts used to join aluminum, other than aluminum alloy bolts, must be galvanized, plastic coated, or otherwise protected to prevent galvanic action.

3. Plastic Pipe - PVC becomes brittle after years of exposure to sun and is susceptible to damage from impact, especially during periods of low temperature. Provisions should be made for protection from impact where necessary. Thicker walled pipe has greater resistance to damage from the ultraviolet rays of the sun. PVC pipe exposed to the sun should be protected by paint or by shielding to screen the ultraviolet rays. Use a good grade of water based paint. Paints with other based material might have an adverse effect on the plastic pipe. Repainting should be required as needed to retain the integrity of this ultraviolet protection.

Numerous other plastic materials are available but deterioration from sunlight, damage from impact, or susceptibility to fire make these less desirable for applications involving these exposures.

4. Smooth Steel - The maximum fill over the pipe shall not exceed 25 feet. The minimum wall thickness shall be 3/16 inch. The maximum size principal spillway barrel shall be 48 inches. Pipe joints shall be threaded or welded.
5. Vitrified Clay Pipe - The maximum effective fill height as defined under Scope, shall be 20 feet or less. The maximum principal spillway barrel size shall be 36 inches.
6. Concrete and Cast in Place Reinforced Concrete - The principal spillway shall meet the requirements of USDA, SCS Technical Release 60, Earth Dams and Reservoirs.

Pipe Conduits for Sediment basins shall have pipe conduits with required appurtenances except where a structural spillway is used.

1. The materials and installation for pipe conduits for excavated sediment basins shall meet the local municipality requirements for culverts or storm sewers.
2. Conduits for embankment sediment basins shall meet the following requirements:
 - a. The pipe shall be capable of withstanding the external loading without yielding, buckling or cracking.

- b. All joints shall be watertight.

Inlet for Pipe Conduit

The inlet shall be structurally sound and made from materials compatible with the pipe. The inlet shall be designed to prevent flotation.

1. Hood Inlet - If the pipe is designed for pressure flow, the stage in the pond below the emergency spillway elevation shall be adequate to prime the pipe. For smooth wall pipe this is 1.4D. For corrugated pipe this is 1.8D. D is the inside diameter of the pipe.
2. Drop Inlet - If the pipe is designed for pressure flow:
 - a. The weir length shall be adequate to prime the emergency spillway elevation. See USDA, Soil Conservation Service, Engineering Field Manual for conservation practices page 6-43.
 - b. For pipe on less critical slope, the drop inlet shall be at least 2D deep, where D is the conduit diameter.
 - c. For pipe on critical slope or steeper, the drop inlet shall be at least 5 D deep, where D is the conduit diameter.
3. Outlet for Pipe Conduit - Conduits larger than 18 inch shall have one of the following types of outlets:
 1. SAF stilling basin
 2. Impact Basin
 3. Cantilever outlet with the stilling basin. The invert of the cantilever outlet shall be above the water surface of the downstream channel when the principal spillway is flowing at the design capacity.

The cantilever outlet will be supported on a bent or pier and will extend a minimum of 8 feet beyond the bent or pier. The bent or pier will extend below the lowest elevation anticipated in the scour hole or to unweathered, sound rock. Guidance on the design of stilling basins is a USDA's SCS Design Note No. 6. Armored Scour Hole for Cantilever Outlet.

4. Conduit Outlet Protection - In accordance with the "Standards for Conduit Outlet Protection", pg. 12-1.

Antiseep Collars

When antiseep collars are used in lieu of a drainage diaphragm, the following criteria are to be used to determine the size and number of antiseep collars.

Let V = vertical projection and minimum horizontal projection of the antiseep collar feet

Let L = length in feet of the conduit within the zone of saturation, measured from the downstream side of the riser to the tow drain or point where phreatic line intercepts the conduit, whichever is shorter.

Let n = number of antiseep collars.

The ratio of the length of the seepage (L + 2 n V) to L is to be at least 1.15. Antiseep collars should be equally spaced along the part of the barrel within the saturated zone at distances of not more than 25 feet.

The anti-seep collars and their connections to the pipe shall be watertight. The collar material shall be compatible with pipe materials.

Emergency Spillways.

Emergency spillways convey large flood flows safely past earth embankments.

An emergency spillway must be provided for each dam, unless the principal spillway is large enough to pass the peak discharge from the routed hydrograph and the trash that comes to it without overtopping the dam. The following are minimum criteria for acceptable use of closed conduit principal spillway without an emergency spillway:

A conduit with a cross-sectional area of 3 square feet or more, an inlet that will not clog, and an elbow designed to facilitate the passage of trash.

The minimum capacity of a natural or constructed emergency spillway shall be that required to pass the peak flow expected from a design storm of the frequency and duration shown in table A10-6, less than reduction creditable to conduit discharge and detention storage.

Table A10-6: Minimum Spillway Capacity

Drainage area (acre)	Effective height of dam ¹ (feet)	Storage (acre-ft)	Minimum design storm ²	
			Frequency (year)	Minimum duration (hour)
20 or less	20 or less	Less than 50	10	24
20 or less	More than 20	Less than 50	25	24
More than 20	20 or less	Less than 50	25	24
All others			50	24

1. As defined under "Scope".
2. Select rain distribution based on climatological region

The emergency spillway shall safely pass the peak flow, or the storm runoff shall be routed through the reservoir. The routing shall either start with water surface at the elevation of the crest of the principal spillway or at the water surface after 10 days drawdown, whichever is higher. The 10 day drawdown shall be computed from the crest of the emergency spillway or from the elevation that would be attained if the entire design storm were impounded, whichever is lower. Emergency spillway shall provide for passing the design flow at safe velocity to a point downstream where the dam will not be endangered.

Constructed emergency spillways are open channels that usually consist of an inlet channel, a control section, and an exit channel. They shall be trapezoidal and shall be located in undisturbed or compacted earth. The side slopes shall be stable for the material in which the spillway is to be constructed. For dams having an effective height exceeding 20 feet, the emergency spillway shall have a bottom width of not less than 10 feet.

Upstream from the control section, the inlet channel shall be level for the distance needed to protect and maintain the crest elevation of the spillway. The inlet channel may be curved to fit existing topography. The grade of the exit channel of a constructed emergency spillway shall fall within the range established by discharge requirements and permissible velocities.

When design discharge of the principal spillway is considered in calculating peak outflow through the emergency spillway, the crest elevation through the inlet shall be such that full flow will be generated in the conduit before there is discharge through the emergency spillway.

Emergency spillways shall provide for passage of the design flow at a safe velocity to a point downstream where the dam will not be endangered. The maximum permissible velocity in the exit channel shall be 4 feet per second where only sparse vegetative cover can be expected and maintained, and 6 feet per second where excellent vegetative cover, a vigorous sod, can be expected and maintained.

Cross-section side slopes shall be 2 to 1 or flatter. Component parts of the emergency spillway are as follows;

1. Inlet Channel - The inlet channel shall be level for at least 20 feet upstream of the control section.
2. Exit Channel - The design flow should be contained in the exit channel without the use of dikes. If a dike is necessary it shall have at least 2:1 side slopes, 8 feet top width and be high enough to contain the design flow. The exit channel shall be straight for at least 50 feet downstream of the control section.

The exit channel shall carry the design flow downstream to a point where the flow will not discharge on the toe of the embankment.

Structural Emergency Spillways.

If chutes or drops are used for the principal spillways or principal emergency or emergency spillways, they shall be designed according to the principles set forth in USDA, Soils Conservation Service Engineering Field Manual for Conservation Practices and the National Engineering Handbook - Section 5, Hydraulics; Section 11, Drop Spillways; and Section 14, Chute Spillways. The minimum capacity of a structural spillway shall be that required to pass the peak flow expected from a design storm of the frequency and duration shown in table A10.6, less any reduction creditable to conduit discharge and detention storage.

Visual Resource Design.

The visual resource design of ponds shall be carefully considered in areas of high public visibility and those associated with recreation. The underlying criterion for all visual design is appropriateness. The shape and form of ponds, excavated material, and plantings are to relate visually to their surroundings and to their function.

The embankment may be shaped to blend with the natural topography. The edge of the pond may be shaped so that is generally curvilinear rather than rectangular. Excavated material can be shaped so that the final form is smooth, flowing, and fitting to the adjacent landscape rather than angular geometric mounds. If feasible, islands may be added for visual interest and to attract wildlife.

Components for Visual Design Ponds are as follows:

Drains - All ponds which raise the water height more than five feet must be provided with a device to permit draining of the reservoir. All pipe conduits used as drains must meet the same requirements as the pipe conduit for the principal spillway.

Vegetation - The dam, emergency spillway, spoil and borrow areas, and other disturbed areas above normal water level shall be planted in accordance with the standard for critical area (see also SSCC Standard for Temporary (3.1) and Permanent (3.2) Vegetative Cover. A grass strip or other suitable protection shall be provided around the pond to protect against sedimentation and erosion.

Construction Inspection - Embankments which raise the water height (measured at the emergency spillway crest) more than five feet must have constant inspection during construction by a licensed professional engineer. A monthly written

report of construction shall be prepared and submitted to the New Jersey Department of Environmental Protection Dam Safety Section.

Fencing - The embankment, spillway, and pond shall be fenced where necessary to protect the vegetation or for safety.

Dam Inspections - Dams which raise the water height by more than five feet shall have regular inspections performed every two years and a formal inspection performed every six years. An informal inspection shall be performed on the off year from the regular inspections. In the year of the formal inspection, regular and informal inspections need not be performed.

"Formal Inspection" means the inspection by a New Jersey licensed professional engineer to re-evaluate the safety and integrity of the dam and appurtenant structures to determine if the structure meets current design criteria, including a field inspection and a review of the records on project design, construction, and performance.

"Regular Inspection" means the visual inspection of a dam by a New Jersey licensed professional engineer to detect any signs of deterioration in material, developing weaknesses or unsafe hydraulic or structural behavior.

"Informal Inspection" means the visual inspection of the dam by the dam owner or operator to detect apparent signs of deterioration or other deficiencies of the dam structure or function.

Operation and Maintenance - An operation and maintenance manual will be developed for each pond which raises the water height by more than five feet.

The purpose of the manual is to provide guidance and instruction for the proper operation and maintenance of the pond and dam. The manual shall be composed of two parts. Part One must include the introduction, project description, project authorizations, project history, and list of project contracts. Part Two must contain the operation and maintenance instructions for major project facilities and equipment.

Ponds which raise the water height by five feet or less shall have an operation and maintenance schedule included in the design and made part of the farm plan. A yearly inspection shall include but not be limited to the following items plus any item unique to the particular pond:

- a. Plugged and deteriorating trash rack, riser, and water control gates.
- b. Damage to water pipe, valve, and watering facilities.
- c. Damage to pipe outlets and animal guards.
- d. Unstable wet areas below earthfills.
- e. Damaged or deteriorating fences.
- f. Wave damage to shoreline.
- g. Muskrat damage to the embankment or shoreline.
- h. Keep vegetation healthy and trim on the dam and earth spillway by liming, fertilizing, and mowing periodically. This also helps control undesirable brush and vegetative growth.
- i. Do not permit trees to grow on the dam.

Design Criteria for Excavated Ponds

Runoff.

Runoff flow pattern shall be considered when locating the pond and placing the spoil.

Provisions shall be made where needed for a principal spillway, emergency spillway, and embankment in accordance with the embankment criteria (see table A10-6).

Side Slopes.

Side slopes of the excavated ponds shall be stable and shall not be steeper than two horizontal to one vertical above the normal water level and 1 1/2 horizontal to one vertical below the normal water level. If livestock will water directly from the pond, a watering ramp of ample width shall be provided. The ramp shall extend to the anticipated low water elevation at a slope no steeper than 5 horizontal to one vertical. The watering ramp shall have a gravel or paved surface.

Perimeter Form.

If the structures are to be used for recreation or are highly visible to the public, the perimeter or edge should be curvilinear.

Inlet Protection.

If surface water enters the pond in a natural or excavated channel, the side slope of the pond shall be protected against erosion.

Excavated Material.

The material excavated from the pond shall be placed so that its weight will not endanger the stability of the pond side slopes and so that it will not be washed back into the pond by rainfall. It shall be disposed of in one of the following ways:

1. Uniformly spread to height that does not exceed 3 feet with the top grade to a continuous slope away from the pond.
2. Uniformly placed or shaped reasonably well with side slopes assuming a natural angle of repose. The excavated material will be placed at a distance equal to the depth of the pond but not less than 12 feet from the edge of the pond.
3. Shaped to a designed form that blends visually with the landscape.
4. Used for low embankment and leveling.
5. Hauled away.

The side slopes, spoiled material, and other disturbed areas above normal water level shall be planted in accordance with the critical area planting standard (see Also Standard for Temporary (pg. 7-1) and Permanent (pg. 5-1) Vegetative Cover).

Plans and Specifications. Plans and specifications for installing ponds shall be in keeping with this standard and shall describe the requirements for applying the practice to achieve its intended purpose.

Table A10-7 Minimum Gage for Corrugated Metal Pipe Risers
 2 2/3 - inch x 1/2 inch Corrugations
 Steel - Minimum Gage

Fill Height Above Pipe (feet)	Risers Only		
	54	60	66
1 - 15			
15 - 20	10	8	8
20 - 25	8	8	8

Table A10-8 Aluminum Minimum Gage (inches)

	Risers Only		
	42	48	54
	12(.105)	10(.135)	10(.135)
Risers Only	12(.105)	10(.135)	10(.135)
10(.135)	10(.135)	10(.135)	10(.135)

Construction Specifications For Embankment Ponds

Foundation Preparation

The foundation area shall be cleared of trees, logs, stumps, roots, brush, boulders, sod and rubbish. If needed to establish vegetation, the topsoil and sod shall be stockpiled and spread on the completed dam and spillways. Foundation surfaces shall be sloped no steeper than a ratio of one horizontal to one vertical. The foundation area shall be thoroughly scarified before placement of the fill material. The surface shall have moisture added, or it shall be compacted if necessary so that the first layer of fill material can be compacted and bonded to the foundation.

The cutoff trench and any other required excavation shall be dug to the lines and grades shown on the plans or as staked in the field. If they are suitable, excavated materials may be used in the permanent fill. Existing stream channels in the foundation area shall be sloped no steeper than a ratio of one horizontal to one vertical. They shall be deepened and widened as necessary to remove all stones, gravel, sand, stumps, roots, and other objectionable material and to accommodate compaction equipment.

Foundation areas shall be kept free of standing water when fill is placed on them.

Fill Placement

The material placed in the fill shall be free of detrimental amounts of sod, roots, frozen soil, stones more than 6 inches in diameter (except rock fills) and other objectionable material.

Drainfill shall be kept from being contaminated by adjacent soil materials during placement by either placing it in a cleanly excavated trench or by keeping the drain at least one foot above the adjacent earthfill.

Selected drainfill and backfill material shall be placed around structures, pipe conduits, and antiseep collars at about the same rate on all sides to prevent damage from unequal loading.

Fill material shall be placed and spread beginning at the lowest point in the foundation and then bringing it up in horizontal layers thick enough that the required compaction can be obtained. The fill shall be constructed in continuous horizontal layers. If openings or sectionalized fills are required, the slope of the bonding surfaces between the embankment in place and the embankment to be placed shall not be steeper than the ratio of three horizontal to one vertical. The bonding surface shall be treated the same as that specified for the foundation to insure a good bond with the new fill.

The distribution and gradation of materials shall be such that no lenses, pockets, streaks, or layers of material shall differ substantially in texture or gradation from the surrounding material. If it is necessary to use materials of varying texture and gradation, the more impervious material shall be placed in the center and upstream parts of the fill. If zoned fills of substantially differing materials are specified, the zones shall be placed according to lines and grades shown on the drawings. The complete work shall conform to the lines, grades, and elevations shown on the drawings or as staked in the field.

Moisture Control

The moisture content of the fill material shall be adequate for obtaining the required compaction. Material that is too wet shall be dried to meet this requirement, and material that is too dry shall be wetted and mixed until the requirement is met.

Compaction

Construction equipment shall be operated over each layer of fill to insure that the required compaction is obtained. Special equipment shall be used if needed to obtain the required compaction.

If a minimum required density is specified, each layer of fill shall be compacted as necessary to obtain that density.

Fill adjacent to structures, pipe conduits, and drainfill or antiseep collars shall be compacted to a density equivalent of that of the surrounding fill by hand tamping or by using manually directed power tampers or plate vibrators. Fill adjacent to concrete structures shall not be compacted until the concrete has had time to gain enough strength to support the load.

Protection

A protective cover of vegetation shall be established on all exposed surfaces of the embankment, spillway, and borrow area if soil and climatic conditions permit. If soil and climatic conditions preclude the use of vegetation and protection is needed, non-vegetated cover such as mulches or gravel may be used. In some places, temporary vegetation may be used until permanent vegetation can be established. The embankment and spillway shall be fenced if necessary to protect the vegetation.

Preparing the seedbed, seeding, fertilizing, and mulching shall comply with instructions in technical guidelines.

Principal Spillway

Corrugated metal pipe shall conform to the requirements of Federal Specifications WW-P-402 or WW-P-405, as appropriate. Other pipe materials shall conform to the appropriate specifications. Antiseep collars shall be made of materials compatible with that of the pipe and shall be installed so that they are watertight. The pipe shall be installed according to the manufacturer's instructions. It may be firmly and uniformly bedded throughout its length and shall be installed to the line and grade shown on the drawings.

Concrete

The mix design and testing of concrete shall be consistent with the size requirements of the job. Mix requirements or necessary strength shall be specified. The type of cement, air entrainment, slump, aggregate, or other properties shall be specified as necessary. All concrete is to consist of a workable mix that can be placed and finished in an acceptable manner. Necessary curing shall be specified. Reinforcing steel shall be placed as indicated on the plans and shall be held securely in place during concrete placement. Subgrades and forms shall be installed to line and grade, and the forms shall be mortar tight and unyielding as the concrete is placed.

Foundation and Embankment Drains

Foundation and embankment drains, if required, shall be placed to the line and grade shown on the drawings. Detailed requirements for drain material and any required pipe shall be shown in the drawing and specifications for the job.

Excavated Ponds

The compacted excavation shall conform to the lines, grades, and elevations shown on the drawings or as staked in the field.

Embankment and Excavated Ponds

Construction operations shall be carried out so that erosion and air and water pollution are minimized and held within legal limits. All work shall be conducted in a skillful manner. The completed job shall present a workman like appearance.

Measures and construction methods that enhance fish and wildlife values shall be incorporated as needed and practical. Fencing and cover to control erosion shall be established as needed. Appropriate safety measures, such as warning signs, rescue facilities, and fencing shall be provided as needed.

APPENDIX A11

REFERENCES

The following references are cited in the standards:

1. Engineering Field Manual, Washington, D.C., Soil Conservation Service, U. S. Department of Agriculture, 1979.
2. Tentative Design Procedures for Riprap - Lined Channels, National Cooperative Highway Research Program Report 108, Washington, D. C., Highway Research Board, National Research Council, 1970.
3. Predicting Rainfall - Erosion Losses, A Guide to Conservation Planning, Agricultural Handbook No. 537, Washington, D. C., Science and Education Administration, U. S. Department of Agriculture, December 1978.
4. Section 4, Hydrology, National Engineering Handbook, Washington, D.C., Soil Conservation Service, U. S. Department of Agriculture, 1971.
5. Maccaferri Gabions Technical Handbook, New York, N. Y., Maccaferri Gabions of America, Inc.
6. Chow, Ven T., Open Channel Hydraulics, New York, N. Y., McGraw-Hill, 1959.
7. Roughness Characteristics of Natural Channels, Water-Supply Paper 1849. Washington, D. C., U. S. Geological Survey, 1967.
8. Design of Open Channels, Technical Release No. 25, Washington, D. C., Soil Conservation Service, U. S. Department of Agriculture, October 1977.
9. Urban Hydrology for Watersheds, Technical Release No. 55, Washington, D. C., Soil Conservation Service, U. S. Department of Agriculture, 1986.
10. Standard Specifications for Road and Bridge Construction, Trenton, N.J., New Jersey Department of Transportation 1983 with revisions.
11. Standards for Soil Erosion and Sediment Control, N.J. Association of Conservation Districts, 1987.

OTHER REFERENCES

The following references provide additional information on subjects covered in the Standards:

Duell, Robert W., Highway Vegetation, Bulletin 822, New Brunswick, N. J., Rutgers College of Agriculture and Environmental Science.

Duell, R. W., and R. M. Schmit, Better Grasses for Roadsides, Transportation Research Record No. 551, National Academy of Science, 1975, pp. 30-41.

Fletcher, B. P. and Grace, J. S., Jr., Practical Guidance for Estimating and Controlling Erosion at Culvert Outlets, 1972, Corps of Engineers Research, Report H-72-5, Waterways Experiment Station, Vicksburg, Mississippi.

Funk, C. R., R. E. Engel, R. W. Duell, and W. K. Dickson, "Kentucky Bluegrass for New Jersey Turf", Rutgers Turf Grass Proceedings. New Brunswick, N. J., Soils and Crops Offset Series No. 9, 1978, pp. 120-142.

Guideline Specifications to Sodding. Hastings, Nebraska, American Sod Producers Association, Inc.

Lacey, Donald B., Ground Covers - Carpets for Outdoor Living, Extension Service Publication 351-A. New Brunswick, N. J., Rutgers College of Agriculture and Environmental Science, 1970.

Lane, E.W. 1955. Design of stable alluvial channels. Transactions, American Society of Civil Engineers 120: 1234-1279.

Nathan, Kurt, R. B. Alderfer, S. A. Decter, R. N. Hanna, M. E. Singley, K. S. Werkman, and K. T. Wilson, Water Control Guide for Suburban and Rural Residential New Jersey, Circular 605, New Brunswick, N. J., Rutgers College of Agriculture and Environmental Science, 1965.

O'Knefski, R. C., C. R. Funk, R. E. Engel and R. W. Duell, Lawn Grasses for New Jersey, Leaflet 509, New Brunswick, N. J., Rutgers College of Agriculture and Environmental Science, 1975.

O'Knefski, R. C., C. R. Funk, R. E. Engel and R. W. Duell, "Lawn Grasses for New Jersey," Rutgers Turf Grass Proceedings, New Brunswick, N. J., Soils and Crops Offset Series No. 6, 1975, pp. 89-94.

Poertner, H.G., Modified Rational Method, Special Report 43, American Public Works Association, Chicago, Illinois, 1974

Robinson, K.M., Rice, C.E., and Kadavy, K.C., Design of Rock Chutes, Transactions, American Society of Agricultural Engineers, Vol. 41(3):621-626. 1998

Schmit, R. N., C. R. Funk, and R. W. Duell, "Morphology and Behavior of the Fine Fescues," Rutgers Turf Grass Proceedings, New Brunswick, N. J., Soils and Crops Offset Series No. 5, 1974, pp. 4-8.

Simons, Daryl B., Chen, Ung H., Swenson, Lawrence J., Hydraulic Test to Develop Criteria for the Use of Reno Matters, Civil Engineering Department, Engineering and Research Center, Colorado State University, Fort Collins, Colorado, March 1984.

Tedrow, J. C. F., New Jersey Soils, Circular 601, New Brunswick, N. J., Rutgers College of Agriculture and Environmental Science.

The following references are cited in the Appendices:

- a1. Fortier, S. F. and Scobey, F. C., Permissible Canal Velocities, American Society of Civil Engineering Transactions, Vol. 89, pp. 940-956.
- a2. Lane, E. W., Progress Report on Results of Studies on Design of Stable Channels, Hydraulic Laboratory Report No. Hyd-352, U. S. Bureau of Reclamation, June 1952.
- a3. Standards for Permissible Non-Eroding Velocities, Bureau of the Methodology of the Hydro-Energy Plan; Gidrotekhnicheskoye Stroitel'stvo, Obedinennoye Nauchno-Tekhnicheskoye 12 dated 'stvo., Moscow, USSR, May 1936.
- a4. Einstein, H. A., The Bedload Function for Sediment Transportation in Open Channel Flow, USDA Technical Bulletin No. 1026, September 1950.
- a5. Vanoni, V. A. and Brooks, N. H., Laboratory Studies of the Roughness and Suspended Load of Alluvial Streams, U. S. Army Corps of Engineers, Missouri River Division Sediment Series No. 11, December 1957.
- a6. Standards for Soil Erosion and Sediment Control, N.J., Association of Soil Conservation Districts, 1987.

LAND USE LAND COVER CLASSIFICATION SYSTEM

(Derived from: A Land Use and Land Cover Classification System for Use with Remote Sensor Data, U. S. Geological Survey Professional Paper 964, 1976; edited by NJDEP, OIRM, BGIA, 1998, 2000, 20001. Note: Classes used in NJDEP mapping programs shown in **bold**.)

1000	URBAN OR BUILT-UP LAND	1212	Other Institutional
1100	RESIDENTIAL	1213	Mixed Commercial & Services
1110	Residential (High Density or Multiple dwelling)	1214	Former Military; Indeterminate Use
1111	Single Unit, High Density	<hr/>	
1112	Multiple Dwelling, Low Rise (3 stories or less)	1300	INDUSTRIAL
1113	Multiple Dwelling, High Rise (4 stories or more)	1310	Light Industrial
1120	Residential (Single Unit, Medium Density)	1320	Heavy Industrial
1130	Residential (Single Unit Low Density)	1330	Power Generation
1140	Residential (Rural, Single Unit)	<hr/>	
1150	Mixed Residential	1400	TRANSPORTATION, COMMUNICATION & UTILITIES
<hr/>		1410	Limited Access Highways
1200	COMMERCIAL & SERVICES	1420	Railroad Facilities
1201	Central Business District (CBD)	1430	Bus and Truck Terminals
1202	Commercial Strip Development	1440	Airports
1203	Isolated Commercial Establishments for Goods and/or Services	1450	Port Facilities
1204	Isolated Commercial Office Buildings	1460	Power Facilities
1205	Shopping Centers	1461	Wetland Rights-of-Way
1206	Resorts, Hotels, Motels & Related facilities	1470	Water Treatment Facilities
1207	Educational Institutions	1480	Sewage Treatment Facilities
1208	Health Institutions	1490	Other Transportation, Communication and Utilities
1209	Correctional Institutions	<hr/>	
1210	Government Centers	1500	INDUSTRIAL & COMMERCIAL COMPLEXES
1211	Military Installations	1510	Industrial and Commercial Parks
		<hr/>	
		1600	MIXED URBAN OR BUILT-UP
		1610	Predominantly Residential - (>50%, but <66% of the use can be identified as Residential).

1620	Predominantly Commercial/Service - (>50%, but <66% of the use can be identified as Commercial/Service).	2000 AGRICULTURAL LAND
1630	Predominantly Industrial - (>50%, but <66% of the use can be identified as Industrial).	2100 CROPLAND AND PASTURELAND
1640	Predominantly Transportation/Communication/Utilities - (>50%, but <66% of the use can be identified as Transportation/Communication/Utilities).	2110 Harvested Cropland
1650	Heterogeneous Mixture - (No single use in the intermixture comprises more than 50%).	2120 Pastureland
		2130 Inactive Cropland
		2140 Agricultural Wetlands
		2150 Former Agricultural Wetlands- Becoming Shrubby, not Built-up
1700	OTHER URBAN OR BUILT-UP	2200 ORCHARDS, VINEYARDS, NURSERIES AND HORTICULTURAL AREAS
1710	Cemeteries	2210 Orchards
1720	Undeveloped Land Within Urban Areas	2220 Vineyards
1730	Inactive Land With Street Patterns	2230 Nurseries
1740	Open Areas	2240 Floriculture
1750	Managed Wetland in Maintained Lawn Greenspace	2250 Sod and Seed Farms
1800	RECREATIONAL LAND	2260 Cranberry Farms
1801	Golf Courses	2270 Inactive
1802	Picnic and Camping Parks	2280 Blueberry Farms
1803	Marina and Boat Launches	2300 CONFINED FEEDING OPERATIONS
1804	Community Recreation Areas	2310 Cattle and Swine Feedlots
1805	Parks	2320 Poultry Farms
1806	Swimming Pools	2330 Specialty Farms
1807	Swimming Beaches	2400 OTHER AGRICULTURE
1808	Formal Lawns, Arboretums and Landscaped Areas	2410 Experimental Agriculture Fields
1809	Open Areas in Parks	2420 Isolated Structures for Crop or Equipment Storage
1810	Stadium, Theaters, Cultural Centers, and Zoos	2430 Horse Farm
1811	Other Recreational	2440 Agricultural Dikes/Roadways
1850	Managed Wetland in Built-up Maintained Rec Area	3000 RANGELAND

4000	FORESTLAND	5100	STREAMS & CANALS
4100	DECIDUOUS	5110	Streams
4110	Deciduous, 10-50% Crown Closure	5120	Canals
4120	Deciduous > 50% Crown Closure	5200	NATURAL LAKES
4200	CONIFEROUS	5210	Small Lakes
4210	Coniferous, 10-50% Crown Closure	5220	Medium Lakes
4220	Coniferous, > 50% Crown Closure	5230	Large Lakes
4230	Plantation	5300	ARTIFICIAL LAKES & RESERVOIRS
4300	MIXED DECIDUOUS/CONIFEROUS	5310	Artificial Lakes
4310	Mixed with Coniferous Prevalent (> 50% Coniferous)	5320	Multiple Use Reservoirs
4311	Mixed with Coniferous Prevalent (10%-50% Crown Closure)	5330	Restrictive Use Reservoirs
4312	Mixed with Coniferous Prevalent (> 50% Crown Closure)	5400	BAYS, ESTUARIES & OTHER TIDAL WATERS
4320	Mixed with Deciduous Prevalent (> 50% Deciduous)	5410	Tidal Rivers, Inland Bays and Other Tidal waters
4321	Mixed with Deciduous Prevalent (10%-50% Crown Closure)	5411	Open Tidal Bays
4322	Mixed with Deciduous Prevalent (> 50% Crown Closure)	5420	Dredged Lagoon, Artificial
4400	BRUSHLAND/SHRUBLAND (Height<20 feet)	5430	Atlantic Ocean
4410	Old Field (<25% Brush Covered)	6000	WETLANDS
4420	Deciduous Brush/Shrubland (>25% Brush Covered with Deciduous Species Predominant > 75%)	6100	COASTAL WETLANDS
4430	Coniferous Brush/Shrubland (>25% Brush Covered with Coniferous Species Predominant > 75%).	6110	Saline Marshes
4440	Mixed Deciduous/Coniferous Brush/Shrubland (>25% Brush Covered with a Mixture of Deciduous Coniferous Species; <75% of One Type)	6120	Freshwater Tidal Marshes
4500	SEVERE BURNED UPLAND VEGETATION	6130	Vegetated Dune Communities
5000	WATER	6200	INTERIOR WETLANDS
		6210	Deciduous Wooded Wetlands
		6220	Coniferous Wooded Wetlands
		6221	Atlantic White Cedar Wetlands
		6230	Brush-Dominate and Bog Wetlands
		6231	Deciduous Brush and Bog Wetlands

6232	Coniferous Brush and Bog Wetlands	7310	Stone Quarries
6233	Mixed Brush and Bog Wetlands with Deciduous Dominant	7320	Sand and Gravel Pits (Borrow Pits)
6234	Mixed Brush and Bog Wetlands with Coniferous Dominant	7330	Other Mining
		7340	Abandoned Mining Sites
6240	Non-Tidal Marshes	7400	ALTERED LANDS
6250	Mixed Wooded Wetlands	7410	Solid Waste Disposal Areas
6251	Mixed Wooded Wetland with Deciduous Prevalent	7420	Dredge Material Disposal Sites
6252	Mixed Wooded Wetlands with Coniferous Prevalent	7430	Disturbed Wetlands
6500	SEVERE BURNED WETLANDS	7500	TRANSITIONAL AREAS
7000	BARREN LAND	7510	Single Unit Residential Under Construction
7100	BEACHES	7520	Multiple Unit Residential Under Construction
7110	Open Beach	7530	Commercial/Service Under Construction
7120	Unvegetated Dune Communities	7540	Industrial Under Construction
7130	Other Sandy Areas	7550	Transportation/Communication/Utilities Under Construction
7200	BARE EXPOSED ROCK, ROCK SLIDES, ETC.	7560	Industrial/Commercial Parks Under Construction
7210	Rock Faces, Rock Slides, Cliffs	7570	Unknown Use Under Construction
7220	Exposed Rock	7580	Abandoned Structures (Non-Urban)
7300	EXTRACTIVE MINING	7600	UNDIFFERENTIATED BARREN LAND
		8000	MANAGED WETLANDS

1/22/01 2:21 PM

APPENDIX B

EXAMPLES OF SEED SPECIFICATIONS

- A. The seed mixtures and specifications shall meet the following minimum requirements.
1. Furnish the kinds and amounts of seed as indicated below to be seeded in all areas designated by the engineer, landscape architect in the certified soil erosion and sediment control plan.

(List mixtures and amounts of each species here)
 2. The minimum requirements for grass and legume seed used for temporary and permanent vegetative stabilization work are as follows:
 - a. All seed shall be labeled to show that it meets the requirements of the New Jersey State Seed Law N.J.S.A. 4:17-13 et. seq. and rules promulgated thereto.
 - b. Accumulated bag tags of seed used shall be submitted with the final pay estimate and may be requested by the Soil Conservation District for a report of compliance.
 - c. All seed shall have been tested within the 9 months immediately preceding the date of seeding such material on this job.
 - d. Inoculant - The innoculant for treating legume seed in the seed mixtures shall be a pure culture of nitrogen-fixing bacteria prepared for the species seeded. Inoculant shall not be used later than the date indicated on the container. Twice the supplier's recommended rate of inoculant will be used when seed is broadcasted; four times the recommended rate if hydroseeded.
 - e. The amount of all warm season grass to be planted for temporary and permanent stabilization shall be adjusted to reflect the amount of pure live seed (PLS) by reducing the weight of inert matter, non viable and undesirable seed as expressed on the seed tag. The adjustment is made by multiplying the weight of the seed bag x % seed purity x % germination = amount of PLS. No adjustment is required for cool season grasses.

Example: A 50 lb bag of seed with 95% purity and 60% germination = 28.5 lbs. of PLS.
 - f. (The Quality of Seed table on the following page may be used to specify the minimum seed purity and germination of seed to be used on the project.)
- B. Grass seed mixtures can be tested by the State Seed Analyst, New Jersey Department of Agriculture, Trenton, New Jersey, to verify to the purchaser that the mixture or % germination conforms with the label pursuant to the rules of the State Seed Law, NJAC 2:21-1 et. seq.

TABLE B -1
QUALITY OF SEED*

<u>Cultivars</u>	<u>Minimum** Seed Purity (%)</u>	<u>Minimum Germination (%)</u>
<u>PERENNIAL LEGUME</u>		
Clover, White	98	90
Crownvetch	95	75
Lespedeza, Sericea	98	85
<u>PERENNIAL GRASSES</u>		
Bentgrass, Creeping	98	85
Bermudagrass	98	85
Bluegrass, Kentucky	98	85
Fescue, Hard	98	85
Fescue, red (chewing and (creeping)	98	85
Fescue Sheep	90	95
Fescue, tall (KY-31)	98	85
Redtop	92	85
Reed Canarygrass	96	80
Ryegrass, Perennial	98	90
Weeping lovegrass	95	87
Zoysiagrass	90	80
Barley	98	90
Millet	99	80
Oats	98	80
Rye	98	85

*Seed containing prohibited or restricted noxious weed seeds as listed in the rules for the State Seed Law, NJAC. 2:21-4.1 et. seq., will not be accepted.

Prohibited noxious weed - Bindweed, Canada thistle, quackgrass, hedge bindweed, and horse nettle.

Restricted noxious weed seed - Wild garlic, bermudagrass, cheat, wild onion, corn cockle, dodder and wild onion, Johnsongrass, perennial sweet sudangrass, sorghum alnum and other perennial sorghum hybrids, grant required, but cucumber.

**Seed shall not contain in excess of 1.0 percent weed seed.

Table B-2 Grass, Legume and Shrub Planting Guide

COMMON NAME	SCIENTIFIC NAME	GROWTH HABIT 1/.	GROWTH SEASON 2/.	SOIL DRAINAGE TOLERANCE 3/.	pH RANGE	FLOOD TOLERANCE	SHADE TOLERANCE	SALT TOLERANCE	FOOT TRAFFIC	MAINTENANCE LEVELS 4/.
GRASSES										
Barley	<i>Hordeum vulgare</i>	Annual	cool	WD-MWD	5.5-7.8	No	No	Low	No	Moderate
Beachgrass, american	<i>Ammophila breveligulata</i>	PsR	cool	WD	5.5-7.5	Yes	No	High	No	Low
Bentgrass, creeping	<i>Agrostis stolonifera</i>	PsR	cool	MWD-PD	5.5-7.0	Yes	No	Low	No	High
Bermudagrass	<i>Cynodon dactylon</i>	PIS	warm	EXDR-SWPD	4.5-7.5	Yes	No	High	Yes	Moderate
Bluegrass, Canada	<i>Poa compressa</i>	PIR	cool	EXDR-SWPD	4.5-9.5	No	Yes	Low	Yes	Moderate-low
Bluegrass, Kentucky	<i>Poa pratensis</i>	PIR	cool	WD-SWPD	5.5-7.0	Yes	No	Mod.	Yes	High-low
Bluegrass, Rough	<i>Poa trivialis</i>	PsS	cool	MWD-SWPD	5.5-7.0	Yes	Yes	Low	Yes	Moderate-low
Bluestem, big	<i>Andropogon gerardii</i>	PIB	warm	EXDR-MWD	5.0-7.5	No	No	Low	No	Low
Bluestem, little	<i>Schizachyrium scoparium</i>	PIB	warm	EXDR-MWD	5.5-7.5	No	No	Low	No	Low
Canarygrass, reed	<i>Phalaris arundinacea</i>	PIR	cool	WD-PD	5.0-7.5	Yes	No	Low	No	Moderate-low
Coastal panicgrass	<i>Panicum amarulum</i>	PIB	warm	EXDR-PD	4.5-7.5	Yes	No	Mod.	No	Low
Cordgrass, saltmeadow	<i>Spartina patens</i>	PIR	warm	WD-PD	5.0-7.5	Yes	No	High	No	Low
Cordgrass, smooth	<i>Spartina alternifolia</i>	PIR	warm	PD	5.0-7.5	Yes	No	High	No	Low
Deertongue	<i>Dichanthelium clandestinum</i>	PIR	warm	EXDR-SWPD	3.8-5.0	Yes	No	Low	No	Low
Fescue, creeping red	<i>Festuca rubra</i>	PIR	cool	WD-SWPD	4.5-9.5	Yes	Yes	Low	Yes	Moderate-low
Fescue, hard	<i>Festuca longifolia</i>	PIB	cool	EXDR-WD	4.5-7.5	No	Yes	Low	Yes	Low
Fescue, tall	<i>Festuca arundinacea</i>	PIB	cool	WD-SWPD	5.0-8.0	Yes	Yes	Mod.	Yes	Moderate-low
Indiangrass	<i>Sorghastrum nutans</i>	PIB	warm	EXDR-WD	5.0-8.0	No	No	Low	No	Low
Lovegrass, sand	<i>Eragrostis trichodes</i>	PIB	warm	EXDR-WD	4.5-8.0	No	No	Low	No	Low

COMMON NAME	SCIENTIFIC NAME	GROWTH HABIT 1/.	GROWTH SEASON 2/.	SOIL DRAINAGE TOLERANCE 3/.	pH RANGE	FLOOD TOLERANCE	SHADE TOLERANCE	SALT TOLERANCE	FOOT TRAFFIC	MAINTENANCE LEVELS 4/.
Lovegrass, weeping	<i>Eragrostis curvula</i>	PsB	warm	EXDR-WD	4.5-8.0	No	No	Low	No	Low
Millet, pearl	<i>Pennisetum americanum</i>	Annual	warm	WD-SWPD	4.5-7.5	No	No	Low	No	Low
Millet, German (foxtail)	<i>Setaria italica</i>	Annual	warm	WD-SWPD	4.5-7.5	No	No	Low	No	Low
Oats	<i>Avena sativa</i>	Annual	cool	WD-SWPD	4.5-7.0	No	No	Low	No	Low
Redtop	<i>Agrostis gigantea</i>	PsR	cool	WD-PD	4.5-7.5	Yes	No	Low	Yes	Low
Rye, cereal	<i>Secale cereale</i>	Annual	cool	WD-MWD	4.5-7.0	No	No	Low	No	Low
Ryegrass, perennial	<i>Lolium perenne</i>	PsB	cool	WD-SWPD	5.5-7.5	No	No	Mod	No	High-Moderate
Saltgrass, alkali	<i>Puccinella distans</i>	PsB	cool	WD-SWPD	5.5-8.0	No	No	High	No	Moderate-Low
Switchgrass	<i>Panicum virgatum</i>	PIB	warm	EXDR-PD	4.5-7.5	Yes	No	High	No	Low
Wildrye	<i>Elymus virginicus</i>	PIB	cool	MWD-PD	5.0-7.0	Yes	Yes	Mod	No	Low
Zoysiagrass	<i>Zoysia japonica</i>	PIS	warm	WD-MWD	5.0-7.0	No	No	High	Yes	Low
<u>LEGUMES</u>										
Birdsfoot trefoil	<i>Lotus corniculatus</i>	PIR	cool	EXDR-SWPD	5.0-7.5	Yes	No	Low	No	Low
Clover, white	<i>Trifolium repens</i>	PIR	cool	WD-SWPD	5.5-7.5	No	No	Low	Yes	Low
Crownvetch	<i>Coronilla varia</i>	PIR	cool	WD-MWD	5.5-7.5	No	No	Low	No	Low
Flatpea	<i>Lathyrus sylvestris</i>	PIR	cool	EXDR-MWD	4.0-7.0	No	No	Mod.	No	Low
Lespedeza, serecia	<i>Lespedeza cuneata</i>	PIB	warm	EXDR-MWD	5.5-7.0	No	No	Low	No	Low
Partridge pea	<i>Cassia fasciculata</i>	Annual	warm	EXDR-MWD	5.0-7.0	No	No	Mod.	No	Low
<u>SHRUBS</u>										
Dogwood, redosier	<i>Cornus serecia</i>	PIR	N/A	MWD-PD	4.5-7.0	Yes	Yes	Low	N/A	Low
Dogwood, silky	<i>Cornus amomum</i>	PIR	N/A	WD-PD	4.0-7.0	Yes	Yes	Low	N/A	Low
Willow, purpleosier	<i>Salix purpurea</i>	PIR	N/A	WD-PD	4.5-7.5	Yes	No	Low	N/A	Low

COMMON NAME	SCIENTIFIC NAME	GROWTH HABIT 1/.	GROWTH SEASON 2/.	SOIL DRAINAGE TOLERANCE 3/.	pH RANGE	FLOOD TOLERANCE	SHADE TOLERANCE	SALT TOLERANCE	FOOT TRAFFIC	MAINTENANCE LEVELS 4/.
Willow, dwarf	<i>Salix cottetii</i>	PIR	N/A	WD-PD	4.5-7.0	Yes	No	Low	N/A	Low

FOOTNOTES

1/. Growth Habit:

- P-perennial
- l-long-lived
- s-short-lived
- R-rhizomatous
- S-stoloniferous
- B- bunch

2/. Growth Season:

Cool - major portion of growth during early spring and early fall

Warm - major portion of growth during summer months

3/. Soil Drainage Tolerance:

EXDR - excessively drained

WD - well-drained

MWD - moderately well-drained

SWPD - somewhat poorly drained

PD - poorly drained

4/.Maintenance Levels:

Low - requiring infrequent mowing and little or no fertilizer or lime for long-term persistence

Moderate - requiring some mowing and medium amounts of fertilizer and lime for long-term persistence

High - requires frequent mowing and high levels of fertilizer and lime for long-term persistence

CHAPTER 24 OF TITLE 4, REVISED STATUTES OF NEW JERSEY

SOIL CONSERVATION

ARTICLE 1. DECLARATION OF POLICY

4:24-1. Legislative policy declared

It is hereby declared to be the policy of the legislature to provide for the conservation of the soil and soil resources of this state, and for the control and prevention of soil erosion.

4:24-1.1 Prevention of damage by flood water or sediment; conservation of water for agricultural purposes

The purposes of soil conservation and the control and prevention of soil erosion to be furthered by the State Soil Conservation Committee and of the soil conservation districts shall include, wherever applicable, the prevention of damage to soil and soil resources by floodwater or by sediment and the furtherance of conservation of water for agricultural purposes.

L 1959,c. 129, §3, p. 570. eff. July 1, 1959

ARTICLE 2. DEFINITIONS

4:24-2. Words and phrases defined

Wherever used or referred to in this chapter, unless a different meaning clearly appears from the context:

- a. "District" or "soil conservation district" means a governmental subdivision of this state, and a public body corporate and politic, organized in accordance with the provisions of

this chapter, for the purposes, with the powers, and subject to the restrictions hereinafter set forth;

- b. "Supervisor" means one of the members of the governing body of a district, appointed in accordance with the provisions of this chapter;
- c. "Committee" or "state soil conservation committee" means the agency created in article three of this chapter;
- d. "Petition" means a petition filed under the provisions of article 4 of this chapter (§4:24-7 et seq.) for the creation of a district;
- e. "State" means the state of New Jersey;
- f. "Agency of this state" includes the government of this state and any subdivision, agency, or instrumentality, corporate or otherwise, of the government of this state;
- g. "United States" or "agencies of the United States" includes the United States of America, the soil conservation service of the United States department of agriculture, and any other agency or instrumentality, corporate or otherwise, of the United States of America;
- h. "Government" or "governmental" includes the government of this state, the government of the United States, and any subdivision, agency or instrumentality, corporate or otherwise, of either of them;
- i. "Landowner" includes any person, firm or corporation who shall hold title to any lands lying within a district organized under the provisions of this chapter;
- j. "Due notice" means notice published at least twice, with an interval of at least seven days between the two publication dates, in a newspaper or other publication of general circulation within the appropriate area, or if no such publication of general circulation be available, by posting at a reasonable number of conspicuous places, within the appropriate area, such posting to include, where possible, posting at public places where it may be customary to post notices concerning county or municipal affairs generally. At any hearing held pursuant to such notice, at the time and place designated in such notice, adjournment may be made from time to time, without the necessity of renewing such notice for such adjourned dates.

L 1959, c. 139, §201, p. 319.

ARTICLE 3. STATE SOIL CONSERVATION COMMITTEE

4:24-2.1 Transfer of functions, powers and duties to Department of Agriculture

The State Soil Conservation Committee and all of its functions, powers and duties are hereby transferred to the Department of Agriculture.

L 1959, c. 129, p.570, eff July 1, 1959.

4:24-3 Committee established; membership, records; seals; hearings; rules and regulations

There is hereby established, to serve as an agency of the State and to perform the functions conferred upon it in this chapter, the State Soil Conservation Committee. The committee shall consist of 11 members: The Director of the New Jersey Agricultural Experiment Station, the associate director of the Cooperative Extension Service in Agriculture and Home Economics, the State Secretary of Agriculture, the commissioner of the Department of Conservation and Economic Development or a representative designated by any 1 of these individuals, and 1 member appointed by the Governor to serve at his pleasure. Six members shall be soil conservation district supervisors, who shall be elected at the annual meetings of soil conservation district supervisors, for terms of 3 years and until their successors are appointed and qualified. Three supervisors shall be elected from the northern region which is composed of the counties of Bergen, Essex, Hudson, Hunterdon, Middlesex, Monmouth, Morris, Passaic, Somerset, Sussex, Union and Warren and 3 supervisors shall be elected from the southern region which is composed of the counties of Atlantic, Burlington, Camden, Cape May, Cumberland, Gloucester, Mercer, Ocean and Salem. Of the first 3 members from each region 1 shall be elected for 1 year, 1 for 2 years, and 1 for 3 years. The committee shall invite the secretary of agriculture of the United States of America to appoint 1 person, a resident of the State of New Jersey, to serve with the above-mentioned members. The committee shall keep a record of its official actions, shall adopt a seal, which seal shall be judicially noted, and may perform such acts, hold such public hearings, and promulgate such rules and regulations as may be necessary for the execution of its functions under this chapter.

L 1937, c. 139, §301, p. 321, amended by L 1959, c. 130. §1., p. 571.

4:24-3.1 Election of Members

The first election for members of the State Soil Conservation Committee, established under this act, shall be held by the State Soil Conservation Committee in office on the effective date of this act. This election shall be held within 10 days after the effective date of this act.

L 1959, c. 130, §3, p.572, eff. June 18, 1959.

4:24-4 Administrative officer and employees; legal services; cooperative agreements

The State Soil Conservation Committee may employ, subject to the rules of the State Civil Service Commission, a qualified administrative officer and such technical experts and such other agents and employees, permanent and temporary, as it may require, and shall determine their qualifications, duties and compensation of all employees. The committee shall call upon the Attorney General for such legal services as it may require for the purpose of carrying out any of its functions. The committee may enter into a cooperative agreement with any other State agency. The members of the committee who are soil conservation district supervisors shall not vote on or participate in the employment or selection of any officers, agents or employees, and for such purpose the membership of the committee shall be deemed to be 5.

L 1937, c. 139, §302, p. 321, amended by L 1959, c. 130, §2, p. 572, eff June 18, 1959.

4:24-5 Organization; term of members; quorum; expenses; surety bonds for employees; records; audit

The committee shall designate its chairman, and may, from time to time, change such designation. A member of the committee shall hold office so long as he shall retain the office by virtue of which he shall be serving on the committee. A majority of the committee shall constitute a quorum, and the concurrence of a majority in any matter within their duties shall be required for its determination. The chairman and members of the committee shall receive no compensation for their services on the committee, but shall be entitled to expenses, necessarily incurred in the discharge of their duties on the committee. The committee shall provide for the

execution of surety bonds for all employees and officers who shall be instructed with funds or property; shall provide for the keeping of a full and accurate record of all proceedings and of all resolutions, regulations, and orders issued or adopted; and shall provide for an annual audit of the accounts of receipts and disbursements.

L 1937, c. 139, §303, p. 321.

4:24-6. Powers and duties of committee

In addition to the duties and powers hereinafter conferred upon the state soil conservation committee it shall have the following duties and powers:

- a. To accept from the United States or any of its agencies, contributions in services, materials, money or otherwise, and to use or expend such contribution in the formulation of comprehensive plans for the conservation of soil resources and the prevention of soil erosion within the state and to conduct surveys, investigations, demonstrations, and research relating to soil erosion and the preventive measures needed in areas subject to erosion by wind and water, to publish results of any such surveys, investigations or research and to disseminate information. In order to avoid duplication of research, demonstration, and the dissemination of information, no program of such activities shall be carried on except in cooperation with the state agricultural college and the state agricultural experiment stations, or such other state agency as may be dealing with allied problems;
- b. To offer such assistance to the supervisors of soil conservation districts, organized as provided hereinafter as may be appropriate in the carrying out of any of their powers and programs;
- c. To coordinate the programs of the several soil conservation districts organized hereunder;
- d. To secure the cooperation and assistance of the United States and any of its agencies; and of agencies of this state, in the work of such districts;
- e. To disseminate information throughout the state concerning the activities and programs of the soil conservation districts organized hereunder, and to encourage the formation of such districts in areas where their organization is desirable.

L 1937, c. 139, §4, p. 33.

4:24-6.1 Review and approval, modification, or rejection of decision

The committee may, on its own motion or at the request of any person aggrieved by any decision by a local district, review and approve, modify or reject any such decision as it deems appropriate.

L 1979, c. 459, § eff. February 27, 1980.

ARTICLE 4. CREATION OF SOIL CONSERVATION DISTRICTS

4:24-7 through 4:24-17 Repealed by L 1977, c. 264, §4.

ARTICLE 4A. SOIL CONSERVATION DISTRICTS: DIVISION INTO SEPARATE DISTRICTS AND CONSOLIDATION OF DISTRICTS

4:24-17.1 Public hearings

Whenever the supervisors of a soil conservation district which has been created for more than one year determine it advisable to divide the district into two or more separate districts, or whenever the supervisors of two or more contiguous districts determine it advisable to combine such districts, the supervisors or the district or districts shall call a public hearing on such proposal.

L 1966, c. 77 §1, eff. June 14, 1966.

4:24-17.2 Resolution requesting approval; procedure upon approval

Following such public hearing the supervisors of the district or districts may adopt a resolution requesting such approval by the State Soil Conservation Committee of a division of the district or the combination of separate districts into a single district, the proposed

boundaries of the proposed district or districts being annexed to said resolutions. If the State Soil Conservation Committee approves the proposal and so notifies the supervisors, the supervisors shall file with the Secretary of State a statement or statements setting forth the revised name of names and boundaries of the district or districts so approved and the date upon which such changes are to become effective.

L 1966, c. 77 §2, eff. June 14, 1966.

4:24-17.3 New supervisors; appointment; time of taking office

Upon the effective date of a division of a district or the combination of two or more districts, the terms of office of the supervisors theretofore in office shall terminate and new supervisors, appointed by the State Soil Conservation Committee in accordance with Revised Statutes 4:24-12, shall take office as the governing body of the district or districts so created.

L 1966, c. 77 §3, eff. June 14, 1966.

4:24-17.4 Continuance of contracts, liabilities, regulations and other matters; assumption by new district

The State Soil Conservation Committee shall make such provisions as are necessary for the continuance in effect of all contracts, liabilities, regulations and other matters of the district or districts to be divided or combined and shall designate the manner in which these contracts, liabilities, regulations and other matters are to be assumed by the districts simultaneously with its granting of approval for divisions or combining of a district.

L 1966, c. 77 §4, eff. June 14, 1966.

4:24-17.5 County and multi-county soil conservation districts; creation

The whole area of the State shall, at all times, be covered by a soil conservation district. Each soil conservation district shall cover the whole area of one or more counties. A tri-county soil conservation district shall serve the counties of Hudson, Essex and Passaic to be known as

the Hudson, Essex and Passaic Soil Conservation District. Bi-county soil conservation districts shall serve the following pairs of counties: Middlesex-Monmouth, Somerset-Union, and Cape May- Atlantic, to be known as the Freehold, Somerset-Union, and Cape-Atlantic Soil Conservation Districts respectively. Every other county in the State shall be served by its own soil conservation district to be known as “the County Soil Conservation District: with the name of each such county inserted. The State Soil Conservation Committee shall work with the supervisors of the multi-county soil conservation districts to encourage the formation of a soil conservation district in each county of the State, pursuant to the procedures contained in P.L. 1966, c. 77 (C. 4:24-17.1 et seq.).

L 1979, c. 264, §3, eff. October 18, 1977.

4:24-17.6 Appropriation of funds by counties

Any board of chosen freeholders may appropriate such funds as it deems necessary to the soil conservation district serving that county for the purpose of providing district services to the people of that county.

L 1979, C. 459, §5, eff. February 27, 1980.

4:24-17.7 Legal services to district by Attorney General

The Attorney General, on his own initiative, or the respective county counsel, with the approval of the board of chosen freeholders, may provide any and all legal services to any district.

L 1979, c. 459, §5, eff. February 27, 1980.

ARTICLE 5. APPOINTMENT, QUALIFICATIONS AND TENURE OF SUPERVISORS

4:24-18. Governing body of district; supervisors; appointment

The governing body of the district shall consist of five supervisors, appointed by the State Soil Conservation Committee. The five supervisors shall be legal residents of the district.

L 1937, c. 139, §501, p. 330, amended by L 1966, c. 77, eff. June 14, 1966, amended by L 1977, c. 264, §1, eff. October 18, 1977.

4:24-19. Supervisors; chairman; term of office; quorum; per diem

The supervisors shall designate a chairman and may, from time to time, change such designation. The term of office of each supervisor shall be at the pleasure of the State committee. The selection of successors shall be made in the same manner in which the retiring supervisor shall have been selected. A majority of the supervisors shall constitute a quorum and the concurrence of a majority in any matter within their duties shall be required for its determination. A supervisor shall be entitled to expenses, and a per diem in an amount to be established by the State committee within the limits of available appropriations, when engaged in the performance of his duties.

L 1937, c. 139, §502, p. 330, amended by L 1979, c. 459, §6, eff. Feb. 27, 1980.

4:24-20. Officers and employees; information to state committee

The supervisors may employ, subject to the approval of the state committee, technical experts, and such other officers, agents, and employees, permanent and temporary, as they may require, and shall determine their qualifications, duties, and compensation. The supervisors may delegate to their chairman, to one or more supervisors, or to one or more agents, or employees, such powers and duties as they may deem proper. The supervisors shall furnish to the State Soil Conservation Committee, upon request, copies of such ordinances, rules, regulations, orders, contracts, forms, and other documents as they shall adopt or employ, and

such other information concerning their activities as it may require in the performance of its duties under this chapter.

L 1937, c. 139, §503, p. 330.

4:24-21. Surety bonds for officers and employees; records; annual audit

The supervisors may provide for the execution of surety bonds for any employees and officers who shall be entrusted with funds or property; shall provide for the keeping of a full and accurate record of all proceedings and of all resolutions, regulations, and orders issued or adopted' and shall provide for an annual audit of the accounts of receipts and disbursements.

L 1937, c. 139, §504, p. 330.

ARTICLE 6. POWERS OF DISTRICTS AND SUPERVISORS

4:24-22. District a governmental subdivision and body corporate; enumeration of powers of districts and supervisors

A soil conservation district organized under the provisions of this chapter shall constitute a governmental subdivision of this State, and a public body corporate and politic, exercising public powers, and such district, and the supervisors thereof, shall have the following powers, in addition to others granted in other sections of this chapter:

- a. To conduct surveys, investigations, and research relating to the character of soil erosion and the preventive and control measures needed, to publish the results of such surveys, investigations, or research, and to disseminate information concerning such preventive and control measures; provided, however, that in order to avoid duplication of research program except in cooperation with the agricultural experiment stations or any other agency of this State, as may be dealing will allied problems;

- b. To conduct in cooperation with existing State agencies, projects within the district on lands owned or controlled by this State or any of its agencies, with the cooperation of the agency administering and having jurisdiction thereof, and on any other lands within the district upon obtaining the consent of the owner thereof, or those who have rights or interests in such lands, in order to demonstrate methods of soil erosion control;
- c. To carry out preventive and control measures within the district including but not limited to, engineering operations, methods of cultivation, the growing of vegetation, changes in use of land, on lands owned or controlled by this State or any of its agencies, with the cooperation of the agency administering and having jurisdiction thereof, and on any other lands within the district;
- d. To cooperate, or enter into agreements with, and within the limits of appropriations duly made available to it by law, to furnish financial or other aid to, any agency, governmental or otherwise, or any owner of lands within the district, in the carrying on of erosion control and prevention operations within the district, subject to such conditions as the supervisors may deem necessary to advance the purposes of this chapter;
- e. To acquire machinery and other necessary personal property, to make provision for its safekeeping and to dispose of said property when no longer needed;
- f. To make available, on such terms as it shall prescribe, to landowners within the district, agricultural and engineering machinery and equipment, as will assist such landowners to carry on operations upon their lands for the conservation of soil resources and for the prevention and control of soil erosion;
- g. To construct, improve, and maintain such structures as may be necessary or convenient for the performance of any of the operations authorized in this chapter;
- h. To develop comprehensive plans for the conservation of soil resources and for the control and prevention of soil erosion within the district, which plans shall specify in such detail as may be possible, the acts, procedures, performances, and avoidances which are necessary or desirable for the effectuation of such plans, including the specifications of engineering operations, methods of cultivation, the growing vegetation, cropping programs, tillage practices, and changes in use of land; and to publish such plans and information and bring them to the attention of owners of lands within the district;

- i. To develop site plans for the construction, operation and maintenance of proposed leaf composting facilities located on agricultural or horticultural required pursuant to Section 7 of P.L. 89, c. 151 and to conduct an annual inspection of each operational facility within the district authorized by the Department of Environmental Protection in order to certify to the department that the facility is in compliance with the rules and regulations adopted by the department therefor and is operating in conformance with recommended agricultural management practices;
- j. To act as agent for the United States, or any of its agencies, or for this State or any of its agencies, in connection with any soil-conservation, erosion-control, or erosion-prevention project within its boundaries; to accept payments, donations, gifts, and contributions in money, services, materials, or otherwise from the United States or any of its agencies, or from this State or any of its agencies, or from any governmental subdivision or its agencies or from any corporation, association, group or individual, and to use or expend such moneys, services, materials, or other contributions in carrying out its operations;
- k. To sue and be sued in the name of the district; to have a seal, which seal shall be judicially noticed; to have perpetual succession unless terminated as hereinafter provided; to make and execute contracts and other instruments, necessary or convenient to the exercise of its powers; to make, and from time to time amend and repeal, rules and regulations, not inconsistent with this chapter, to carry into effect its purposes and powers;
- l. To acquire, by gift, devise, purchase or condemnation, any real property located within the district, or any interest or estate therein, which is required for the proper exercise by the district of its powers; provided, however, that the district shall not acquire any real property, or interest or estate therein, by condemnation without first obtaining the approval of the Secretary of Agriculture and the Commissioner of Environmental Protection;
- m. As a condition to the extending of any benefits under this chapter, to, or the performance of work upon, any lands not owned or controlled by this State or any of its agencies, the supervisors may require contributions in money, services, materials, or otherwise to any operations conferring such benefits and may require landowners to

enter into and perform such agreements or covenants as to the permanent use of such lands as will tend to prevent or control erosion thereon;

- n. To borrow money for the purchase of equipment, either with or without security;
- o. No provision with respect to the acquisition, operations, or disposition of property by other public bodies shall be applicable to a district organized hereunder unless the Legislature shall specifically so state.

L 1937, c. 139, §601, p. 331, amended by L 1957, c. 48, §1, p. 90;

L 1960, c. 20, §1, p. 79; L 1966, c. 77, §6, eff. June 14, 1966;

L 1989, c. 151, §7.

4:24-22.1 Site plan for leaf composting facility; contents; certification; annual inspections

- a. Every Soil Conservation District shall develop a site plan for each proposed leaf composting facility to be located on agricultural or horticultural land, or on lands owned or operated by a recognized academic institution, within the district. The site plan shall include such information as may be prescribed by the Department of Environmental Protection and shall be certified in a manner as may be prescribed by the department.
- b. Every Soil Conservation District shall conduct an annual inspection of each operational leaf composting facility located on agricultural or horticultural land, or on lands owned or operated by a recognized academic institution, within the district and authorized by the department in order to certify to the department that the facility is operated and maintained in compliance with the rules and regulations adopted by the department therefore and the site plan developed by the district, and in conformance with recommended agricultural management practices.

L 1898, c. 151, §7, eff. August 9, 1989.

4:24-22.2 Leaf composting facility located on agricultural or horticultural land or on lands of academic institution; method of operation

Each leaf composting facility located on agricultural or horticultural land, or on lands owned or operated by a recognized academic institution, shall operate in accordance with the conditions specified in the program of agricultural management practices developed by the New Jersey Cooperative Extension Service of Rutgers, The State University, and approved by the department.

L 1989, c. 151 §8, eff. August 9, 1989.

(Editorial Note: In Sections 22.1 and 22.2 the word department means the New Jersey Department of Environmental Protection)

ARTICLE 7. ADOPTION OF LAND-USE REGULATIONS

4:24-23. Supervisors to formulated regulations; public hearings; submission to state committee; objections by landowners

The supervisors of any district shall have the authority to formulate regulations governing the use of lands within the district in the interest of conserving soil and soil resources and preventing and controlling soil erosion. The supervisors shall conduct such public meetings and public hearings upon tentative regulations as may be necessary to assist them in this work. After such hearings the supervisors shall draft such land-use regulations as seem to them necessary to carry out the provisions of this chapter. These regulations shall then be submitted to the State Soil Conservation Committee which may within thirty days suggest amendments thereto for consideration by the supervisors. Thereinafter the supervisors shall give due notice of the regulations by publication and by posting. Any landowner may, for a period of sixty days thereafter, file with the supervisors his objections to the adoption of said regulations, said objections shall be made upon a form to be furnished by the supervisors. If objections are filed by owners of at least twenty-five percent of the acreage of the district, the supervisors shall not have the authority to enact said regulations, otherwise the supervisors shall thereupon take such affirmative action as may be necessary to make such land-use regulations effective. Land-

use regulations adopted pursuant to the provisions of this article shall be binding on all landowners within such district.

L 1937, c. 139, §701, p. 333

4:24-24. Amendment, etc., of regulations

Any owner of land within such district may at any time file a petition with the supervisors asking that any or all of the land-use regulations adopted by the supervisors under the provisions of this article shall be amended, supplemented, or repealed. Land-use regulations adopted pursuant to the provisions of this article shall not be amended, supplemented, or repealed except in accordance with the procedure prescribed in this article for adoption of land-use regulations.

L 1937, c. 139, §702, p. 334.

4:24-25. Provisions which may be included into regulations

Regulations to be adopted by the supervisors under the provisions of this article may include:

- a. Provisions requiring the construction of terraces, terrace outlets, check dams, dikes, ponds, ditches, and other necessary structures;
- b. Provisions requiring observance of particular methods of cultivation including contour cultivating, contour furrowing, lister furrowing, sowing, planting, strip cropping, seeding, and planting of lands to water-conserving and erosion-preventing plants, trees and grasses, forestation and reforestation;
- c. Specifications of cropping programs and tillage practices to be observed;
- d. Provisions limiting the cultivation of highly erosive areas or of areas on which erosion may not be adequately controlled if cultivation is carried on;
- e. Provisions for such other means, measures, operations and programs as may assist conservation of soil resources and prevent or control soil erosion in the district.

L 1937, c. 139, §704, p. 335.

4:24-26. Regulations to be uniform; printing of copies

The regulations shall be uniform throughout the territory comprised within the district except that the supervisors may classify the lands within the district with reference to such factors as soil type, degree of slope, degree of erosion threatened or existing, cropping and tillage practices in use, and other relevant factors, and may provide regulations varying with the type or class of land affected, but uniform as to all lands within each class or type. Copies of land-use regulations adopted under the provisions of this article shall be printed and made available to all owners and occupiers of lands lying within the district.

L 1937, c. 139, §704, p. 335.

ARTICLE 8. ENFORCEMENT OF LAND-USE REGULATIONS

4:24-27. Authority of supervisors; suit for damages by landowner for violations

The supervisor shall have authority to go upon any lands within the district to determine whether land-use regulations adopted under the provisions of article seven of this chapter (§4:24-23 et seq) are being observed. Any landowner who shall sustain damages from any violation of such regulations by any other landowner may sue to recover damages in a civil action from such other landowner for such violation.

L 1937, c. 139, §801, p. 335, amended by L 1953, c. 5, §100, p. 56.

ARTICLE 9. PERFORMANCE OF WORK UNDER REGULATIONS BY SUPERVISORS

4:24-28. Nonobservance of land-use regulations; action

Where the supervisors of any district shall find that any of the provisions of land-use regulations adopted in accordance with the provisions of article seven of this chapter (§4:24-23 et seq.) are not being observed on particular lands, and that such nonobservance tends to

increase erosion on such lands and is interfering with the prevention or control of erosion on other lands within the district, the supervisors may bring an action in the Superior Court and the said court therein may grant appropriate relief.

L 1937, c. 139, §901, p. 335, amended by L 1953, c. 5, §101, p. 56.

4:24-29. Repealed by L 1953, c. 5, §102, p. 56.

ARTICLE 10. BOARD OF ADJUSTMENT

4:24-30. Members; appointment, term, removal, etc., expenses

Where the supervisors of any district organized under the provisions of this chapter shall adopt land-use regulations in accordance with the provisions of article 7 of this chapter (§4:24-23 et seq.), they shall further provide for the establishment of a board of adjustment. Such board of adjustment shall consist of three members, each to be appointed for a term of three years, except that the members first appointed shall be appointed for terms of one, two and three years, respectively. The members of each such board of adjustment shall be appointed by the State Soil Conservation Committee, with the advice of the supervisors of the district for which such board has been established, and shall be removable, upon notice and hearing, for neglect of duty or malfeasance in office, but for no other reason, such hearing to be conducted by the State Soil Conservation Committee. Vacancies in the board of adjustment shall be filled in the same manner as original appointments, and shall be for the unexpired term. Members of the State Soil Conservation Committee and the supervisors of the district shall be ineligible to appointment as members of the board of adjustment during their tenure of such other office. The members of the board of adjustment shall receive no compensation for their services, but they shall be entitled to expenses, necessarily incurred in the discharge of their duties. The supervisors shall pay the necessary administrative and other expenses incurred by the board, upon the certificate of the chairman of the board.

L 1937, c. 139, §1001, p. 337.

4:24-31. Rules by board; organization; meetings; oaths and witnesses; records

The board of adjustment shall adopt rules to govern its procedures, which rules shall be in accordance with the provisions of this chapter. The board shall designate a chairman from among its members, and may, from time to time, change such designation.

4:24-32. Petition by landowner to board for variance in land-use regulations; procedure

Any landowner may file a petition with the board of adjustment alleging that there are great practical difficulties or unnecessary hardship in the way of his carrying out upon his lands the strict letter of the land-use regulations approved by the supervisors, and praying the board to authorize a variance from the terms of the land-use regulations in the application of such regulations to the lands of the petitioner. Copies of such petition shall be served by the petitioner upon the chairman of the supervisors of the district within which his lands are located and upon the chairman of the State Soil Conservation Committee. The board of adjustment shall fix a time for the hearing of the petition and cause due notice to be given. The supervisors of the district and the State Soil Conservation Committee shall have the right to appear and be heard at such hearing. Any owner of lands lying within the district who shall object to the authorizing of the variance prayed for may intervene and become a party to the proceedings. Any party to the hearing before the board may appear in person, by agent, or by attorney. If, upon the facts presented at such hearing, the board shall determine that there are great practical difficulties or unnecessary hardship in the way of applying the strict letter of any of the land-use regulations, in their application to the lands of the petitioner, as will relieve such great practical difficulties or unnecessary hardship and will not be contrary to the public interest, and such that the spirit of the land-use regulations shall be observed, the public health, safety, or welfare secured, and substantial justice done.

L 1937, c. 139, §1003, p. 338.

4:24-33. Review of order of board

Any petitioner aggrieved by an order of the board granting or denying, in whole or in part, the relief sought of the supervisors of the district, or any intervening party, shall be entitled to a review of such order in the Superior Court by a proceeding in lieu of prerogative writ.

L 1937, c. 139, §1004, p. 339, amended by L 1953, c. 5, §103, p. 56.

ARTICLE 11. COOPERATION WITH STATE AGENCIES

4:24-34. Duty of state agencies, counties, etc., to cooperate

It shall be the duty of all agencies of this state which shall have jurisdiction over, or be charged with the administration of, any state-owned lands, and of any county, or other governmental subdivision of the state, which shall have jurisdiction over, or be charged with the administration of, any county-owned or other publicly owned lands, lying within the boundaries of any district organized hereunder, to cooperate to the fullest extent compatible with the purposed for which such lands are held.

L 1937, c. 139, §1101, p. 339.

ARTICLE 12. DISCONTINUANCE OF DISTRICTS

4:24-35 THROUGH 4:24-38 Repealed by L 1977, c. 264, §4.

ARTICLE 13. SOIL EROSION AND SEDIMENT CONTROL

4:24-39. Short title

This act may be cited and referred to as the "Soil Erosion and Sediment Control Act."

L 1975, c. 251, §1, eff. January 1, 1976.

4:24-40. Legislative findings

The Legislature finds that sediment is a source of pollution and that soil erosion continues to be a serious problem throughout the State, and that rapid shifts in land use from agricultural and rural to nonagricultural and urbanizing uses, construction of housing, industrial and commercial developments, and other land disturbing activities have accelerated the process of soil erosion and sediment deposition resulting in pollution of the waters of the State and damage to domestic, agricultural, industrial, recreational, fish and wildlife, and other resource uses. It is, therefore, declared to be the policy of the State to strengthen and extend the present erosion and sediment control activities and programs of this State for both rural and urban lands, and to establish and implement, through the State Soil Conservation Committee and the Soil Conservation Districts, in cooperation with the counties, the municipalities and the Department of Environmental Protection, a Statewide comprehensive and coordinated erosion and sediment control program to reduce the danger from storm water runoff, to retard nonpoint pollution from sediment and to conserve and protect the land, water, air, and other environmental resources of the State.

L 1975, c. 251, §2, eff. January 1, 1976.

4:24-41. Definitions

- a. "Application for development: means a proposed subdivision of land, site plan, conditional use zoning variance, planned unit development or construction permit.
- b. "Certification" means (1) a written endorsement of a plan for soil erosion and sediment control by the local Soil Conservation District which indicates that the plan meets the standards promulgated by the State Soil Conservation Committee pursuant to this act;

- (2) that the time allotted in section 7 of this act (§4:24-45) has expired without action by the district; (3) a written endorsement of a plan filed by the State Department of Transportation with the district.
- c. "District" means a Soil Conservation District organized pursuant to chapter 24 of Title 4 of the Revised Statutes (§4:24-39 et seq.)
 - d. "Disturbance" means any activity involving the clearing, excavation, storing, grading, filling or transporting of soil or any other activity which causes soil to be exposed to the danger of erosion.
 - e. "Erosion" means the detachment and movement of soil or rock fragments by water, wind, ice and gravity.
 - f. "Plan" means a scheme which indicates land treatment measures, including a schedule of the time for their installation, to minimize soil erosion and sedimentation.
 - g. "Project" means any disturbance of more than 5,000 square feet of the surface area of land (1) for the accommodation of construction for which the State Uniform Construction Code would require a construction permit, except that the construction of a single-family dwelling unit shall not be deemed a 'project' under this act unless such unit is part of a proposed subdivision, site plan, conditional use, zoning variance, planned development or construction permit application involving two or more such single-family dwelling units; (2) for the demolition of one or more structures; (3) for the construction of a parking lot; (4) for the construction of a public facility; (5) for the operation of any mining or quarrying activity; or (6) for the clearing or grading of any land for other than agricultural or horticultural purposes.
 - h. "Sediment" means solid material, mineral or organic, that is in suspension, is being transported, or has been moved from its site or origin by air, water or gravity as a product of erosion.
 - i. "Soil" means all unconsolidated mineral and organic material of any origin.
 - j. "Standards" means the standards promulgated by the committee pursuant to this act.
 - k. "Committee" means the State Soil Conservation Committee in the Department of Agriculture established pursuant to R.S. 4:24-3.
 - l. "Public facility" means any building; pipeline; highway; electricity, telephone or other transmission line; or any other structure to be constructed by a public utility, municipality, county or the State or any agency or instrumentality thereof.

L 1975, c. 251, §3, eff. January 1, 1976, amended by L 1977, c. 264, §2, eff. October 18, 1977, L1979, c. 459, §1, eff. February 27, 1980.

4:24-42. Standards for control of soil erosion and sedimentation; promulgation, amendment and repeal

The committee shall have the power, subject to the approval of the Secretary of Agriculture and the Commissioner of Environmental Protection, to formulate, promulgate, amend and repeal standards for the control of soil erosion and sedimentation, pursuant to the Administrative Procedures Act, P.L. 1968, c. 410 (C. 52:14B-1 et seq.)

- a. Such standards shall be based upon relevant physical and developmental information concerning the watersheds and topography of the State, including, but not limited to, data relating to land use, soil, slope, hydrology, geology, size of land area being disturbed, proximate water bodies and their characteristics.
- b. Such standards shall include criteria, techniques and methods for the control of erosion and sedimentation resulting from land disturbing activities for various categories of soils, slopes, and land uses.
- c. Such standards shall include standards of administrative procedure for the implementation of this act.

L 1975, c. 251, §4, eff. November 12, 1975, amended by L 1979, c. 459, §2, eff. February 27, 1980.

4:24-43. Certification of plan by district; development of projects

Approval of an application for development for any project by the State, any county, municipality, or any instrumentality thereof shall be conditioned upon certification by the local district of a plan for soil erosion and sediment control. Any person proposing to engage in any project not requiring approval by the State, any county, municipality, or any instrumentality thereof shall, prior to commencing such project, receive certification by the local district of a plan for soil erosion and sediment control. Any public utility, municipality, county or the State or any agency or instrumentality thereof, other than the State Department of Transportation ,

which proposes a project shall, prior to the construction of such project submit to and receive certification by the district of a plan for soil erosion and sediment control. The State Department of Transportation shall certify a plan for any project that it proposes to construct and shall file such certification with the district. Certification by the Department of Transportation shall be pursuant to soil erosion control standards developed jointly by the Department of Transportation, the Department of Environmental Protection and the committee and promulgated by the Department of Transportation.

L 1975, c. 251, §5, eff. January 1, 1976, amended by L 1979, c. 459, §3, eff. February 27, 1980.

4:24-44. Certification of plan; criteria; notice

The district shall certify such plan if it meets the standards promulgated by the committee pursuant to this act. The district shall provide written notice to the applicant indicating that:

- a. the plan was certified;
- b. the plan was certified subject to the attached conditions; or
- c. the plan was denied certification with the reasons for denial stated.

L 1975, c. 251, §6, eff. January 1, 1976.

4:24-45. Limitation on time for grant or denial of certification

The district shall grant or deny certification within a period of 30 days of submission of a complete application unless, by mutual agreement in writing between the district and the applicant, the period of 30 days shall be extended for an additional period of 30 days. Failure of the district to grant or deny certification within such period or such extension thereof shall constitute certification. For purposes of this section, a major revision of the plan by the applicant shall constitute a new submission.

L 1975, c. 251, §7, eff. January 1, 1980.

4:24-46. Fees

The district shall adopt a fee schedule and collect fees from applicants for the certification of plans and for on-site inspections of the execution of certified plans. Such fees shall bear a reasonable relationship to the cost of rendering such services.

L 1975, c. 251, §7, eff. January 1, 1976.

4:24-47. Stop-construction order; failure to comply with certified plan

The district or the municipality may issue a stop-construction order if a project is not being executed in accordance with a certified plan.

L 1975, c. 251, §9, eff. January 1, 1976.

4:24-48. Exempt municipalities

Any municipality, which adopts an ordinance that conforms to the standards promulgated pursuant to this act within 12 months of their promulgation and obtains the approval of the committee thereto, shall be exempt from sections 5 through 9 of this act (§4:24-43 to 4:24-47), until such time as the local district determines that the municipality is not enforcing said ordinance.

L 1975,c. 251, §10, eff. January 1, 1976.

4:24-49. Certificate of occupancy for project; conditions for issuance

No certificate of occupancy for a project shall be issued by a municipality or any other public agency unless there has been compliance with the provisions of a certified plan for permanent measures to control soil erosion and sedimentation.

L 1975, c. 251, §11, eff. January 1, 1976, amended by L 1979, c. 459, §10, eff. February 27, 1980.

4:24-50. County planning board as agent for district

In those counties where the district does not maintain its central office, the board of freeholders may, by resolution, direct the county planning board to act as an agent of the district within that county and to administer the powers granted to the district pursuant to this act, until such time as a district is established within that county. The committee shall establish guidelines to implement this section.

L 1975,c. 251, §12, eff. January 1, 1976.

4:24-51. Cooperation with and authorization to receive financial aid from governmental units or private sources

The districts and the committee are authorized to cooperate and enter into agreements with any Federal, State or local agency to carry out the purposes of this act. The districts and the committee are authorized to receive financial assistance from any Federal, State, county or other public or private source for use in carrying out the purposes of this act.

L 1975,c. 251, §13, eff. January 1, 1976.

4:24-52. State aid

The committee is authorized to make grants of State aid to districts and to municipalities to carry out the purposes of this act.

L 1975,c. 251, §14, eff. January 1, 1976.

4:24-53. Violations, injunction; penalty; enforcement

If any person violates any of the provisions of this act, any standard promulgated pursuant to the provisions of this act, or fails to comply with the provisions of a certified plan, the municipality or the district may institute a civil action in the Superior Court for injunctive relief to prohibit and prevent such violation or violations and said court may proceed in a summary manner. Any person who violates any of the provisions of this act, any standard promulgated

pursuant to this act or fails to comply with the provisions of a certified plan shall be liable to a penalty of not less than \$25 nor more than \$3,000 to be collected in a summary proceeding pursuant to the Penalty Enforcement Law (N.J.S. 2A:58-1 et seq.). The Superior Court, County Court, county district court and municipal court shall have jurisdiction to enforce said Penalty Enforcement Law. If the violation is of a continuing nature, each day during which continues shall constitute an additional separate and distinct offense.

L 1975,c. 251, §15, eff. January 1, 1976.

4:24-54. Liberal construction

This act shall be liberally construed to effectuate the purpose and intent thereof.

L 1975,c. 251, §16, eff. January 1, 1976.

4:24-55. Severability

If any provision of this act or the application thereof to any person or circumstances is held invalid, the remainder of the act and the application of such provision to persons or circumstances other than those to which it is held invalid, shall not be affected thereby.

L 1975,c. 251, §17, eff. January 1, 1976.

CHAPTER 113

AN ACT concerning soil restoration measures and amending and supplementing P.L.1975,

c.251.

BE IT ENACTED by the Senate and General Assembly of the State of New Jersey:

1. Section 3 of P.L.1975, c.251 (C.4:24-41) is amended to read as follows:

C.4:24-41 Definitions.

3. For the purposes of this act, unless the context clearly indicates a different meaning:

a. "Application for development" means a proposed subdivision of land, site plan, conditional use zoning variance, planned unit development or construction permit.

b. "Certification" means (1) a written endorsement of a plan for soil erosion and sediment control by the local Soil Conservation District which indicates that the plan meets the standards promulgated by the State Soil Conservation Committee pursuant to this act, (2) that the time allotted in section 7 of this act has expired without action by the district or (3) a written endorsement of a plan filed by the State Department of Transportation with the district.

c. "District" means a Soil Conservation District organized pursuant to chapter 24 of Title 4 of the Revised Statutes.

d. "Disturbance" means any activity involving the clearing, excavating, storing, grading, filling or transporting of soil or any other activity which causes soil to be exposed to the danger of erosion, or compaction of soil which degrades soil so as to make it less conducive to vegetative stabilization.

e. "Erosion" means the detachment and movement of soil or rock fragments by water, wind, ice and gravity.

f. "Plan" means a scheme which indicates land treatment measures, including a schedule of the timing for their installation, to minimize soil erosion and sedimentation, and which specifies the soil restoration measures, consistent with the standards established by the committee pursuant to section 2 of P.L.2010, c.113 (C.4:24-42.1).

g. "Project" means any disturbance of more than 5,000 square feet of the surface area of land (1) for the accommodation of construction for which the State Uniform Construction Code would require a construction permit, except that the construction of a single-family dwelling unit shall not be deemed a "project" under this act unless such unit is part of a

proposed subdivision, site plan, conditional use, zoning variance, planned development or construction permit application involving two or more such single-family dwelling units, (2) for the demolition of one or more structures, (3) for the construction of a parking lot, (4) for the construction of a public facility, (5) for the operation of any mining or quarrying activity, or (6) for the clearing or grading of any land for other than agricultural or horticultural purposes.

h. "Sediment" means solid material, mineral or organic, that is in suspension, is being transported, or has been moved from its site of origin by air, water or gravity as a product of erosion.

i. "Soil" means all unconsolidated mineral and organic material of any origin.

j. "Standards" means the standards promulgated by the committee pursuant to this act.

k. "Committee" means the State Soil Conservation Committee in the Department of Agriculture established pursuant to R.S.4:24-3.

P.L.2010, CHAPTER 113

2

l. "Public facility" means any building; pipeline; highway; electricity, telephone or other transmission line; or any other structure to be constructed by a public utility, municipality, county or the State or any agency or instrumentality thereof.

m. "Soil restoration measures" means those measures taken to ensure, to the maximum extent possible, cost-effective restoration of the optimal physical, chemical, and biological functions for specific soil types and the intended land use.

C.4:24-42.1 Adoption of standards.

2. The committee shall, within one year after the date of enactment of P.L.2010, c.113 (C.4:24-42.1 et al.), and in consultation with the New Jersey Agricultural Experiment Station at Rutgers, the State University, the Secretary of Agriculture and the Commissioner of Environmental Protection, adopt standards pursuant to the "Administrative Procedure Act," P.L.1968, c.410 (C.52:14B-1 et seq.), which shall modify the existing soil erosion and sediment control standards to include soil restoration measures.

3. This act shall take effect on the first day of the 13th month after the date of enactment.

Approved January 5, 2011.

AGRICULTURE
STATE SOIL CONSERVATION COMMITTEE
Soil Erosion and Sediment Control Act Rules

Adopted Rules: N.J.A.C. 2:90-1

Effective Date: February 20, 2014

Expiration Date: December 8, 2017

SUBCHAPTER 1. SOIL EROSION AND SEDIMENT CONTROL ON LAND DISTURBANCE
ACTIVITIES

2:90-1.1 Purpose and scope

(a) The rules in this subchapter are to implement P.L. 1975, c.251, N.J.S.A. 4:24-39 et seq. (hereinafter referred to as “the act”), to secure timely decisions by the soil conservation districts on application for development as defined therein, to assure adequate public notice of procedures thereunder to provide for inspection, compliance and enforcement and to continue effective administration of the law. The rules in this subchapter clarify the long standing provisions of the act prescribing the authorities, roles and responsibilities related to implementation of the act for the State Soil Conservation Committee and soil conservation districts. Such authorities, roles and responsibilities include, but are not limited to, the following:

1. For the State Soil Conservation Committee:
 - i. Develop and promulgate rules and technical and administrative standards;
 - ii. Provide program oversight and training, on its own motion or upon request;
 - iii. Conduct appeals from district decisions;
 - iv. Conduct investigations;
 - v. Provide technical assistance;
 - vi. Institute policies and procedures and guidance;
 - vii. Conduct studies;
 - viii. Provide State aid to districts;
 - ix. Approve district fee schedules;
 - x. Discontinue municipal ordinances addressing soil erosion and sediment control;
 - xi. Provide program related interpretative assistance; and
 - xii. Enter into agreements with public agencies; and
2. For soil conservation districts:
 - i. Make determinations and apply the requirements or grant exemption from the act;
 - ii. Review and certify or deny certification of plans;
 - ii. Perform inspections and take enforcement actions, including violation notices, stop construction orders and seek court remedies or fines for violations;

- iv. Issue or withhold reports of compliance, conditional reports of compliance, or final reports of compliance;
- v. Coordinate with municipalities, counties, State and Federal agencies and instrumentalities thereof;
- vi. Conduct appeals from aggrieved parties;
- vii. Adopt or modify a fee schedule and assess fees;
- viii. Monitor the performance of municipalities implementing erosion control ordinances and recommend discontinuance of municipal ordinances when such performance is unsatisfactory; and
- ix. Enter into agreements with public agencies.

2:90-1.2 Definitions

All definitions in P.L. 1975, c. 251 are incorporated into the rules of this subchapter. The following words and terms, when used in this subchapter, shall have the following meanings, unless the context clearly indicates otherwise.

“Act” means the Soil Erosion and Sediment Control Act of 1975, N.J.S.A. 4:24-39 et seq.

“Appeal” means a request for a review of district action.

“Agriculture and horticulture” means the utilization of land for the production of food, fiber, animals and related activities customary to agricultural and horticultural production and operations.

“Certified plan” means a plan and any revisions thereto reviewed and approved by the district or exempt municipality as conforming to the standards promulgated by the Committee.

“Committee” means the State Soil Conservation Committee.

“Complete application” means an application and all required items as set forth in N.J.A.C. 2:90-1.4 for soil erosion and sediment control plan certification and that are administratively and technically sufficient for district or exempt municipality certification.

“Conservation plan” means a site specific plan which prescribes needed land treatment and related conservation and natural resource management measures deemed by the district to be practical and reasonable for the conservation and protection of agricultural or horticultural productivity and the control and prevention of nonpoint source pollution. Such plan is designed in accordance with the United States Department of Agriculture, June 1, 2005 Field Office Technical Guide, incorporated herein by reference, as amended and supplemented. To obtain a copy of the Field Office Technical Guide, see N.J.A.C. 2:90-1.8(b).

“Demolition” means the demolition of one or more structures including the disturbance of all land area necessary to accomplish the work.

“Exempt municipality” means any municipality that has secured soil erosion and sediment control ordinance approval for implementing N.J.S.A. 4:24-43 through 47 from the Committee prior to May 31, 1978.

“Hearing body” means the State Soil Conservation Committee.

“Major revision” means modifications to the soil erosion and sediment control plan which require the district to reevaluate the adequacy of erosion controls for the project and compare the plan to the standards.

“Minor revision” means modifications which require minimal examination of the submittal and do not impact the integrity of the previously certified soil erosion control measures as determined by the district.

“Sequence of construction” or **“sequence”** means a site specific chronology of proposed erosion

control plan components including temporary and permanent soil erosion and sediment control measures, integrated with site development related land disturbances that minimizes erosion and sedimentation.

“**Withdrawn plan**” means a plan for soil erosion and sediment control which the applicant or their agent has rescinded from further action by the district.

2:90-1.3 Standards for Soil Erosion and Sediment Control

- (a) The State Soil Conservation Committee adopts and hereby incorporates into the rules of this subchapter by reference as standards for soil erosion and sediment control those standards published in the "Standards for Soil Erosion and Sediment Control in New Jersey" and identified as revised on July 11, 2011 as the technical basis for local soil conservation district certification of soil erosion and sediment control plans. Specifically, these standards include the following:

1. Vegetative Standards:

Acid Soil Management.....	1-1
Revised July 11, 2011	
Dune Stabilization.....	2-1
Revised July 11, 2011	
Maintaining Vegetation	3-1
Revised July 11, 2011	
Permanent Vegetative Cover for Soil Stabilization.....	4-1
Revised April 8, 2013	
Stabilization with Mulch Only.....	5-1
Revised July 11, 2011	
Stabilization with Sod.....	6-1
Revised July 11, 2011	
Temporary Vegetative Cover for Soil Stabilization.....	7-1
Revised April 8, 2013	
Topsoiling.....	8-1
Revised April 12, 1999	
Tree Protection During Construction.....	9-1
Revised July 11, 2011	
Trees, Shrubs and Vines.....	10-1
Revised July 11, 2011	

2. Engineering Standards

Channel Stabilization.....	11-1
Revised July 11, 2011	
Conduit Outlet Protection.....	12-1
Revised July 11, 2011	
Detention Structures.....	13-1
Revised July 11, 2011	
Dewatering.....	14-1
Revised July 11, 2011	
Diversions.....	15-1

Revised July 11, 2011	
Dust Control.....	16-1
Revised July 11, 2011	
Grade Stabilization Structure.....	17-1
Revised July 11, 2011	
Grassed Waterway.....	18-1
Revised July 11, 2011	
Land Grading.....	19-1
Revised April 12, 1999	
Lined Waterway.....	20-1
Revised July 11, 2011	
Offsite Stability Analysis.....	21-1
Revised July 11, 2011	
Riprap.....	22-1
Revised July 11, 2011	
Sediment Barrier.....	23-1
Revised July 11, 2011	
Sediment Basin.....	24-1
Revised July 11, 2011	
Slope Protection Structures.....	25-1
Revised July 11, 2011	
Soil Bioengineering	26-1
Revised July 11, 2011	
Stabilized Construction Access.....	27-1
Revised July 11, 2011	
Storm Sewer Inlet Protection.....	28-1
Revised July 11, 2011	
Stream Crossing.....	29-1
Revised July 11, 2011	
Subsurface Drainage.....	30-1
Revised July 11, 2011	
Traffic Control.....	31-1
Revised July 11, 2011	
Turbidity Barrier.....	32-1
Revised July 11, 2011	

3. Copies of the Standards may be obtained by contacting the State Soil Conservation Committee at 609-292-5540, www.state.nj.us/agriculture, or any of the soil conservation districts as follows:

- i. Bergen County Soil Conservation District;
- ii. Burlington County Soil Conservation District;
- iii. Camden County Soil Conservation District;
- iv. Cape-Atlantic Soil Conservation District;
- v. Cumberland-Salem Soil Conservation District (Cumberland and Salem Counties);
- vi. Freehold Soil Conservation District;

- vii. Gloucester County Soil Conservation District;
- viii. Hudson, Essex and Passaic Soil Conservation District;
- ix. Hunterdon County Soil Conservation District;
- x. Mercer County Soil Conservation District;
- xi. Morris County Soil Conservation District;
- xii. Ocean County Soil Conservation District;
- xiii. Somerset-Union Soil Conservation District;
- xiv. Sussex County Soil Conservation District; and
- xv. Warren County Soil Conservation District.

- (b) Where it can be satisfactorily demonstrated by the applicant that unique or innovative control measures or procedures not specified in this chapter may be applicable to specific sites, such measures may be proposed for consideration and utilized subject to approval by the soil conservation district and the State Soil Conservation Committee. To secure such approval, a written request shall be sent to the soil conservation district and State Soil Conservation Committee describing the unique or innovative control measure or procedure and its proposed function or use on the project. Such approval may be granted only where it is determined that strict application of the standards are herein specified will not result in the most practical and effective control of soil erosion, sedimentation and stormwater damage.
- (c) The location, address, and telephone and number of the local soil conservation district may be obtained from the State Soil Conservation Committee, PO Box 330, Trenton, New Jersey 08625-0330. 609-292-5540.

2:90-1.4 Application

- (a) Application for soil erosion and sediment control plan certification shall be made to the local district utilizing standard application forms adopted by the Committee. Such application shall indicate the information required to make a decision on certification of plans. Application forms are available at locations listed at N.J.A.C. 2:90-1.3.
- (b) Applications for certifications of soil erosion and sediment control plans shall include the following items:
 - 1. One copy of the complete subdivision, site plan or construction permit application, including key map as submitted to the municipality (architectural drawings, plans and specifications for buildings not required) which includes the following:
 - i. The location of present and proposed drains and culverts with their discharge capacities and velocities and supporting computations and identification of conditions below outlets;
 - ii. A delineation of any area subject to flooding from the 100-year storm in compliance with the Flood Hazard Area Control Act, N.J.S.A. 58:16A-50 et seq., or applicable municipal zoning;

- iii. A delineation of streams and wetlands pursuant to N.J.S.A. 13:9A-1 et seq. and 13:9B-1 et seq., and other significant natural features within the project area;
 - iv. The soils and other natural resource information used (delineation of the project site on soil map is desirable);
 - v. The land cover and use of area adjacent to the land disturbance; and
 - vi. All hydraulic and hydrologic data describing existing and proposed watershed conditions and a completed copy of the Hydraulic and Hydrologic Data Base Summary Form SSCC 251 HDF1. Where computer simulation models (such as HEC-HMS, HEC-RAS, TR-55, or other similar models) are used to analyze or predict hydrologic or stream flow responses to project development, a copy of such input files shall be submitted to the district. The Data Base Summary Forms and information regarding these computer programs are available at the locations listed at N.J.A.C. 2:90 1.3;
2. Up to four copies of the soil erosion and sediment control plan at the same scale as the site plan submitted to the municipality nor other land use approval agency which includes the following information detailed at the plat:
- i. The proposed sequence of development including duration of each phase in the sequence;
 - ii. A site grading plan delineating land areas to be disturbed including proposed cut and fill areas together with existing and proposed profiles of these areas;
 - iii. Contours at a two foot interval, showing present and proposed ground elevation;
 - iv. The locations of all streams and existing and proposed drains and culverts;
 - v. A stability analysis below all points of stormwater discharge which demonstrates that a stable condition will exist or there will be no degradation of the existing condition;
 - vi. The location and detail of all proposed erosion and sediment control structures including profiles, cross sections, appropriate notes, and supporting computations;
 - vii. The location and detail of all proposed nonstructural methods of soil stabilization including types and rates of lime, fertilizer, seed and mulch to be applied;
 - viii. Erosion control measures for non-growing season stabilization of exposed areas where the establishment of vegetation is planned as the final control measure;

- ix. For residential development, erosion control measures which apply to dwelling construction on individual lots with notation on the final plat that requirement for installation of such control measures shall apply to subsequent owners if title is conveyed; and
 - x. Plans for maintenance of permanent soil erosion and sediment control measures and facilities during and after construction, which include the designation of persons or entity responsible for such maintenance;
3. An Ownership Disclosure Affidavit Form to determine potential conflicts of interest between the applicant and soil conservation district supervisor or staff.
 - i. A corporation must indicate its registered agent and officers.
 - ii. A corporation, partnership, or limited liability corporation (LLC) shall list the names and addresses of all stockholders or individual partners owning at least 10 percent of its stock of any class, or at least 10 percent of the interest in the partnership.
 - iii. Any transfer of ownership of more than 10 percent must be disclosed to the district;
 4. Appropriate fees as adopted by the individual district and approved by the Committee (see N.J.A.C. 2:90-1.12); and
 5. Additional information as may be required by the district depending upon the scope, topography and complexity of the project.
- (c) The applicant shall certify and agree that the applicant shall:
1. Certify that all soil erosion and sediment control measures are designed in accordance with current Standards for Soil Erosion and Sediment Control in New Jersey as promulgated by the Committee and found at N.J.A.C. 2:90-1.3 and will be installed in accordance with the plan as approved by the district;
 2. Acknowledge that structural measures contained in the soil erosion and sediment control plan are reviewed for adequacy to reduce offsite soil erosion and sedimentation and not for adequacy of structural design;
 3. Retain full responsibility for any damages which may result from any construction activity notwithstanding district certification of the soil erosion and sediment control plan;
 4. Require that all engineering related items of the soil erosion and sediment control plan be prepared by or under the direction of and be sealed by a professional engineer or architect licensed in the State of New Jersey in

accordance with N.J.A.C. 13:27-6;

5. Assure that any conveyance of the project or portion thereof is conditioned upon transfer of full responsibility for compliance with the certified plan to any subsequent owners;
 6. Maintain a copy of the certified plan on the project site during construction;
 7. Allow district agents to go upon project lands for inspection; and
 8. Notify the district in writing at least 48 hours in advance of any land disturbance activity and upon completion of the project.
- (d) If the person submitting the application is not the project owner, a notarized authorization by the owner or authorized corporate officer must be submitted with the application. For public agency projects, such authorization shall be made by the principal executive officer or elected official of the agency.
- (e) All requests for determination that the act does not apply to land disturbance activity shall be submitted to the district by the owner or their authorized representative. Non-applicability requests shall be in writing and include a plot or site plan depicting all proposed areas of disturbance and a resolution from the municipality or other suitable documentation indicating the date the lot was created. Hardship exemptions or waivers shall not be authorized. The act does not apply to the following activities:
1. Land disturbance activities 5,000 square feet or less; and
 2. Single-family dwelling lots not regulated under N.J.A.C. 2:90- 1.5.
- (f) Any land disturbance activity to which the act was initially determined not to apply but which subsequently falls within the definition of project, as defined in N.J.S.A. 4:24-41g, shall be subject to the rules of this subchapter.
- (g) Any application for development for a project that was approved by the State, any county, municipality, or any instrumentality thereof, without the condition that the application for development comply with the act pursuant to N.J.S.A. 4:24-43 and this subchapter, shall not be relieved of the obligation to conform to the act and this subchapter. A successor in title shall be subject to this subchapter.

2:90-1.5 Single-family dwelling unit lots

- (a) An application for a construction permit for any single-family dwelling unit, on any lot that has arisen from a subdivision approved after January 1, 1976 comprising two or more contiguous or non-contiguous single-family dwelling lots, the construction of which would disturb greater than 5,000 square feet, including associated offsite improvements, is subject to the act, and the applicant/owner shall secure certification of a soil erosion and sediment control plan. The act shall also apply if any lots in the subdivision are

conveyed to separate owners or if construction is by the same or a separate applicant, owner, builder or contractor.

- (b) The concurrent construction of two or more single-family dwelling units, by the same applicant, owner, builder or general contractor on lots that were part of a preexisting subdivision approved prior to January 1, 1976, shall be subject to the act and this subchapter provided that the proposed cumulative land disturbance, including associated offsite improvements, is greater than 5,000 square feet.

2:90-1.6 Mining and quarrying activities

Certification of a soil erosion and sediment control plan shall be required for the operation of all mining or quarrying activities regardless of proposed or actual related agricultural or horticultural use. Mining or quarrying activities shall include the extraction and removal of soil and/or sediment, as defined in N.J.S.A. 4:24-41, from the proposed site.

2:90-1.7 Demolition activities

Any demolition activity of one or more structures and any associated new disturbance activity involving more than 5,000 square feet in size including the construction of one single-family dwelling or other project shall obtain soil erosion and sediment control plan certification.

2:90-1.8 Clearing or grading of land

- (a) Except as provided in (b) and (c) below, a person proposing to engage in or who is engaging in clearing or grading of more than 5,000 square feet of land shall be subject to the act unless such land disturbance is for agricultural or horticultural purposes. To demonstrate to the district that such activity is related to proposed agricultural or horticultural activities, the owner shall provide proof that the land is enrolled in a farmland preservation program, eligible for farmland assessment, qualifies for right-to-farm protections, or possesses a farm conservation plan or forest management plan, timber harvest sale contract or other proofs deemed appropriate by the district. Anyone seeking to provide a farm conservation plan as proof of agricultural or horticultural use must waive confidentiality under the Federal Freedom of Information Act. The district shall determine if the proofs demonstrate an agricultural or horticultural activity or is subject to the act and this subchapter.
- (b) Certification of a soil erosion and sediment control plan shall be required for the construction of agricultural structures, involving the disturbance of greater than 5,000 square feet of land unless the disturbance is incorporated into a farm conservation plan approved by the district as conforming to the United States Department of Agriculture, June 1, 2005 Field Office Technical Guide, which is hereby adopted and incorporated by reference, as amended and supplemented.

1. Copies of the New Jersey Field Office Technical Guide are available from the NRCS Field Offices and the State Office at 220 Davidson Ave., 4th Floor, Somerset, NJ 088873.

2. An electronic copy of the New Jersey Field Office Technical Guide is available at <http://www.nrcs.usda.gov/technical/efotg/>.
 3. A copy of this document is on file in the NJDA Office of the Director, Division of Agricultural and Natural Resources, Health and Agriculture Building, Market and Warren Streets, Trenton, NJ 08625.
- (c) Disturbances on agricultural land greater than 5,000 square feet in size other than for agricultural or horticultural purposes, may be subject to the act and this subchapter or may be incorporated into the farm conservation plan when so determined by the district.

2:90-1.9 Procedure

- (a) The district shall carry out the provisions of N.J.S.A. 4:24-43 through 47.
- (b) No project shall be undertaken by any person, partnership, corporation, or limited liability corporation (LLC) or other private or public agency unless the applicant has submitted to the district with local jurisdiction a plan for soil erosion and sediment control for such project, and the plan has been certified by the district as conforming to the standards promulgated by the New Jersey State Soil Conservation Committee. The plan shall provide for the control of soil erosion and sedimentation and utilize the standards adopted by the Committee.
- (c) Approval by a municipality officer or agency for an application for development for any project shall be conditioned upon certification by the district for a plan for soil erosion and sediment control.
- (d) The district shall review all soil erosion and sediment control plans submitted with a complete application and provide that the applicant or their agent with a written notice indicating that:
 1. The plan was certified;
 2. The plan was certified subject to the attached conditions; or
 3. The plan was denied certification with the reasons for the denial stated.
- (e) The district shall include in the notice of certification or on the certified plan the following clause: "This certification is limited to the controls specified in this plan. It is not authorization to engage in the proposed land use unless such use has been previously approved by the municipality, county, State agency or other controlling agency."
- (f) The district shall furnish the municipal planning board, municipal construction official, and municipal engineer, or other responsible official or entity in the case of a county, State or other agency, a copy of the certification or denial including all conditions and statements.
- (g) The district shall grant or deny certification within 30 days from submission of a

- complete application. The district may be granted an additional 30-day review period through mutual written agreement with the applicant. Failure of the district to grant or deny certification within such period or such extension thereof shall constitute certification. When the applicant fails to respond to two or more written requests by the district for additional information, the application may be denied. If the district denies an application for soil erosion and sediment control plan certification, the applicant may resubmit the plan at any future time for review and certification.
- (h) The applicant may withdraw an application or a certified plan by written request to the district. The applicant may subsequently resubmit the plan for certification.
 - (i) District certification of a soil erosion and sediment control plan for any project shall be valid only for the duration of the initial project approval granted by the municipality or other land use approval agency but in no case shall exceed three and one-half years. All such municipal or other agency renewals of the project will require resubmission of the project plan and recertification approval by the district. Certification of the plan is conferred upon the project and may be transferred or conveyed.
 - (j) The current project owner shall notify the district in writing if there is a change of ownership during implementation of the plan.
 - (k) By formal action, a district may delegate jurisdiction over a project to another district. An applicant proposing a project that requires certification by more than one district shall secure certification from each respective district unless full jurisdiction is transferred to one district.
 - (l) The sequence of construction shall be an integral component of the certified plan and shall be followed by the applicant or their agent during all phases of the project. The sequence shall incorporate the installation of temporary and permanent controls, and shall include, but not be limited to, clearing and grading, cuts and fills, temporary diversions, sediment basins, tracking controls, temporary and permanent stabilization and dust control. The sequence of construction may be revised and shall be resubmitted to the district for approval during construction to address site concerns.
 - (m) At its discretion, the district may require an interim clearing and grading plan on a project for critical area stabilization during construction due to the presence of erodible soils, slopes or water quality concerns for mitigating existing, emerging or anticipated erosion hazards.

2:90-1.10 Revisions to the certified plan

- (a) A district may require a new submission of the plan, supporting documentation, application and fee when a major revision is made. The district may require submission of a revised plan, supporting documentation and a fee where minor revisions are needed.
- (b) Revisions to the certified plan shall be submitted to the district for reevaluation and certification prior to implementation of the change. Such changes shall be in accordance

with the standards in effect on the date that revisions to the plan are being submitted to the district.

- (c) Revisions to a plan required during construction shall be submitted to the district for certification. No report of compliance or conditional report of compliance shall be issued if the district determines that a revision to the plan is required.

2:90-1.11 Exempt municipality ordinances and implementation

- (a) Adoption by the municipality of soil erosion and sediment control ordinances for approval by the Committee must have been completed by May 31, 1978, in order to qualify for an exemption from N.J.S.A. 4:24-43 through 47. Such exempt municipalities shall enforce the provisions of the ordinance in conformance with district policies and procedures for consistency between municipal and district erosion control programs Statewide.
- (b) Exempt municipal ordinances may specifically require municipal certification of demolition, parking lot construction, land clearing or grading or mining and quarrying activities. Where such projects are not encompassed in the ordinance, the municipality shall not exercise jurisdiction until the ordinance is amended and approved by the Committee. No exempt municipality shall exercise jurisdiction over plan certification on any county or a State project; or where municipal regulation of a municipal project would constitute a conflict of interest or the appearance of a conflict of interest. In all such cases, such projects shall be referred to the district for certification and enforcement.
- (c) No exempt municipality or any other municipality shall implement a soil erosion and sediment control ordinance or provision that is more restrictive than the definition of project in the act. No exempt municipality may grant a waiver of the requirements or grant an exemption for a project as defined in the act or rules promulgated thereto.
- (d) Soil erosion and sediment control ordinances adopted by exempt municipalities may provide for the review and certification of plans, inspection and enforcement by the district in accordance with this subchapter. In all such cases, there shall be written contracts with the municipality, the district and the Committee. The district shall utilize its fee schedule for collection of fees from applicants.
- (e) Exempt municipalities implementing ordinances approved by the Committee shall utilize the Committee's standard application form, letter of certification form, reports of compliance form, quarterly report form and Hydraulic and Hydrologic Basin Summary form.
- (f) Exempt municipal officials enforcing the provisions of the ordinance shall be knowledgeable in natural resources management and qualified to review plans and inspect project sites. Municipal staff shall attend Committee approved training courses, no less than once every two years.
- (g) Exempt municipalities implementing ordinances approved by the Committee shall

provide reports to the district and provide information as follows:

1. Verification of municipal certification of the soil erosion and sediment control plan for the Construction General Permit 5G3 for eligible activities: at the end of each business week;
 2. A copy of the Hydraulic and Hydrologic Basin Summary form for all newly certified stormwater basins and stormwater outfalls within 15 days following the end of each calendar-year quarter; and
 3. The following information shall be provided to the local district by March 15 of each year:
 - i. The current soil erosion and sediment control ordinance; and
 - ii. The municipal agent contracts responsible for implementing the erosion control ordinance and training classes attended.
- (h) Failure by any exempt municipality to satisfactorily implement the ordinance as determined by the district or conform with this section, may result in action by the Committee to revoke the ordinance.
- (i) Districts shall annually review for compliance all soil erosion and sediment control ordinances enacted by exempt municipalities within the district. The municipality shall cooperate with the district to demonstrate the manner of municipal implementation of the erosion control ordinances. The district shall inform the committee in writing of the results of this review by April 15 of each year. If at any time during the year, the district determines and so notifies and provides proof to the Committee that any exempt municipality is not enforcing its soil erosion and sediment control ordinance, the Committee shall consider the proofs given and the Committee shall provide written notice to the municipality that it is no longer exempt from N.J.S.A. 4:24-43 through 47. The Committee, at its discretion, may schedule a hearing to review revocation of exempt status.
- (j) Any proposed changes to an exempt municipal ordinance which has received the approval of the committee, and is therefore exempt from N.J.S.A. 4:24-43 through, must be submitted to the Committee for review and approval prior to enactment of the revised ordinance. For the municipality's exempt status to continue, all such changes must be found to be in accordance with the act and approved as such by the Committee. Failure of the municipality to secure written notification of approval will result in discontinuance of municipal exemption from N.J.S.A. 4:24-43 through 47.

2:90-1.12 Fees

- (a) Ordinary fees: Reasonable fees shall be set by the districts based on the costs for providing services. The district shall establish fee categories based on the types and sizes of construction projects and an hourly rate for assessing fees. The fee schedule provisions proposed by each district shall be approved by the committee before it is implemented by

the district. Any person aggrieved on the set fee may appeal to the Committee as outlined in N.J.A.C. 2:90-1.16.

- (b) Extraordinary fees: The district fee schedule may include the assessment of fees for reimbursement of extraordinary expenses resulting from enforcement actions taken. The district may seek reimbursement for litigation expenses including court costs and attorney’s fees from the adverse party as part of a negotiated settlement agreement or where the district prevails in any litigation action.
- (c) Interest income derived from fee reserve balances may be utilized by the district for implementing district education programs for applicants, contractors, municipal officials and the public.
- (d) Fee for certain federal projects: Certain federal project activities that are precluded from making fee payments directly to a district, based on applicable federal and state laws shall remit fees payable to “Treasurer, State of New Jersey” to the local district in which the project is to be undertaken. The fee shall be submitted in conjunction with the plan for soil erosion and sediment control certification. The fee shall be in accordance with the following fee schedule based on the land surface area to be disturbed:

Federal Project Fee Schedule

<u>Disturbance Area*</u>	<u>Review Fee**</u>	<u>Inspection Fee***</u>
1 to 5 acres	\$950	\$325 per acre
6 to 10 acres	\$1,600	\$260 per acre
11 to 25 acres	\$2,300	\$200 per acre
26 to 50 acres	\$3,000	\$180 per acre
51 acres and greater	\$3,500	\$160 per acre

* For projects greater than one (1) acre, partial acres are to be rounded to the nearest whole acre.

**Major revisions to a previously certified plan are subject to ½ the original review fee.

***Reinspection Fee: A fee of \$150 may be assessed (a) when the contractor has failed to provide the district with a 48 hour advance written notice of the start of construction, or (b) when the second or subsequent district inspection was conducted and there was a failure to address the same problem identified in the first written notice of non-compliance issued to the applicant/contractor, or (c) when the contractor requested an inspection for receiving a Report of Compliance and such district inspection was performed, but the site was not in compliance with the certified plan and the Standards. A copy of all written violation notices shall be issued to the contractor with a copy provided to the local controlling federal agency.

2:90-1.13 Enforcement

- (a) Inspection of projects to determine execution in accordance with the certified plan shall be carried out by the district in close coordination with the municipal engineer and building inspector.
- (b) The district shall determine whether or not the provisions of the certified plan and sequence of construction are being followed by the applicant.
- (c) The district shall inform the applicant in writing of observed deviation from the certified plan and request immediate compliance with the plan. Failure of the applicant to adequately correct deficiencies in the time frame set forth in the district letter to the applicant shall result in the issuance of a violation notice. Failure of the applicant to correct the deficiencies in the violation notice may result in the issuance of a stop construction order.
- (d) The district or the municipality may issue a stop-construction order if the applicant fails to take a majority of identified actions to comply with the provisions of the certified plan. The district or municipality may issue a stop-construction order if a person initiates land disturbance prior to securing plan certification or fails to renew plan certification on an active project within 30 days of receiving notice of pending expiration from the district or municipality.
- (e) When a stop-construction order is issued, no further construction activity or any other work may take place on the project except for implementation of erosion controls as required by the district, until such time the project is in compliance with all provisions of the certified plan.

2:90-1.14 Reports of Compliance

- (a) A district having certified a soil erosion and sediment control plan for a project pursuant to N.J.S.A. 4:24-39 et seq. shall issue a written Final Report of Compliance (FROC) in accordance with this section, upon the district's determination that the project is in full and complete compliance with the requirements and provisions of the certified plan such that all permanent measures to control soil erosion and sedimentation are in effect for the entire project.
- (b) A Report of Compliance (ROC) shall be issued when the District determines that a project or portion thereof is in full compliance with the certified plan and the Standards for Soil Erosion and Sediment Control in New Jersey (see N.J.A.C. 2:90-1.3), and that the permanent measures to control soil erosion and sedimentation are in effect for the area encompassed by the ROC.
- (c) A Report of Compliance with Conditions (CRC) shall be issued when the District determines that the project or portion thereof is not yet in full compliance with the certified plan but is in satisfactory compliance to the extent practicable and in accord with the sequence of development and requirements thereof, such that the issuance of a

- temporary and conditional approval is appropriate with such conditions as may be imposed by the District. Satisfactory compliance means temporary measures and appropriate permanent measures for soil erosion and sediment control have been implemented according to the Standards including provisions for stabilization, site work and that no other site specific concerns exists.
- (d) Upon written request from the applicant, the District may issue a ROC or CRC on a lot-by-lot or section-by-section basis for a project when lots or sections are part of the project.
- (e) The district may withhold an ROC, CRC, or FROC for any project that has not secured discharge authorization of the stormwater general permit 5G3 where an NJPDES permit is required for stormwater discharges associated with a construction activity pursuant to N.J.A.C. 7:14A-24.2.
- (f) All fees shall be paid to the district prior to issuance of the ROC, CRC, or FROC.
- (g) A standard Report of Compliance form approved by the State Soil Conservation Committee shall be utilized by the district and shall allow for the district's issuance of a CRC, ROC or FROC. The district shall complete the standard Report of Compliance form in accordance with the requirement set forth in (g) 1 through 4 below.
1. The district shall identify on the standard Report of Compliance form the block and lot, street address (if known), municipal location, the District application number and the date of issuance of the ROC.
 2. The district shall state on the standard Report of Compliance form that the project or applicable portion thereof is in compliance with permanent measures to the extent determined by the district.
 3. In order for the district's issuance of a ROC to be valid and effective, the standard Report of Compliance form shall be signed by an authorized district official, the district chairman or designee, and specify its effective date.
 4. In order for the district's issuance of a CRC to be valid and effective, the district shall comply with the requirements set forth in (g) 1 through 3 above, and shall state in the standard Report of Compliance form all conditions that are to be satisfied to assure compliance with the requirements of the certified plan, as well as the date for completion of such conditions.
- (h) Copies of the ROC, CRC or FROC shall be distributed by the district to the applicant; the municipal construction code official having construction code jurisdiction for the project, if applicable; and/or in the case where a construction permit is not required for a project (such as for mining and land clearing projects among others), the municipal official having jurisdiction over such project, if any.
1. The district may also issue a copy of a ROC or CRC, to such other persons or

entities, as the district deems necessary or appropriate in its discretion. This includes, without limitation, and county, state and Federal agency, or instrumentality thereof, exercising any jurisdiction over the project.

2. In the case where a municipality authorized under N.J.S.A. 4:24-48 is the issuing agent, a copy of all ROC's and CRC's shall be submitted to the local District.
 - (i) No certificate of occupancy (CO) for a building or structure on a project, or any portion thereof, shall be issued by a municipality or any other public agency unless there has been an ROC or FROC issued by the district indicating compliance with the provisions of the certified plan for measures to control soil erosion and sedimentation. The district shall provide the municipality or other public agency with an ROC or FROC in accordance with (h) above.
 - (j) No temporary certificate of occupancy (TCO) for a building or structure on a project, or any portion thereof, shall be issued by a municipality or any other public agency unless a CRC or ROC is issued by the district. The district shall provide the municipality or other public agency with a copy of the CRC, ROC or FROC.
 - (k) During the non-growing season, as defined in the Standards for Soil Erosion and Sediment Control in New Jersey (the Standards), or where seasonal or weather related constraints exist, or where the applicant's scheduling has prevented or delayed final stabilization (for example, completed site work during winter), the District may issue a CRC or ROC in accordance with (k) 1 through 3 below.
 1. Where the applicant has completed temporary stabilization and provided temporary erosion control measures in compliance with the certified soil erosion and sediment control plan, the applicant may request a CRC or ROC from the District. The District may also require the applicant to provide a performance deposit and enter into a performance agreement with the District to assure completion of final stabilization. In such instance, the District, at its option, may issue the CRC or ROC subject to the requirement that final stabilization be completed by the date indicated on the performance agreement such as, by the end of the next growing season, as defined in the Standards or such reasonable time period established by the District.
 2. Upon receipt of the signed performance agreement and cash performance deposit, the District shall deposit the performance deposit into an interest escrow account with interest to accrue to the benefit of the applicant. The applicant shall sign and deliver to the District, any and all forms required by the District or its bank to open and maintain such interest bearing escrow account.
 3. Upon completion of final stabilization by the applicant, the District shall return such performance deposit with interest to the applicant minus the administrative costs assessed by the District pursuant to (i)6 below.
 4. Upon the failure of the applicant to timely or satisfactorily implement the permanent

stabilization in accordance with performance agreement and this section, the District shall provide written notification of such failure to the applicant together with a demand that such failure be fully cured within 10 calendar days of the date of such notification to the District's satisfaction or a later date established by the District.

If after such 10 calendar day period, or agreed-to time frame, such failure is not fully and properly cured to the District's satisfaction the District may utilize the applicant's performance deposit in order to contract for all work necessary or required to cure such failure and to complete all permanent measures in accordance with the performance agreement.

5. The District's rights and remedies pursuant to this subsection are in addition to all of its other rights and remedies under the law including N.J.S.A. 4:24-39 et seq.
 6. The District may charge a fee in connection with the processing and administration of the performance agreement and performance deposit, which shall be listed in the District fee schedule, approved by the Committee.
- (1) Any exempt municipality authorized by the Committee pursuant to N.J.S.A. 4:24-48, and implementing an approved ordinance thereunder shall implement these provisions.

2:90-1.15 Reports

The districts shall submit quarterly reports to the committee giving number of applications, number of certifications, denials and number of reviews and other information as required by the Committee. Reports shall be submitted to the Committee within 15 days after the end of each quarter. A copy shall be retained by the district.

2:90-1.16 Appeal process

- (a) Any person aggrieved by a decision or action of the district shall first submit a written request for reconsideration to the district within 10 working days of the action taken. The district shall convene a meeting and make a determination on the request within 35 calendar days of the request unless additional time is mutually agreed upon by the district and the aggrieved person. All such proceedings shall be memorialized in the district minutes.
- (b) To appeal the determination of the district, the aggrieved person shall subsequently petition the Committee in writing within 10 working days of the determination by the district. The Committee shall schedule a hearing and make a determination within 90 calendar days of the petition for review and notify the appellant pursuant to (c) below unless additional time is mutually agreed upon by the Committee and the aggrieved person. The Committee may appoint and utilize the hearing office procedures of the Department of Agriculture for fact-finding and recommendations to the Committee. The Committee may alternatively pursue an informal resolution of the matter contested. Any person against whom a stop-construction order is issued by any district shall also have the right to appeal directly to the

THIS IS A COURTESY COPY OF THIS ADOPTION. THE OFFICIAL VERSION WILL BE PUBLISHED IN THE JANUARY 20, 2014, NEW JERSEY REGISTER. SHOULD THERE BE ANY DISCREPANCIES BETWEEN THIS TEXT AND THE OFFICIAL VERSION OF THE ADOPTION, THE OFFICIAL VERSION WILL GOVERN.

Committee. Requests for appeal shall be addressed to:

State Soil Conservation Committee
PO Box 330
Trenton, New Jersey 08625

- (c) The Committee shall send a written notice to the appellant of the hearing stating:
 - 1. The hearing application number; and
 - 2. The date, time and place of the hearing.

- (d) The Committee may, on its own motion or at the request of any person aggrieved of any action by the district, review the decision of any soil conservation district and make whatever determinations it deems appropriate in the matter.

- (e) Any party who disagrees with the determination of the Committee may request a hearing pursuant to the Administrative Procedure Act, N.J.S.A. 52:14B-1 and 52:14F-1 et seq.

Chronology of Standards For Soil Erosion And Sediment Control in New Jersey

VEGETATIVE STANDARDS

Acid Soils Management: Adopted July 1999, July 2011

Dune Stabilization: Adopted June 1972, Revised January 1974, September 1979, April 1987, July 1999, July 2011

Maintaining Vegetation: Adopted June 1972, July 1999, July 2011

Permanent Vegetative Cover for Soil Stabilization: Adopted June 1972, Revised January 1974, September 1979, April 1987, July 1999, April 2013

Stabilization With Mulch Only: Adopted June 1972, Revised January 1974, September 1979, July 1999, July 2011

Stabilization with Sod: Adopted June 1972, Revised January 1974, September 1979, July 1999, July 2011

Temporary Vegetative Cover For Soil Stabilization: Adopted June 1972, Revised January 1974, September 1979, April 1987, April 2013

Topsoiling: Adopted June 1972, Revised September 1979, July 1999,

Tree Protection During Construction: Adopted January 1974, Revised April 1987, July 1999, July 2011

Trees, Shrubs and Vines: Adopted January 1974, Revised July 1999, July 2011

ENGINEERING STANDARDS

Channel Stabilization: Adopted June 1972, Revised January 1974, September 1979, April 1987, July 1999, July 2011

Conduit Outlet Protection: Adopted September 1979, Correction November 1980, Revised April 1987, July 1999, July 2011

Detention Structures Formerly: Basin, Formerly Floodwater Retarding Structure. Revised April 1987, July 1999, July 2011

Dewatering: Adopted July 1999, Revised July 2011

Diversions: Adopted June 1972, Revised September 1979, April 1987, July 1999, July 2011

Dust Control: Adopted January 1974, Revised September 1979, April 1987, July 1999

Floodwater Retarding Structures: Adopted June 1972, Revised January 1974, July 1999, Changed to Detention Basin and Revised April 1987, July 1999

Grade Stabilization Structure: Adopted April 1987, July 1999, July 2011

Grassed Waterway: Adopted June 1972, Revised September 1979, April 1987, July 1999, July 2011

Land Grading: Adopted June 1972, Revised January 1974, April 1987, July 1999

Lined Waterway: Adopted September 1979, Revised April 1987, July 1999, July 2011

Off-Site Stability Analysis: Adopted July 1999, July 2011

Parking Lot Storage: Adopted April 1987, July 1999, Combined with Detention Structures, July 2011

Riprap: Adopted September 1979, Revised April 1987, July 1999, July 2011

Rooftop Storage: Adopted April 1987, July 1999, Combined with Detention Structures, July 2011

Sediment Barrier: Adopted September 1979, Revised April 1987, July 1999, July 2011
Sediment Basin: Adopted June 1972, Revised January 1974, September 1979, April 1987, July 1999, July 2011
Slope Protection Structures: Adopted June 1972, Revised January 1974, April 1987, July 1999, July 2011
Soil Bioengineering: Adopted July 1999, Revised July 2011
Stabilized Construction Entrance: Adopted September 1979, Revised April 1987, July 1999, July 2011
Storm Sewer Inlet Protection: Adopted September 1979, Revised April 1987, July 1999, July 2011
Stream Crossing: Adopted July 1999, July 2011
Traffic Control: Adopted January 1974, Revised April 1987, July 1999, July 2011
Turbidity Barrier: Adopted July 1999, July 2011
Underground Tanks: Adopted April 1987, July 1999, combined with Detention Structures , July 2011

RUNOFF TREATMENT STANDARDS

(merged into NJDEP Stormwater Best Management Practices Manual 2004)

Preface to the Runoff Treatment Standards: Adopted July 1999, Rescinded 2004
Dry Wells: Adopted July 1999, Rescinded 2004
Extended Detention Basin: Adopted July 1999, Rescinded 2004
Infiltration Structures: Adopted July 1999, Rescinded 2004
On Line Water Quality Storm Sewer Catch Basin: Adopted July 1999, Rescinded 2004
Sand Filters: Adopted July 1999, Rescinded 2004
Vegetative Filter Strips: Adopted July 1999, Rescinded 2004
Wet Ponds: Adopted July 1999, Rescinded 2004

APPENDIX A

The Universal Soil Loss Equation: Published June 1972, Revised September 1979, April 1987 , July 1999
Requirements for a Soil Erosion and Sediment Control Plan: Published June 1972, Revised 1976, November 1982, April 1987, July 1999, July 2011
Guide for Construction Specifications: Published June 1972, Revised July 1980, November 1982, April 1987, July 1999
Maintenance of Structural Measures: Published June 1972, Revised April 1987, July 1999
Guide for Installing Soil Stabilization Matting: Published June 1972, July 1999
Diversion and Grassed Waterway Design Procedure: Published July 1980, Revised April 1987, July 1999
Sediment Basin Design Procedure: Published July 1980, July 1999
Channel Stability Analysis Procedure: Published July 1980, Revised April 1987 Modified Rational Method: Published April 1987, July 1999

Structural Guidelines for Detention Basin. Published April 1987 REFERENCES: Published June 1972, Revised January 1974, July 19676, July 1980, April 1987 , July 1999, Karst Remediation Measures separated as a stand-alone document July 2011

APPENDIX B

Example for Seed Specifications Published June 1972, Revised July 1999
Grass and Legume Planting Guide: Published June 1972, Revised July 1999

APPENDIX C

Soil Erosion and Sediment Control Act Effective January 1, 1976, Amended October 18, 1977, February 27, 1980, January 5, 2011

New Jersey Administrative Code 2:90-1.1 et seq: Effective January 1, 1976, Amended January 5, 1978, July 3, 1980, Readopted June 24, 1985, Amended April 6, 1987, Revised July 1999, January 2006, June 2008, February 2014

Chronology of Standards for Soil Erosion and Sediment Control in New Jersey: Published July 1980, Revised November 1982, April 1987, July 1999, July 2011

APPENDIX D

Glossary: Published June 1972, Revised July 1980, April 1987, July 1999

APPENDIX E

Directory Soil Conservation Districts in New Jersey: Published June 1972, Revised January 1974, July 1976, July 1980, November 1982, April 1987, July 1999, July 2011

APPENDIX K

Investigation, Design and Remedial Measures for Areas Underlain by Cavernous Limestone
Revised as a stand-alone appendix July 2011

APPENDIX D
G L O S S A R Y

Acre-feet - An engineering term used to denote a volume 1 acre in area and 1 foot in depth.

Acid Soil - (high acid producing) Soil containing iron sulfide material, which on exposure to air, results in the production of sulfuric acid and is accompanied by pH levels falling to 3 or below. Treatment with limestone only provides a short term buffering effect with burial at a minimum of 12" of non acid producing soil is the only effective treatment .

Aggrade - The alteration of a channel caused by the deposition of sediment.

Allowable velocity - the velocity of flowing water within a defined channel or landform which will not scour and transport surface soil. Non-scouring velocities differ with different soil types.

Anti-seep Collar - A device constructed around a pipe or other conduit placed through a dam, dike, or levee for the purpose of reducing seepage losses and piping failures.

Anti-vortex Device - A facility placed at the entrance to a pipe conduit structure such as a drop inlet spillway or hood inlet spillway to prevent air from entering the structure when the pipe is flowing **full**.

Barrel - See conduit.

Borrow Area - A source of earth fill materials used in the construction of embankments or other earth fill structures.

Bottomlands - A term often used to define lowlands adjacent to streams (flood plains in rural areas).

Box Inlet Drop Spillway - A form of principal spillway.

Cabled Concrete (articulated concrete block)- Blocks of concrete (typically 1' x 1') strung together with a non-corroding metal cable. Used for lining of waterways, shorelines etc.

Cantilever Outlet - A discharge pipe extending beyond its support.

Cascades or Bedrock - Section of stream without pools, consisting primarily of bedrock with little rubble, gravel, or other such material present. Current usually more swift than in riffles.

Channel - A natural stream that conveys water; a depth or channel excavated for the flow of water.

Chute Spillway - A form of principal spillway.

Conduit - A closed facility used for the conveyance of water.

Cool Season Mixture - Grasses or legumes which maximize growth at temperatures below 85 degrees F.

Cover Crop - A crop grown primarily for the purpose of protecting soil between periods of permanent vegetative cover.

Cradle - A device usually concrete, used to support a pipe conduit or barrel.

Crimper - (mulch anchoring coultter tool) A tractor drawn implement, somewhat like a disc harrow designed to push or cut some broadcast, long fiber mulch, such a straw, into the soil 3 to 4 inches so as to anchor it to the soil.

Cutoff Trench - A long, narrow excavation constructed along the center line of a dam, dike, levee or embankment

and filled with relatively impervious material intended to reduce seepage of water through porous strata.

Degrade - The alteration of a channel caused by the erosion and scour of the channel bottom.

Design Highwater - The elevation of the water surface as determined by the flow conditions of the design floods.

Design Life - The period of time for which a facility is expected to perform its intended function.

Diversion - A channel with or without a supporting ridge on the lower side constructed across or at the bottom of a slope for the purpose of intercepting surface runoff.

Dune - A mound or ridge of sand which has been formed by wave or wind action.

Embankment - A man-made deposit of soil, rock or other materials used to form an impoundment.

Emergency Spillway - A vegetated earth channel used to safely convey flood discharges in excess of the capacity of the principal spillway.

Energy Dissipater - A device used to reduce the energy of flowing water.

Erosion - Detachment and movement of soil or rock fragments by water, wind, ice and gravity.

Field Capacity - The amount of water retained in a soil after it has been saturated and has drained freely. It is usually expressed as a percentage of the oven-dry weight of the soil. Also called field moisture capacity.

Filter Blanket - A layer of sand, gravel, or synthetic fabric designed to prevent the movement of fine grained soils.

Filter Strip - A strip of planted or indigenous vegetation used to filter pollutants from surface runoff before reaching a body of water or stormwater management structure

Flat - Section of stream with current too slow to be classed as riffle and too shallow to be classed as a pool. Stream bottom usually composed of sand or finer materials, with coarse rubble, boulders or bedrock occasionally evident.

Flexible Channel Liner - An open-textured, three-dimensional rolled product manufactured from non-degradable materials which is laid on the prepared soil surface to act as a substrate for the establishment of grass cover in open waterways.

Flood Plain - The relatively flat area adjoining the channel of a natural stream which has been or may be hereafter covered by flood water.

Flood Routing - Determining the changes in the rise and fall of flood water as it proceeds downstream through a valley or through a reservoir.

Flume - A device constructed to convey water on steep grades lined with erosion-resistant materials.

Freeboard - The vertical distance between the elevation of the design highwater and the top of the dam, dike, levee or diversion ridge.

Froude Number - The ratio of inertial to gravity forces in flowing water. It is used to classify the flow as subcritical, critical or supercritical (e.g. $N_f > 1$, $N_f = 1$ or $N_f < 1$) Froude number is expressed as:

$$N_f = \frac{V_{channel}}{\sqrt{2gd}}$$

Where d is the hydraulic flow depth

Geotextile - A broad range of fabric type materials which contain or filter soil or water. Fabrics may be permeable or impermeable and may or may not be degradable.

Grade Stabilization Structure - A structure for the purpose of stabilizing the grade of a watercourse, thereby preventing further headcutting or lowering of the channel grade.

Grading - Any stripping, cutting, filling, stockpiling, or any combination there-of and shall include the land in its cut or filled condition.

Grassed Waterway - A natural or constructed channel, usually broad and shallow, covered with erosion resistant vegetation, used to conduct surface water.

Hood Inlet - A pipe entrance wherein the top edge of the pipe is extended 3/4 of the diameter beyond the bottom invert cut on an angle.

Hydraulic Conductivity - A coefficient describing the rate at which water can move through a permeable medium.

Hydrograph - A graph showing for a given point on a stream or for a given point in any drainage system, the discharge, stage, velocity, or other property of water with respect to time.

Hydroseeding - The application of a seed - fertilizer liquid slurry to the soil surface of the prepared seedbed using an apparatus consisting of a storage tank, pump and hose.

Inoculant - A peat carrier impregnated with bacteria and applied in powder or slurry form to legume seed at the time of planting, which form a symbiotic relationship enabling legumes to utilize atmospheric nitrogen for plant growth. Most legumes require specific bacteria.

Impact Basin - A device used to dissipate the energy of flowing water. Generally constructed of concrete in the form of a depressed and partially submerged vessel and may utilize baffles to dissipate velocities.

Land - Any ground, soil or earth including marshes, swamps, drainageways and areas not permanently covered by water.

Liquid Limit - The moisture content at which the soil passes from a plastic to a liquid state. In engineering, a high liquid limit indicates that the soil has a high content of clay and a low capacity for supporting loads.

Liquid Mulch Binder - Organic, synthetic and asphaltic based materials which are physiologically harmless to plant growth and not result in a phytotoxic effect, mixed with water and applied to straw, hay mulch or salt hay to anchor mulching materials together and prevent movement.

Mannings Formula - A formula used to predict the velocity of water flow in an open channel or pipeline:

$$V = \frac{1.49}{n} R^{\frac{2}{3}} S^{\frac{1}{2}}$$

wherein "V" is the mean velocity of flow in feet per second; "R" is the hydraulic radius; "S" is the slope of the energy gradient or for assumed uniform flow the slope of the channel in feet per foot; and "n" is the roughness coefficient or retardance factor of the channel lining.

Mulching - The application of plant residue or other suitable materials to the land surface to conserve moisture, hold soil in place, aid in establishing plant cover and minimize temperature fluctuation.

Mulch Netting - Paper, jute, cotton or plastic netting materials applied to seeded and mulched areas, usually on slopes or critical areas to prevent erosion and promote seedling establishment.

Mulch Blanket - Plastic netting lined with straw or excelsior fibers, placed and anchored onto seeded areas, usually on slopes or critical areas to prevent erosion and promote seedling establishment.

Outlet - Point of water disposal from a stream, river, lake, tidewater, or artificial drain.

Peak Discharge - The maximum instantaneous flow from a given storm condition at a specific location.

Pelletized Mulch - Compressed and extruded paper or wood fiber product which may contain copolymers, tackifiers, fertilizer and coloring agents, applied a dry form to seed bed and activated with water to form a mulch mat. Uniform distribution and adequate initial watering of the mulch is critical to optimum results.

pH - A measure of acidity or basicity of soil with pH 7 being neutral and pH 6.5 being a desirable degree of soil acidity for growth of grasses and legumes. Basicity above pH 7 is rare in eastern U.S. soils.

Pipe Drop - A circular conduit used to convey water down steep grades.

Plant Hardiness Zone - Geographic regions differentiated by climate and growing conditions.

Plasticity Index - The numerical difference between the liquid limit and the plastic limit; the range of moisture content within which the soil remains plastic.

Plastic Limit - The moisture content at which a soil changes from a semisolid to a plastic state.

Plunge Pool - A device used to dissipate the energy of flowing water that may be constructed or made by the action of flowing. These facilities may be protected by various lining materials.

Pool - Section of stream deeper and usually wider than normal with appreciably slower current than immediate upstream or downstream areas and possessing adequate cover (sheer depth or physical condition) for protection of fish. Stream bottom usually a mixture of silt and coarse sand.

Preformed Scour Hole - An area at the outlet end of a storm drain at an elevation essentially the same as the outlet invert which has been excavated and lined with stone which provides both vertical and lateral expansion downstream of the outlet to permit dissipation of excess kinetic energy in turbulence.

Principal Spillway - Generally constructed of permanent material and designed to regulate the normal water level, provide flood protection and/or reduce the frequency of operation of the emergency spillway.

Pure Live Seed - The desired amount of any warm season grass seed to be planted for temporary and permanent stabilization which excludes the weight of inert matter, non viable and undesirable seed as expressed on the seed tag. A practical adjustment is made by multiplying the weight of the bag of seed x per cent purity x per cent germination = the amount of pure live seed contained in the bag.

Rational Formula - $Q=CIA$. Where "Q" is the peak discharge measured in cubic feet per second, "C" is the runoff coefficient reflecting the ratio of runoff to rainfall, "I" is the rainfall intensity for the duration of the storm measured in inches per hour, and "A" is the area of the contributing drainage area measured in acres.

Retention Basin - A stormwater management basin which provides storage for a permanent pool of water below the stormwater management storage volume elevation.

Ridge - The bank or dike constructed on the downslope side of a diversion.

Riffle - Section of stream containing gravel and/or rubble, in which surface water is at least slightly turbulent and current is swift enough that the surface of the gravel and rubble is kept fairly free from sand and silt.

Riprap - Angular broken rock placed on earth surfaces, such as the face of a dam or the channel of a stream for protection against the action of water.

Riser - The inlet portion of a drop inlet spillway that extend vertically from the pipe conduit barrel and control the water surface

Scour Hole - See preformed scour hole.

Sediment - Solid material, both mineral and organic, that is in suspension, is being transported, or has been moved from its site of origin by air, water, gravity or ice.

Sediment Basin - A depression formed by the construction of a barrier or dam built at suitable locations to retain rock, sand, gravel, silt or other material.

Soil - The unconsolidated mineral and organic material on the immediate surface of the earth that serves as a natural medium for the growth of land plants.

Soil Bioengineering - The use of native plant species together with natural materials (rocks, logs, and vegetative byproducts such as coconut fiber) and hydrologic, hydraulic and soil engineering principles to provide restoration to streambanks, slopes and open water shorelines which are subject to the forces of wind and water erosion.

Soil Horizon - A layer of soil, approximately parallel to the surface. that has distinct characteristics produced by soil-forming processes.

Spillway - A form of principal spillway.

Stability - A condition within a channel or on a landform such that flowing water will not erode the soil surface.

Stabilized Center Section - an area in the bottom of a grassed waterway protected by stone, asphalt, concrete or other materials to prevent erosion.

Storm Frequency - An expression or measure of how often a hydrologic event of given size or magnitude should on an average be equaled or exceeded. The average should be based on a reasonable sample.

Straight Drop Spillway - A form of principal spillway.

Straw - The natural dry stem and related material threshed of its seed.

Tailwater - The depth of the receiving water at the end of the apron.

Temporary Protection - Stabilization of erodible or sediment-producing areas.

Toe Drain - A drainage system constructed in the downstream portion of an earth dam or levee to prevent excessive hydrostatic pressures.

Trash Rack - A device used to prevent debris from entering a spillway or other hydraulic structure.

Topdressing - The application of additional nitrogen based fertilizer to vegetation as a follow-up to initial fertilizer applications to help combat nitrogen deficiency.

Underdrains - Pipelines of tile with open joints or perforated pipe used for the collection of subsurface water.

Unified Soil Classification System - A classification system based on the identification of soils according to their particle size, gradation, plasticity index and liquid limit.

Uplift Forces - Vertical pressures acting upward on a structure, usually caused by a buoyant condition.

Vegetative Protection - Stabilization of erosive or sediment producing areas by covering the soil with:

- a. Permanent seeding, producing long-term vegetative cover,
- b. Short-term seeding, producing temporary vegetative cover, or
- c. Sodding, placement of cultivated sod onto prepared topsoil causing instant soil stabilization.

Velocity - The rate of flow measured in feet per second.

Warm Season Mixture - Grasses or legumes which maximize growth at temperatures below 85 degrees F.

Waterway - A natural course or constructed channel for the flow of water. See grassed waterway.

Watershed - a geographic area defined by topographic high points such that precipitation falling within the boundaries of the high points drains to a single outlet, such as a mouth of a stream, lake or river.

SOIL CONSERVATION DISTRICTS IN NEW JERSEY 2014

<p>BERGEN 700 Kinderkamack Road, Suite 106 Oradell 07649 201-261-4407 201-261-7573 (fax) 973-538-1552* www.bergenscd.org info@bergenscd.org</p>	<p>BURLINGTON 1971 Jacksonville-Jobstown Rd. Columbus 08022 609-267-7410 609-267-3347 (fax) 609- 267-0811* www.bscd.org reitmeyer@bscd.org</p>	<p>CAMDEN 423 Commerce Lane, Suite 1 W. Berlin 08091 856-767-6299 856-767-1676 (fax) 856-267-0811* www.camdenscd.org craig.mcgee@camdenscd.org</p>
<p>CAPE-ATLANTIC Atlantic County Office Building 6260 Old Harding Highway Mays Landing 08330 609-625-3144 609-625-7360 (fax) 856-205-1225* www.capeatlantic.org capeatlanticscd@comcast.net</p>	<p>CUMBERLAND-SALEM PO Box 68, 1516 Route 77 Deerfield 08313 856-451-2422 856-451-1358 (fax) 856-205-1225* or 856-769-1126* www.cumberlandsalemsoil.com cumbsoil@aol.com</p>	<p>FREEHOLD (Monmouth & Middlesex) 4000 Kozloski Road PO Box 5033 Freehold 07728 732-683-8500 732-683-9140 (fax) 732-462-0075* www.freeholdscd.org info@freeholdscd.org</p>
<p>GLOUCESTER 14 Parke Place, Suite C Sewell, NJ 08080 856-589-5250 856-256-0488 (fax) 856-769-2790* gloucesterscd.org gloucester@gloucesterscd.org</p>	<p>HUDSON-ESSEX & PASSAIC 15 Bloomfield Avenue North Caldwell 07006 973-364-0786 973-364-0784 (fax) 973-538-1552* www.hepsoilnj.org information@hepsc.org</p>	<p>HUNTERDON 687 Pittstown Road, Suite 1 Frenchtown, NJ 08825 908-788-9466 908-788-0795 (fax) 908-782-4614 ext. 3* www.hcscd.weebly.com hcscd687@embarqmail.com</p>
<p>MERCER 508 Hughes Drive Hamilton Square 08690 609-586-9603 609-586-1117 (fax) 908-852-2576 ext. 3* http://mercercsd.org mercersoil@aol.com</p>	<p>MORRIS PO Box 900 30 Schulyer Place Morristown 07963 973-285-2953 973-285-8345 (fax) mcsd.org morris@mcsd.org</p>	<p>OCEAN 714 Lacey Road Forked River 08731 609-971-7002 609-971-3391 (fax) 609-267-0811 ext 115* www.soildistrict.org info@soildistrict.org</p>
<p>SOMERSET-UNION Somerset County 4-H Center 308 Milltown Road Bridgewater 08807 908-526-2701 908-526-7017 (fax) 908-782-4614 ext. 3* www.co.somerset.nj.us/publicworks/soil/index.html SoilConsrv@co.somerset.nj.us</p>	<p>SUSSEX 186 Halsey Rd, Suite 2 Newton 07860 973-579-5074 973-579-7846 (fax) 908-852-2576 ext. 3* www.sussexcd.org sussex@sussexcd.org</p>	<p>WARREN 224 Stiger Street Hackettstown 07840 908-852-2579 908-852-2284 (fax) 908-852-2576 ext. 3* smyers@warrencountyscd.com www.warrencountyscd.com</p>
	<p>State Soil Conservation Committee New Jersey Department of Agriculture PO Box 330, Trenton, New Jersey 08625 609-292-5540 609-633-7229 (fax) www.state.nj.us/agriculture frank.minch@ag.state.nj.us</p>	<p>*USDA-NRCS Field Office</p>

Investigation, Design and Remedial Measures for Areas Underlain by Cavernous Limestone

Introduction

Carbonate rocks, including limestone, dolomite and marble, underlie the land surface in many areas of northwestern New Jersey (Figure A10- 1). Carbonate rocks primarily occur in valleys, because they are easily eroded. Soil erosion processes in areas underlain by carbonate bedrock are unique, because carbonates are highly susceptible to chemical erosion ("solutioning") and their associated soils subject to collapse. Weak acids formed by the combination of infiltrating ground water and carbon dioxide in the soil attack carbonate rocks, causing the formation of voids, known as solution cavities, in these otherwise competent rocks. Sinkholes, caves, disappearing streams, springs, bedrock pinnacles, and "blind valleys" develop on soluble carbonate rock. These features are characteristic of a type of landscape known as "karst."

Percolation of surface water can cause a migration of soil into solution cavities, forming "sinkholes" at the surface. Sinkholes cause instability of the land surface and must be given serious consideration in the development of soil and sediment erosion control plans. Sinkhole formation is often accelerated by construction activities that modify a site's hydrology or disturb existing soil and bedrock conditions. Ground failure in karst areas is most often caused by the alteration of drainage patterns, emplacement of impervious coverage, excessive grading, and increased loads from site improvements.

An awareness of the limitations to site development posed by karst features can prevent problems, including damage to property, structures and life, and contamination of ground water. Appropriate site testing, planning, design, and remediation help to prevent sinkhole formation during site development. Conventional methods of design and engineering may be inappropriate for karst areas. Often minor modifications in the approach to site testing and design can prevent persistent and costly post-development problems.

Site testing for detection of potential karst-related problems

The most effective and economical approach to designing and installing a successful soil erosion and sediment control system in karst areas is to evaluate the potential for ground failure by first collecting easily obtainable information on surface and subsurface conditions prior to construction activities. Applicants filing for certification of Soil Erosion and Sediment Control Plans are encouraged to determine if their site lies within an area underlain by carbonate bedrock. Figure 1 shows the occurrence of carbonate units in northern New Jersey. To obtain more detailed geologic maps, applicants may contact the New Jersey Geological Survey at the following address:

New Jersey Geological Survey
P.O. Box 427
Trenton, N.J. 08625
609-292-2576 or 292-1185

Various methods are available to collect information about the bedrock and soil conditions at a proposed development site. These can range from inspecting topographic and geologic maps and aerial photographs of the site, to drilling test borings at the location of planned facilities. Professionals involved with projects in karst areas should make a special effort to observe signs of ground subsidence during development

Site evaluation for karst features is usually carried out in two phases: (1) *preliminary site investigation*, done prior to site design and development, and (2) *site-specific investigation*, conducted once the decision is made to design a site plan and proceed with development.

Preliminary site investigation includes a review of topographic and geologic maps, soil surveys, aerial photography, and any previous technical reports prepared for the site. This phase of investigation should include a site visit, where the experienced professional studies the site terrain in an effort to locate any obvious features, such as rock outcrops, sinkholes, springs, caves, etc. The purpose of the preliminary investigation is to identify areas of concern

that may require additional investigation, and to review the preliminary site design in relationship to potential problem areas. The preliminary site investigation will often result in immediate changes to the site layout to avoid future problems.

Site-specific investigation includes collecting subsurface information at sites identified as potential problem areas during the preliminary investigation. During the site-specific investigation process the professional may examine subsurface soil and geologic conditions using test pits, test borings, and geophysical instruments to evaluate the stability of soil and rock at locations of proposed site facilities. If unstable subsurface conditions are encountered, a decision can be made to proceed to remediate prior to construction or to modify the site layout to avoid problem areas. The record of findings during this phase of the investigation includes logs of test pits, probes and borings, noting evidence of cavities in soil and rock, loss of air pressure or drilling fluid during drilling, and the condition of soil and bedrock from samples collected.

Table K-1 lists the steps in the preliminary site investigation and the site-specific investigation, methods of collecting data, objectives of each step, and the application of information obtained. A discussion of the various site investigation methods follows:

Geologic maps: Geologic maps contain information on the physical characteristics and distribution of the bedrock and/or unconsolidated surficial deposits in an area. Geologic features such as the strike and dip of strata, joints, fractures, folds, and faults are usually depicted. The orientation of strata and geologic structures generally controls the location and orientation of solution features in carbonate rock. Geologic contacts, faults, and certain fractures sets may be more prone to solution than others. The relationship between topography and the distribution of geologic units may reveal clues about the solubility of the specific rock units. Geologic maps are often available at various scales, the most common being 1:24,000. Digital geologic data may be available as well.

Aerial photography: Aerial photos are a simple, quick method of site reconnaissance. Inspection of photos can quickly reveal vegetation and moisture patterns that provide indirect evidence of the presence of cavernous bedrock. Piles of rock or small groups of brush or trees in otherwise open fields can indicate active sinkholes or rock pinnacles protruding above the ground surface. Circular and linear depressions associated with sinkholes and linear solution features and bedrock exposures are often visible when viewed in stereo image. Inspecting photos taken on more than one date can be especially valuable in revealing changes that take place over time. Images defined at wavelengths other than visible light can be useful in detecting vegetative or moisture contrasts.

Site visit: An on-site reconnaissance is an inexpensive, important step in finding potential site constraints. Although many karst features are obvious to the eye, it is an advantage to conduct the site visit with an individual knowledgeable in karst geology. Prior to the site visit field personnel should review geologic maps, topographic maps, and air photos to help anticipate where problems might be found. It is important to review drainage patterns, vegetation changes, depressions, and bedrock outcrops to look for evidence of ground subsidence. Sinkholes in subdued topography can often only be seen at close range. Disappearing streams are common in karst areas, and bedrock pinnacles that can be a problem in the subsurface will often protrude above the ground surface. A particularly simple and often overlooked part of the site visit is to interview the property owner. Often property owners can recount a history of problems with ground failure that may not be evident at the time of the site evaluation. The location of karst features should be noted on the site map for later reference. These can be compared to other information collected to assess the risk potential for karst-related problems.

Figure K-1

Limestone Geology of Northern New Jersey

Limestone bedrock is found throughout northern New Jersey. The term limestone can be used to refer to rocks that include marble, dolomite, or true limestone. Marble or "White Limestone" is found in a few places in northeastern New Jersey and throughout the New Jersey Highlands. Cambrian and Ordovician age limestone and dolomite are found in the valleys in the Highlands and in the Kittatinny Valley in northwestern New Jersey. Younger Silurian and Devonian age limestone is found in the Green Pond Mountain region and in the Upper Delaware River and Minisink Valleys. All of these limestones are susceptible to chemical solution and the formation of karst landscape.

Note: Depth from surface to formations varies greatly throughout the region.

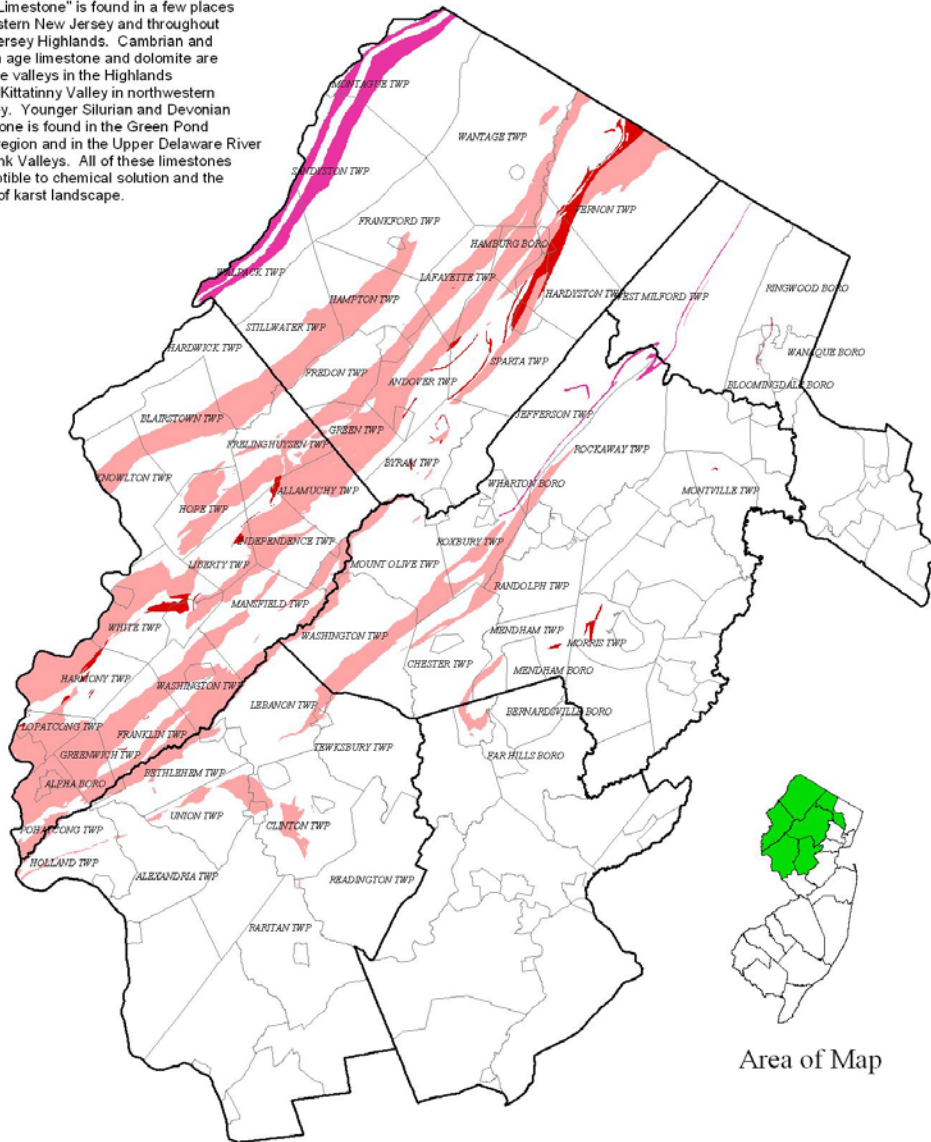

- Silurian and Devonian age limestone
- Cambrian and Ordovician age limestone and dolomite
- Precambrian age marble
- County boundaries
- Municipal boundaries



Source: New Jersey Geological Survey
Geologic Map of New Jersey
(USGS Map I-2540-A, 1996)

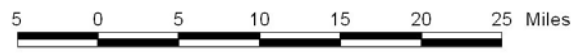

Test pits: Test pit excavations are a simple, direct way to view the condition of soils that may reveal the potential for ground subsidence, and to inspect the condition and variability of the limestone bedrock surface where bedrock is sufficiently shallow. Soil texture is an important indicator of soil strength and, therefore, the ability of soils to bridge voids. An inspector should look for evidence of slumping soils, former topsoil horizons, and fill (including surface boulders, organic debris, and other foreign objects) in the test pit. Voids in the soil or underlying bedrock can be revealed. The presence of organic soils at depth is an indicator of potentially active sinkhole sites. Leached or loose soils may also indicate areas of existing or potential ground subsidence. Observations of this type should be recorded in the soil log.

Test probes: Test probes are performed by advancing a steel drill bit into the ground using an air-percussion-drilling rig. Probes can be installed rapidly and are an effective way to quickly test subsurface conditions. Penetration depths are usually less than 50 feet. During the installation of a test probe the inspector should be aware of the rate of advance of the drill bit, sudden loss of air pressure, soft zones, free-fall of the bit, and resistant zones. These observations can provide clues to the competency of the bedrock and the presence of cavities in soil or bedrock. The volume of fluid cement grout needed to backfill the probe hole can yield a measure of the size of subsurface voids encountered during drilling.

Test borings: Test borings often yield virtually complete and relatively undisturbed soil and rock samples. Borings may provide direct evidence of the presence and orientation of fractures, weathering, fracture fillings and the vertical dimensions of cavities, and provide undisturbed samples that can be subjected to laboratory testing. Use of a split inner core barrel in rock coring provides the most meaningful results, because this method collects a relatively undisturbed sample in the core barrel. Losses of drilling fluid can indicate the presence of soil or rock cavities. When drill holes are sealed, the volume of fluid cement grout placed in the drill hole can also yield a measure of the size of openings in the subsurface. All borings must be performed by a well driller or test borer licensed by the New Jersey Department of Environmental Protection under N.J.S.A. 58:4A-4.1 et seq. Borings should be sealed after completion. Borings less than 25 feet deep may be sealed with cuttings from the boring. Borings in excess of 25 feet must be sealed according to procedures published by the NJDEP Bureau of Water Allocation (609-292-2957).

Geophysical methods: Geophysical methods can serve as a rapid reconnaissance tool to detect physical anomalies in the subsurface that may be caused by karst features. These methods are especially suited to surveying linear corridors, and are non-disruptive to the land. Geophysical data are often useful for extrapolating between locations where other sampling methods are used. Generally it is advisable to apply more than one geophysical technique, owing to the variability in physical properties of karst terrain. Geophysical methods require an experienced professional to interpret the data collected. The properties of weathered limestone, including a highly variable bedrock surface and soils with high clay content, often hinders the depth of penetration and resolution of geophysical signals and can compromise the effectiveness of geophysical surveys. Despite these limitations, geophysics can sometimes provide a cost-effective, relatively rapid means of determining the potential for problems with karst features, including the location of shallow bedrock and significant cavities in the soil or bedrock. Geophysical anomalies should be targeted for additional direct testing procedures.

Table K-1: Investigative Methods for Sites Underlain by Carbonate Bedrock

Tool	Sources	Subject of Interest	Significance
Phase 1 - Preliminary site investigation			
Geologic maps	New Jersey Geological Survey (1) United States Geological Survey (2) County planning agencies Township environmental resources inventory Original report for site by qualified geologist	Is carbonate rock present	Indicates karst risk present
		Risk level based on geologic unit(s) present	Indicates possible extent of problem
		Presence and location of faults and folds	Indicates condition of rock, location of high-risk areas
		Orientation of strata and joints	Indicates relationship of karst features to one another
Aerial photography	U.S.D.A. Natural Resource Conservation Service (3) N.J.D.E.P. Land Use Regulation Program (4) New Jersey Geological Survey (1) United States Geological Survey (5) Private aerial survey firms	Land cover for site	Significance of previous land use
		Location of hedge rows	High probability areas for sinkhole
		Presence of vegetation in cultivated fields	High probability areas for sinkholes and outcrops
		Circular patterns	High probability areas for sinkholes
		Linear patterns	Presence of "sags," outcrops, faults, fracture zones
		Differential shading	Subsurface drainage patterns
Topographic maps	United States Geological Survey (2) New Jersey Geological Survey (1) Private camping stores, bookstores	Site relief	Presence of steep slopes
		Site drainage patterns	Natural or modified drainage
		Natural depressions	High probability areas for sinkholes
		Land cover	Significance of previous land use
Site field visit	Observations of reconnaissance party Observations of previous owners or land users	Previous experiences with sinkholes, springs, etc.	History of karst-related problems
		Land-use changes over time	Controlling factors on land use
		Drainage patterns	Surface drainage patterns; disappearing streams, springs
		Identification of features on maps, photos	Identification of potential karst hazards, test sites
Phase 2 - Site-specific investigation			
Test pits	Previous logs collected at site Logs performed on site	Presence of voids in soil	High probability areas for sinkholes
		Presence of soft or organic soils	Previous sinkhole activity; high risk for reactivation
		Depth to shallow bedrock	Obstacles to underground facilities; pollution hazard
		Voids in bedrock	High probability areas for sinkholes; pollution hazard
		Condition of shallow bedrock	Risk to excavation, loads
		Bedrock topography	Need for excavation, blasting.
Test probes	Private drilling or blasting firms (percussion probe)	Thickness of unconsolidated overburden	Potential for or potential size of, subsidence features
		Competency of unconsolidated overburden	Potential for ground subsidence
		Presence of voids in soil	High probability areas for sinkholes; need for foundation elements
		Presence of voids in bedrock	High probability areas for sinkholes; need for foundation elements
		Condition of bedrock	Foundation element design
		Circulation of air in rig	Presence of voids
Test borings	Private drilling firms (coring rig)	Condition of unconsolidated overburden	Potential for subsidence; foundation design
		Voids in unconsolidated overburden	Potential for or potential size of subsidence features
		Condition of bedrock	Sinkhole risk; foundation element design
		Voids in bedrock	Presence and size of voids/sinkhole risk
		Water circulation	Presence and size of voids in overburden or bedrock
Geophysical surveys	Private geotechnical firms	Geophysical anomalies	Potential location and size of karst features Location for additional subsurface data collection
		Bedrock topography	Need for excavation, blasting.

(1) New Jersey Geological Survey, P.O. Box 147, Trenton, NJ 07825, 609-292-2576, 609-633-1004 (fax), URL: <http://njgs.state.nj.us>(2) U.S. Geological Survey, Information Services, Box 25286, Denver, CO 80225, 1-800-USA-MAPS, 303-2-2-4693 (fax), URL: http://mapping.usgs.gov/esic/to_order.html (local dealers also available)

(3) USDA Natural Resources Conservation Service, State Soil Scientist, 732-246-1171, ext. 170

(5) U.S. Geological Survey, EROS Data Center, Customer Services, Sioux Falls, SD 57198, 605-594-6151, 605-594-6589 (fax),

e-mail: custserv@edcmil.cr.usgs.gov, URL: <http://edcwww.cr.usgs.gov/eros-home.html>

Procedures to follow if karst features are identified during investigation

The site investigations described above may reveal the location of suspected areas of ground subsidence. These findings should be compared to the proposed layout of site facilities. Wherever possible, facilities should be sited to avoid suspected areas of potential ground subsidence. Where relocation of facilities is not practical, remedial measures and design standards can be employed to minimize future ground failure. Remedial sealing of voids in the soil or bedrock and /or compaction of soil and rock voids may be a viable in some areas.

Site Design and Construction General Guidelines

Site design and construction procedures can be important in reducing the risk of sinkhole development. Sinkholes most often form in areas where storm-water runoff is concentrated, where bearing loads are concentrated, and where ground water is pumped in large volumes. When development is proposed consideration should be given to the following general guidelines to minimize the risk of ground failure:

Minimize site disturbance, including cuts and fills and drainage alteration.

Minimize impervious surface so as to minimize the volume of surface runoff generated.

Employ storm-water management measures that minimize flow velocities and ponding to avoid erosion of over-saturation of soils.

Waterproof pipefittings and pipe-to-basin fittings to minimize underground leaks. Leaks weaken and erode soils around underground conduits.

Place foundations on sound bedrock.

Soil Erosion and Sediment Control Facilities General

The selection, design, and implementation of soil erosion and sediment control practices in karst areas should be guided by the following objectives and should incorporate the following design elements:

The site should be designed to take maximum advantage of topography. Modifications of site topography should be minimized.

Changes to the existing soil profile, including cuts, fills, and excavations, should be minimized.

Where practical, drainage facilities should consist of embankments at or above grade. Excavation into the existing soil profile to construct swales and basins should be minimized to the degree possible.

Temporary and final grading of the site should provide for drainage of storm-water runoff away from structures.

All storm-water management facilities, including grassed waterways, diversions and lined waterways, should be designed to disperse the flows across the broadest channel area possible. This reduces the level of soil saturation and reduces the potential for soil movement. Shallow trapezoidal channel cross sections are preferred over parabolic or v-shaped channels.

Sedimentation and detention basins should be used as a last resort for sediment control in karst areas, and should be used only after other designs have been considered and rejected. Consideration should be given to constructing basins required for permanent storm-water detention at the end of the project, after the site has been stabilized. Vegetative cover should be established as rapidly as possible over exposed areas. Construction scheduling should strive to minimize the time that soil excavations are open and non-vegetated. This reduces the time that the site is exposed to periods of concentrated flows as well as preventing excessive drying of soils.

Utility trenches should be back filled with in-situ soils or low permeability fill material to discourage sub-surface water flow along the trench. Clay dams may be used at intervals along the trench excavation to impede subsurface flow along the trench. Trench backfill should be compacted to prevent future settlement and ponding. Backfill densities for open areas should exceed 90% of ASTM D-1557 maxima. Densities for areas supporting structures such as roadways should equal or exceed 95% ASTM D-1557 maxima. All underground piping should have water -tight fittings. The piping should be designed to withstand some limited displacement due to the probable ground settling and/or downward migration of trench bedding material into solution features.

Storm-water facilities design waterways

Storm-water conveyance structures to be used in karst areas should be designed in such a way as to dissipate overland flow over the largest area possible. Every attempt should be made to avoid concentration of flows and ponding. Grassed waterways can be effective storm-water-diversion structures in karst areas. Particularly effective are waterway designs that are shallow and broad, providing maximum bottom width and wetted perimeter to disperse flow over the greatest area. Grassed waterways in karst areas should be designed in accordance with standards provided in "Standard for Grassed Waterways" (pg. 18-1).

Storm-water facilities design sedimentation and detention basins

Sedimentation and detention basins in karst areas have a poor performance history. Collapse of the basins and basin inlet and outlet structures is common. Detention basins are particularly vulnerable to collapse in karst areas, because they are designed to concentrate and detain surface-water runoff. Ponding and associated soil saturation occur where surface-runoff is concentrated. Saturation of fine-grained soils that develop on weathered limestone can cause reduction in soil strength and erosion into bedrock voids.

Methods traditionally used to reduce or eliminate excessive seepage from an impounded area may have limited success in limestone areas. Traditional sealing methods include compaction, clay blankets, bentonite treatment and flexible membrane liners. The sealing of the solution channels in bedrock beneath the basin area can reduce seepage and soil displacement into underlying voids.

When they function properly, detention basins can be effective in removing contaminants commonly found in storm water, including heavy metals, nutrients, herbicides, pesticides, solids, and bacteria. Most of these contaminants are attenuated by sedimentation and soil filtration in the basin bottom. Sinkholes undermine the beneficial effects of basins on water quality by allowing introduction of untreated surface runoff directly to ground water. They "short-circuit" the hydraulic benefits of basins by allowing bypassing of outlet structures.

Detention basin sites can be evaluated and facilities designed and retrofitted to guard against sinkhole formation and improve performance from a water-quality perspective. Testing procedures and design elements recommended to minimize detention basin failure include:

Minimize the coverage of the site by impervious surfaces, so that detention basin size will be minimized.

Evaluate soil texture. The basin should be constructed to minimize excessive seepage (Fig. K-2). Highly cohesive soils such as silt and clay loams may require minimum preparation of basin bottoms. Soils with low cohesive strength, such as sandy loams may require compaction and/or replacement or modification by the addition clay binders or by installation of liners. Acceptable practices for installing liners are summarized in Table K-2.

Investigate soils and bedrock below the basin for presence of voids. Repair existing voids and/or perform preventative grouting of basin substrate.

- Basin profiles should be broad and flat to allow maximum dispersion of detained flow.
- Basin bottoms should be smooth to avoid ponding.

- Inlet and outlet structures should be designed to provide diffuse discharge of water; avoid concentration of flows. Under drains are preferred to provide gradual discharge of water and to avoid prolonged ponding of water. Refer to Appendix A-7 for sediment basins for design and installation of under drains.
- Repair sinkholes that occur in basin after construction.

Table K-2. Appropriate liners for sedimentation and detention basins

Practice Standard (1)	Practice
521-A	Pond sealing or lining - Flexible membrane
521-B	Pond sealing or lining - Soil dispersant
521-C	Pond sealing or lining - Bentonite sealant
521-D	Pond sealing or lining - Cationic emulsion waterborne sealant
521-E	Pond sealing or lining - Asphalt sealed fabric liner

(1) USDA National handbook of conservation practices, IV. Standards and practices.

Figure K-2 Determination of Specific Discharge

Determination of Specific Discharge:

1. Given: $Q = K \cdot (h/d) \cdot A$ (Darcy's Law)
2. Where: Q = discharge (seepage)
 K = hydraulic conductivity of soil (this is the permeability "k" commonly used in soil engineering)
 (h/d) = hydraulic gradient
 h = maximum vertical distance measured between the top of the manure and the bottom of the soil liner
 d = depth of soil liner
 A = cross-sectional area of flow
3. Rearranging terms:
 $Q/A = K \cdot (h/d)$
4. Or: $K \cdot (h/d) = v$
5. Where: v = specific discharge, or seepage per unit area; v has the dimensions of velocity, ie, distance/time. \downarrow

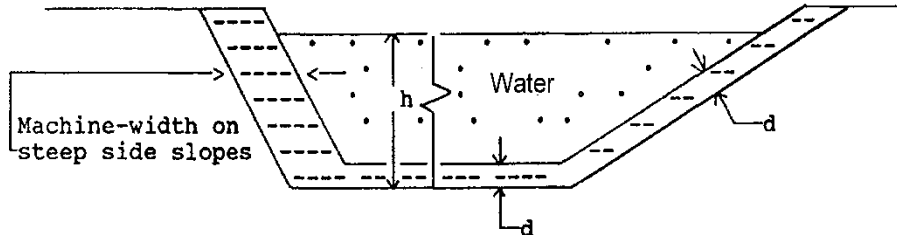

Figure 1: Schematic Relationship of Liner to Hydraulic Gradient

\downarrow Specific discharge with units of velocity is a theoretical velocity through the full cross-sectional area (comprised of pores and solids alike). Actual flow moves only through the soil pores, the area of which can be computed by multiplying the full cross-sectional area (A) by porosity (n). A seepage front moves at the rate of specific discharge divided by porosity (v/n). In compacted fine grained soil porosity will usually range from 0.3 to 0.5. This gives an average linear velocity of the seepage front approximately 2 to 3 times the specific discharge.

REF: NRCS, AWMF Amend. N3
March 1988

Blasting

Rock blasting with explosives can cause soil collapse and cavern collapse, leading to sinkhole development. Specific guidance should be developed in accordance with applicable state and federal laws. For further information on applicable state laws contact the New Jersey Department of Labor, Office of Safety Compliance (609-292-2096). Blasting guidelines are designed to protect structures against damage. Mobilization of unstable soils or rock in karst areas may be brought about at velocities lower than those specified in the regulations.

Response and remediation of sinkholes occurring during construction

It is common for sinkholes to form during construction of a project. Sinkholes that occur during construction should be repaired immediately to prevent their enlargement and associated adverse impacts. When sinkholes occur during construction the site supervisor should take the following steps:

- Report the occurrence to the Soil Conservation District within twenty-four (24) hours of discovery;
- Halt construction activities in the immediate area of the sinkhole until it is stabilized. Secure the sinkhole area.
- Direct the surface water away from the sinkhole area, if possible, to a suitable storm-water drainage system.
- Select a remedial measure from Section 2 (following). Communicate proposed remediation plan to the Soil Conservation District. Some jurisdictions may have local requirements for notification and review as well.
- Repair any damage to soil erosion and sediment control improvements and restore ground cover and landscaping;
- In those cases where the hazard cannot be repaired without adversely affecting the soil erosion and sediment control plan design, the applicant should arrange a conference with the Soil Conservation District to discuss modifications to the plan.

The type of repair chosen for any sinkhole depends on its location, the extent and size of the void, the type of infrastructure planned for the sinkhole area, and the financial and technical resources available to the developer of the site. Sinkhole sealing methods can include the use of available on-site materials, dry or wet grout, filter material and geotextiles.

Treatment methods for repairing sinkholes can be found following the bibliography of selected references.

All sinkhole remediation activities should be under the direct supervision of a geologist, or geotechnical engineer with experience in limestone investigations and remediation practices. A certified professional should perform all borings.

Selected References

American Society for Testing and Materials, 1991. ASTM D1557-91, Test method for laboratory compaction characteristics of soil using modified effort (56,000 ft-lb/ft), West Conshohocken, PA.

Beck, B. F. 1984. Sinkhole terminology, in: Proceedings of the First Multi disciplinary Conference on Sinkholes, Orlando, FL.

Fischer, J.A., J.J. Fischer, T.C. Graham, R.W. Greene, and R. Canace. 1984. Practical concerns of Cambro-Ordovician karst sites, in: Proceedings of the First Multi disciplinary Conference on Sinkholes, Orlando, FL, p. 233-237.

Iqbal, M.Ayub. 1995. 'Engineering experience with limestone'. In: Karst GeoHazards, Beck (ed) Balkema, Rotterdam, pp. 463-468.

Kalmes, A. and E. Mohring. 1995. Sinkhole treatment to improve water quality and control erosion in southeastern Minnesota, in: Karst GeoHazards, Beck (ed) Balkema, Rotterdam, pp. 265-272.

Kochanov, W.E. 1995. Storm-water management and sinkhole occurrence in the Palmyra area, Lebanon County, Pennsylvania., in: Karst GeoHazards, Beck (ed.) Balkema, Rotterdam, pp. 285-290.

Newton, J.G. 1984. Review of induced sinkhole development, in: Proceedings of the First Multi disciplinary Conference on Sinkholes, Orlando, FL, p. 3-9.

Natural Resources Conservation Service, USDA. 1995. Sinkhole and sinkhole area treatment. Sinkhole Treatment 370, pp. 1-3.

Sowers, G.F. 1984. Correction and protection in limestone terrain, in: Proceedings of the First Multi disciplinary Conference on Sinkholes. Orlando, FL, pp. 373-378.

U.S. Department of Agriculture (USDA), National Handbook of conservation practices, IV. Standards and practices, (stock no. 001-007-00903-1) Washington D.C.

(USDA manuals and handbooks can be obtained through the National Technical Information Service Research Department, U.S. Department of Commerce, 5285 Port Royal Road, Springfield, VA, 22161, 703-487-4780, 703-321-8541 (fax))

Section 2 - Sinkhole Treatment

Definitions

A sinkhole is a surface depression caused by collapse of soil or bedrock into cavities in soluble bedrock. Sinkhole treatment is the cleaning out, excavation, and back filling of a sinkhole, and treatment of the associated drainage area to prevent its expansion or recurrence.

Purpose

The purpose of sinkhole treatment measures is to repair sinkholes by addressing their cause, which is typically a solution cavity in bedrock. Objectives include stabilization of the ground surface at the site of the sinkhole and prevention of ground-water pollution.

Applicability

Sinkhole treatment practices should be applied where geologic conditions have resulted in the development of sinkholes, where contaminated water and/or soils have the opportunity to enter sinkholes and pollute ground water, and where land management measures can be made more effective by treating sinkholes. Considerations for selecting the appropriate treatment measure include:

- geologic conditions, including depth to bedrock and size of cavernous zone(s);

- dimensions of sinkhole;

- presence or absence of open "throat";

- existing and planned land use;

- sinkhole drainage area;

- quality and volume of surface-water runoff;

- need for filter strip or other water-quality measure;

- nature of "clean-out" material;

- availability and quality of materials;

- project budget;

- safety of labor and equipment during and after treatment.

- proximity to permanent structures.

Planning Considerations

A systematic approach should be used in treating both the sinkhole and its drainage area. A determination must be made as to whether the sinkhole should continue to receive surface-water runoff, or if runoff should be diverted from the treated area. A sinkhole treated in such a way as to continue to receive runoff may be referred to as a "drainage sinkhole." Drainage sinkholes are appropriate where the drainage area is small, water quality is high, or control of the watershed is not feasible. Drainage sinkholes should work in conjunction with water-quality improvement practices, such as conservation cropping systems, nutrient management practices, filter strips, and conservation practices that control sheet, rill, and gully erosion.

The treatment design should not result in ponding of surface water or high soil moisture conditions. Diverting surface water from a sinkhole should be considered if runoff is contributing to its formation or expansion, or if the quality of the runoff entering the sinkhole is unsatisfactory. Surface water can be excluded by sealing the sinkhole and/or diverting runoff away from it. Sinkholes can be sealed by effective compaction of backfill material that minimizes infiltration. The drainage area contributing runoff to the sinkhole area should be minimized to the extent practical through the use of diversions, waterways, graded terraces, surface inlets, or outlets, as required.

Site Investigation Prior to Treatment

A site investigation should be extensive enough to determine if the sinkhole could be treated effectively for the intended purpose. The site investigation should address geology, soils, hydrology and water quality. An area larger than the extant sinkhole may need to be addressed to prevent future sinkhole development.

The geologic investigation of the sinkhole site should be extensive enough to determine the following:

- depth to bedrock;
- susceptibility of bedrock to solution;
- depth to suspected void(s);
- presence of or potential for other sinkholes in the treatment area.

The minimum site-specific soil investigation should be extensive enough to define the following:

- filter requirements of the soil;
- availability of backfill;
- compaction requirements of the backfill;
- moisture changes that may affect stability.

The minimum hydrologic and hydraulic considerations include:

- drainage area to the sinkhole area;
- design runoff rates to the sinkhole if water is to be diverted;
- stable outlets for proposed waterways, diversions, etc.

The minimum water quality considerations include:

- present and future water quality impairments of the inflow;

identification of and nature of the receiving water body and/ or aquifer.

Treatment Methods, Designs, and Procedures

A. Preparation of Sinkhole Prior to Treatment: All Methods

Preparation of the sinkhole is required to insure success using all treatment methods. All needed filter and backfill materials must be on site during preparation of the sinkhole. The following steps are necessary to prepare sinkholes for any of the treatment methods selected:

(1) Clean out

All foreign materials in and around the sinkhole should be removed and properly handled. A landfill disruption permit from the State Department of Environmental Protection may be required prior to disturbing the site. Other county and/or municipal laws, rules or regulations may apply.

(2) Excavation:

Loose soil material should be excavated from the sinkhole in an attempt to expose the cavity in the bedrock. Potable water may be used to flush the soil and expose the void(s). Any weak, exposed bedrock should be intentionally collapsed into the cavity. The sinkhole may have to be enlarged for safety purposes and for the proper placement of backfill or filter materials.

(3) Bridging

All exposed cavities are to be bridged with a material suited to the treatment method planned:

For a drainage sinkhole, rock which is 50 percent larger than the opening should be placed in a layer over the cavity.

For a sinkhole plug, concrete or rock may be used. Where concrete is used, a low slump and/or quick set mix is recommended.

For a sinkhole treatment at site to be used for structures, concrete or grouted rock is required.

B. Sinkhole Treatment Method - Drainage Sinkhole

(1) Application

A drainage sinkhole method should be used where the sinkhole(s) is an integral part of the existing drainage system for the site, such as for sinkholes occurring in swales, watercourse, and receiving depressions. Drainage sinkholes should not be used within the foundation area of a structure. The design consists of placing layers of graded material to bridge the void, allow infiltration of surface water, and percolation of ground water through the layers without causing erosion. Geotextiles may be used as a filter layers if seepage quantities are low and clogging is not suspected to be a problem. The geotextile shall be designed for the anticipated infiltration rate.

(2) Procedure

(a) Preparation: Sinkhole preparation as per Preparation of Sinkhole Prior to Treatment-All Methods (above). Rocks should be used to bridge the sinkhole throat. Excess spoil from the excavation must be disposed of in a proper way (fig. K-3).

(b) Inverted filter: Installation of inverted filter designed to function as a combined filter and drain in accordance with standard engineering practice (fig. K-4). Each filter or drainage layer will consist of a specific gradation of sand, gravel and/or rock, depending on the gradation of the adjoining layer. An acceptable design method is currently contained in the USDA-NRCS National Engineering Handbook,

Chapter 26, Gradation Design of Sand and Gravel Filters.

Typical design: If the base soil is fine grained and the sinkhole is in a low-risk situation (i.e. removed from structures), the typical inverted filter design as shown in figure 1 may be used.

C. Sinkhole Treatment Method - Sinkhole Plug with Inverted Filter

(1) Application

The sinkhole plug method should be used for areas that are not an integral part of the drainage system for the site. It is suitable for areas that shed runoff. It should not be used for sites that will support structures.

The inverted filter design permits percolation of soil moisture while preventing internal erosion. The method employs readily available materials to plug the void. The surface of the finished plug is graded to prevent ponding of surface water.

(2) Procedures

(a) Sinkhole preparation: The sinkhole area should be prepared as per Preparation of Sinkhole for Treatment: All Methods (above). Any method of bridging may be employed. Suitable excavated material should be salvaged for use as backfill.

(b) Inverted filter: The inverted filter shall be designed in accordance with standard engineering practice. Each filter layer will consist of a specific gradation of sand, gravel, or rock, depending on the gradation of the adjoining layer. An acceptable design method is contained in the USDA-NRCS National Engineering Handbook, Chapter 26, Gradation Design of Sand and Gravel Filters.

Typical design: If the base soil is fine grained and the sinkhole is in a low-risk situation, the typical inverted filter design as shown in figure K-2 may be used. A geotextile may be used between the fill layers to prevent migration of materials between layers. This fabric should permit percolation of ground water. The geotextile shall be designed for the anticipated infiltration rate and selected to prevent clogging.

D. Sinkhole Treatment Method - Remedial Grouting

(1) Application

Remedial grouting should be used to treat sinkholes in areas that are near or are intended to support structures, where internal drainage is not a concern. Grouting can be used as a means of sealing the sinkhole throat in connection with sinkhole plugs, as described above. Three types of grouting methods are appropriate for karst areas: slurry grouting, compaction grouting, and "cavity treatment grouting."

Grout is a mix of cement and additives to reduce shrinkage and accelerate or reduce hardening time. Slurry grouting is the filling of a cavity with cement. Compaction grouting is high-pressure injection of grout to fill cavities and displace and/or compress surrounding soils to achieve greater strength. Cavity treatment grouting is a combination of slurry and compaction grouting. Since the grouting methods seal voids, grouting is not recommended in combination with the drainage sinkhole design, except to supplement it by stabilizing areas surrounding the drainage sinkhole.

(2) Procedures

In all grouting methods a hole is drilled into the subsurface cavity(s) in the bedrock or soil and a grout mixture is introduced. The grout mixture is selected based on conditions encountered during treatment. The grout is introduced by pumping via a hose or by gravity via a chute. Backfill of the remaining sinkhole after grouting should follow the above procedures for sinkhole plugging.

(a) Sinkhole preparation: The sinkhole area should be prepared as per Preparation of Sinkhole for Treatment: All Methods (above). Suitable excavated material should be salvaged for use as backfill.

(b) Introduction of grout - slurry grouting (fig. K-5): A lean cement mix (1:1:1 water/mason sand/cement) with an appropriate anti-shrinkage agent (e.g. bentonite) is placed into the void(s) in the soil and/or bedrock in the area of concern (figure 3). Slurry grout can be placed in stages with the use of down-hole packers.

Introduction of grout - compaction grouting: Inject a low-slump (less than 2 inches) grout to displace and/or compress the surrounding soils to achieve greater strength. The grout mix should consist of cement (ASTM C150-97e1 Portland cement Type I), fine aggregate (mason sand, ASTM C144-97), and water with an anti-shrinkage agent (e.g., bentonite) and appropriate accelerators and/or thickeners. The mix should have a slump of less than 4 inches (ASTM C143/C143M-97). The mix should start at 1:5:1 cement: mason sand: water by weight with an anti-shrinkage agent. The mix may be varied as conditions warrant. The low-slump grout placement may be controlled in such a way as to provide structural support for inlet/outlet structures or to close a sinkhole void at depth.

(d) Introduction of grout - cavity treatment grouting (fig. K-6): In this method fluid grout and/or grouted concrete columns are used to fill voids in the bedrock. A good understanding of the subsurface geology of the site is needed to undertake this method. In cavity treatment grouting the decision on the best method to treat the void based on its size and the expertise and equipment available to carry out the remedy. Options include:

(1) the void is small enough to fill economically with cement grout slurry;

(2) the void requires the grout columns within the cavity to reinforce the cavity roof and seal the opening. The columns are installed atop sound rock using cement thickeners, sand or gravel pyramids, and/or accelerating additives.

After grouting a grout seal should be placed over the entrance to the underlying solution cavity to prevent soil erosion into the cavity.

Figure K-3: Drainage Sinkhole - Typical Design

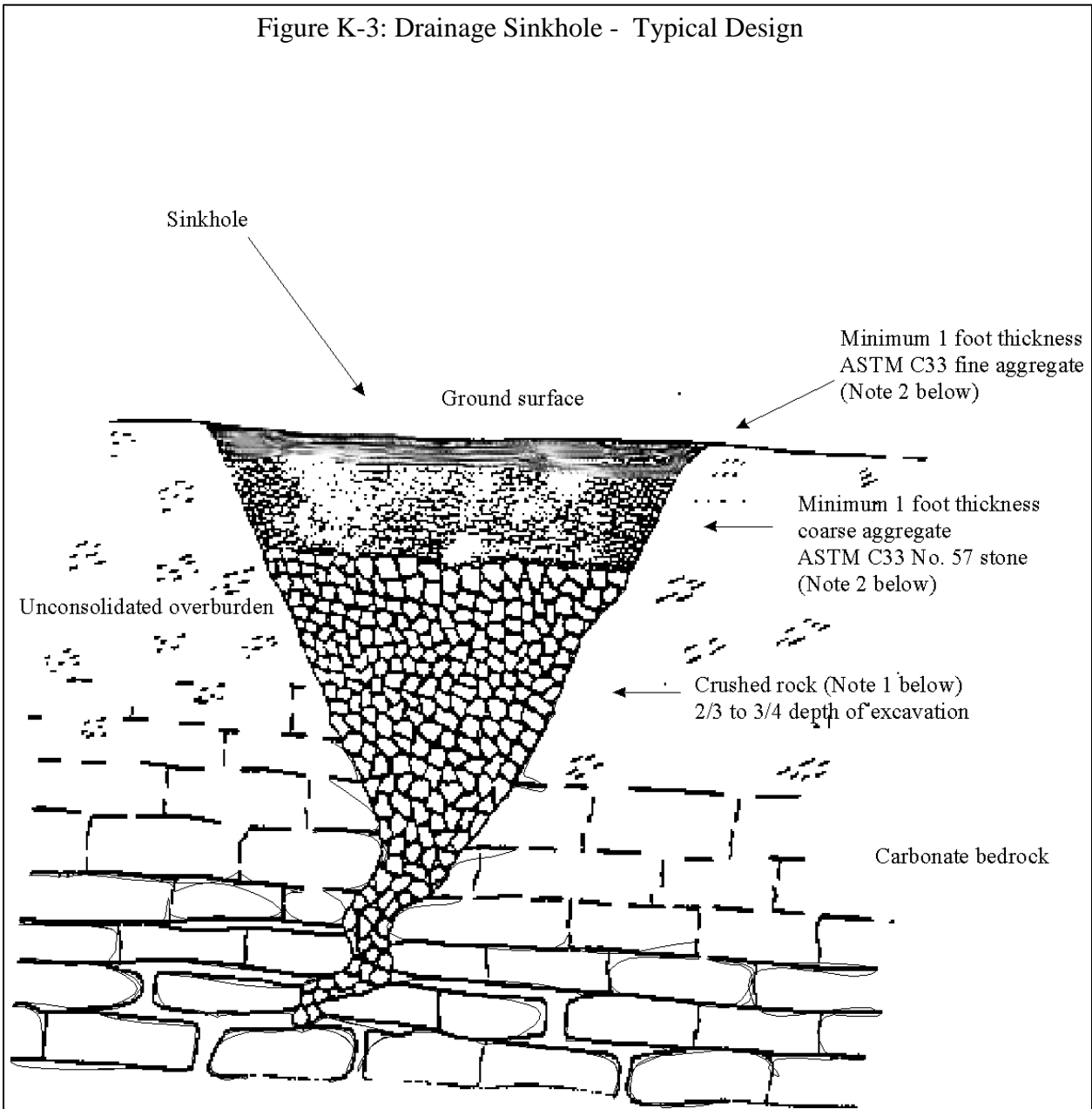

Note 1: National Crushed Stone Association R-3 Stone with little or no fines, maximum size 6 inches; average size 3 inches; minimum size 2 inches. Locally referred to as "gabion rock."

Note 2: ASTM C33 Grading Requirements, % Finer by Weight

Material	Sieve size									
	1 1/2 in.	1 in.	3/4 in.	1/2 in.	#4	#8	#16	#30	#50	#100
No. 57 Stone	100	95-100		25-60	0-10	0-5				
Fine aggregate			100		95-100	80-100	50-85	25-60	10-30	2-10

Drainage Sinkhole - Typical Design

Figure K-4: Sinkhole Plug with Inverted Filter – Typical Design

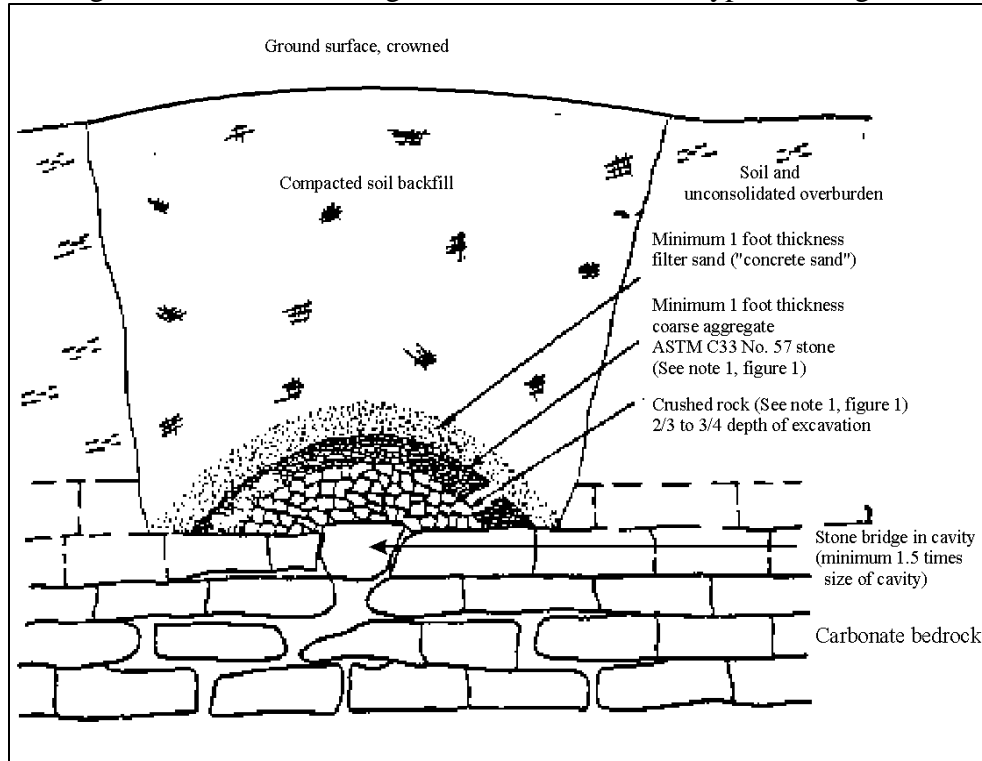

Figure K-5: Slurry Grouting Treatment Method

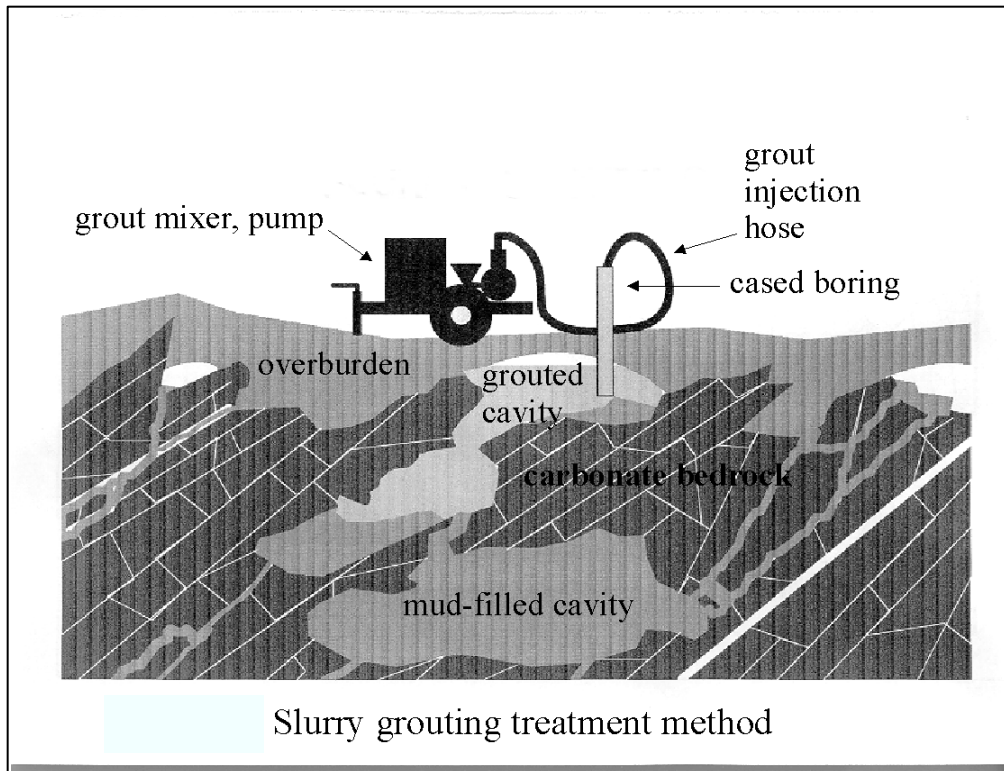
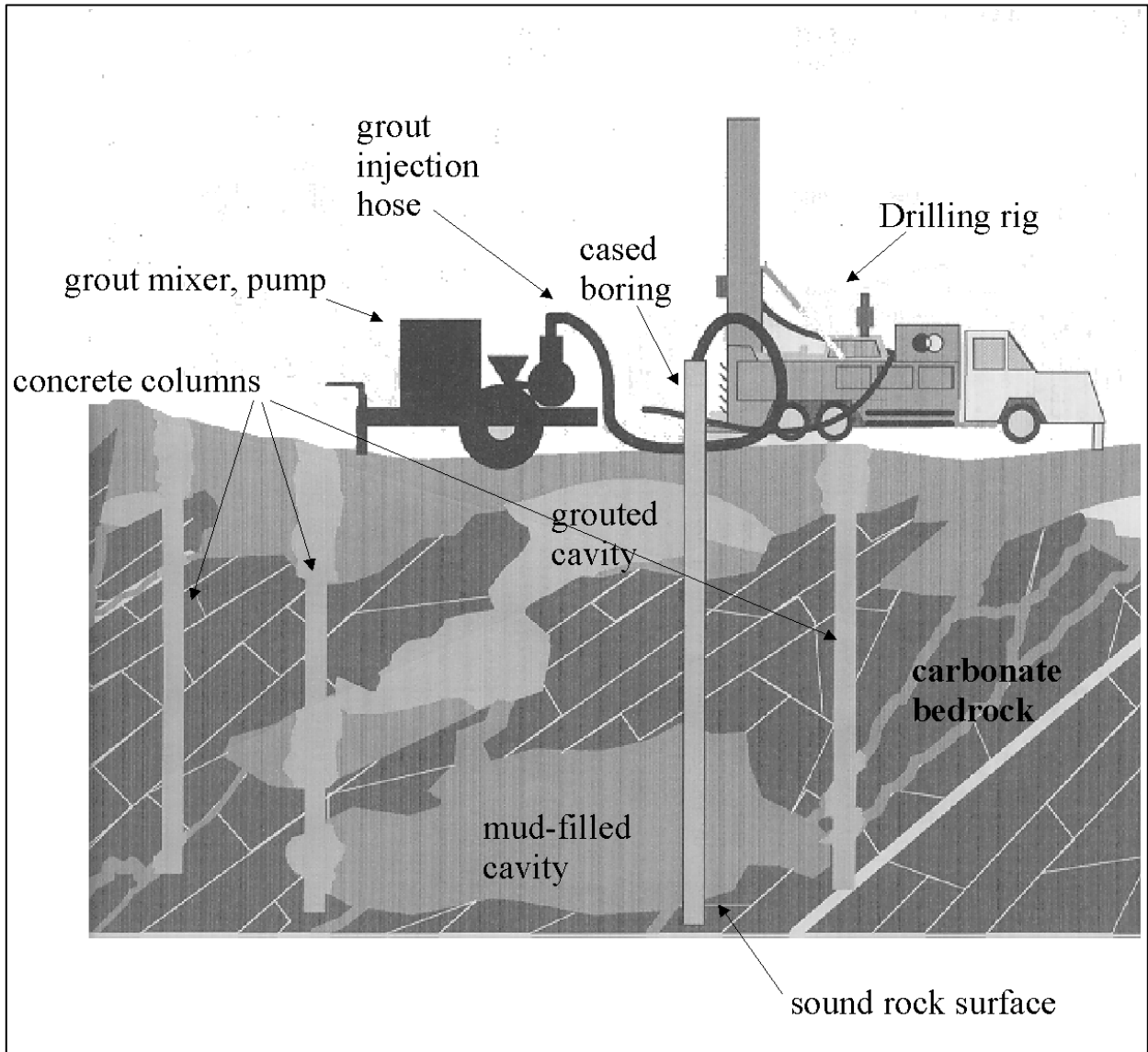

Figure K-6: Cavity Treatment Grouting Method



Selected References

American Society for Testing and Materials, 1997, Standard C143/C143M-97, Standard test method for slump of hydraulic cement concrete, West Conshohocken, PA.

American Society for Testing and Materials, 1997, Standard C144-97, Standard specification for aggregate for masonry mortar, West Conshohocken, PA.

American Society for Testing and Materials, 1997, Standard C150-97e1, Standard specification for Portland Cement, West Conshohocken, PA.

National Crushed Stone Association, 1978. Quarried stone for erosion and sediment control, Manufactured products of the crushed stone industry, V. 2, Site work, drainage/marine work, Washington, D.C.

U.S. Department of Agriculture (USDA), Natural Resources Conservation Service, 1995. Sinkhole and sinkhole area treatment. Sinkhole Treatment 370, Trenton, NJ, pp. 1-3

U.S. Dept. of Agriculture (USDA), Natural Resources Conservation Service, 1994. National engineering handbook, Part 633, Chapter 26, Gradation design of sand and gravel filters, 210-vi-NEH, Washington D.C., October 1994, 37 p. w. appendix.

U.S. Department of Agriculture (USDA), National Handbook of conservation practices, IV. Standards and practices, (stock no. 001-007-00903-1) Washington D.C.

(USDA manuals and handbooks can be obtained through the National Technical Information Service Research Department, U.S. Department of Commerce, 5285 Port Royal Road, Springfield, VA, 22161, 703-487-4780, 703-321-8541 (fax)